

ASSEMBLY INSTRUCTION

WF299096AAE

WF299097AAE

WF305088AAE

WF305089AAE

WF305090AAE

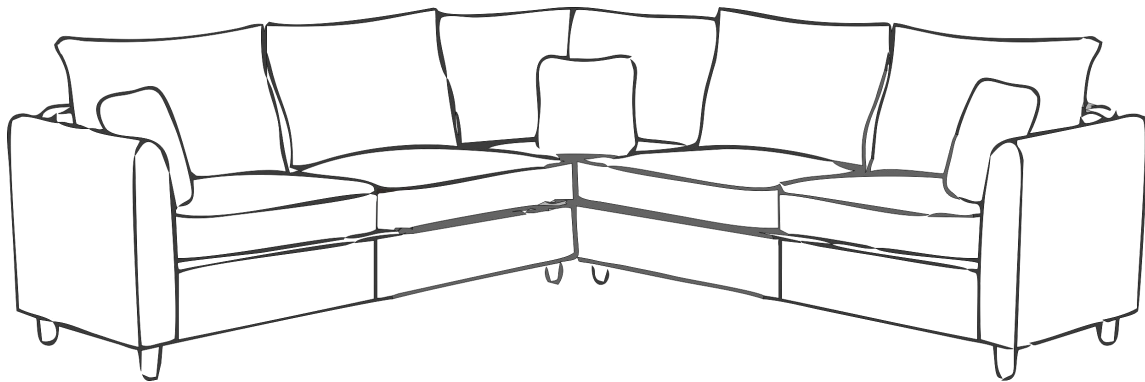



Return & Warranty policy:

-We strive to offer the highest quality products, and we also try our best to satisfy each and every customer that orders from us with replacement parts or service as needed.

-If the item is damaged or defective, please take photos as evidence for replacements and refunds.

-Please do not return to store, contact the seller if you have any troubles with this product.

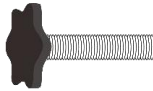
ASSEMBLY INSTRUCTION

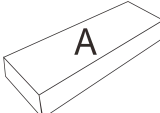
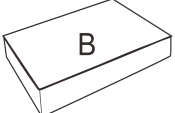

HARDWARE			
NO	DESCRIPTION	SKETCH	QTY
1	Torx Screws 8x45		21
2	Torx Screws 8x60		4
3	Feet Decals 40x3		8

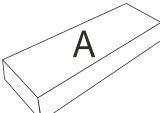
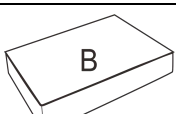
PARTS LIST WF299096AAE			
NO	DESCRIPTION	SKETCH	QTY
A	Side Seat Frame		1
B	Cushions		2

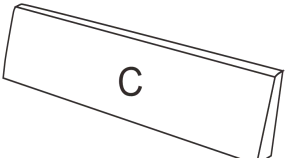
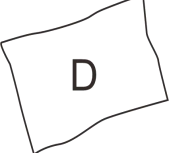
PARTS LIST WF299097AAE			
NO	DESCRIPTION	SKETCH	QTY
A	Side Seat Frame		1
B	Cushions		2

PARTS LIST WF305088AAE			
NO	DESCRIPTION	SKETCH	QTY
C	Side Backrest		2
D	Back Cushions		4

PARTS LIST WF305089AAE

NO	DESCRIPTION	SKETCH	QTY
F	Left Arm		1
G	Right Arm		1
L	Corner Back Cushions		2

PARTS LIST WF305090AAE



NO	DESCRIPTION	SKETCH	QTY
H	Corner Seat Frame		1
I	Corner Cushions		1
J	Corner L Backrest		1
K	Corner R Backrest		1
E	Pillows		3
M	Plastic Legs		8

DIAGRAM 1

Take the back cushions (Parts D) out of the Backrest (Parts C); take the back cushions (Parts L) out of the Arms (Part F and Part G); take the pillows (Parts E) out of the Backrest (Part J and Part K).

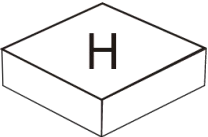
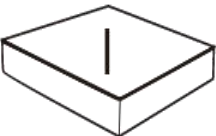
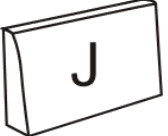
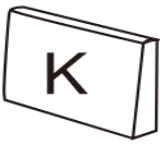
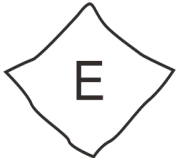
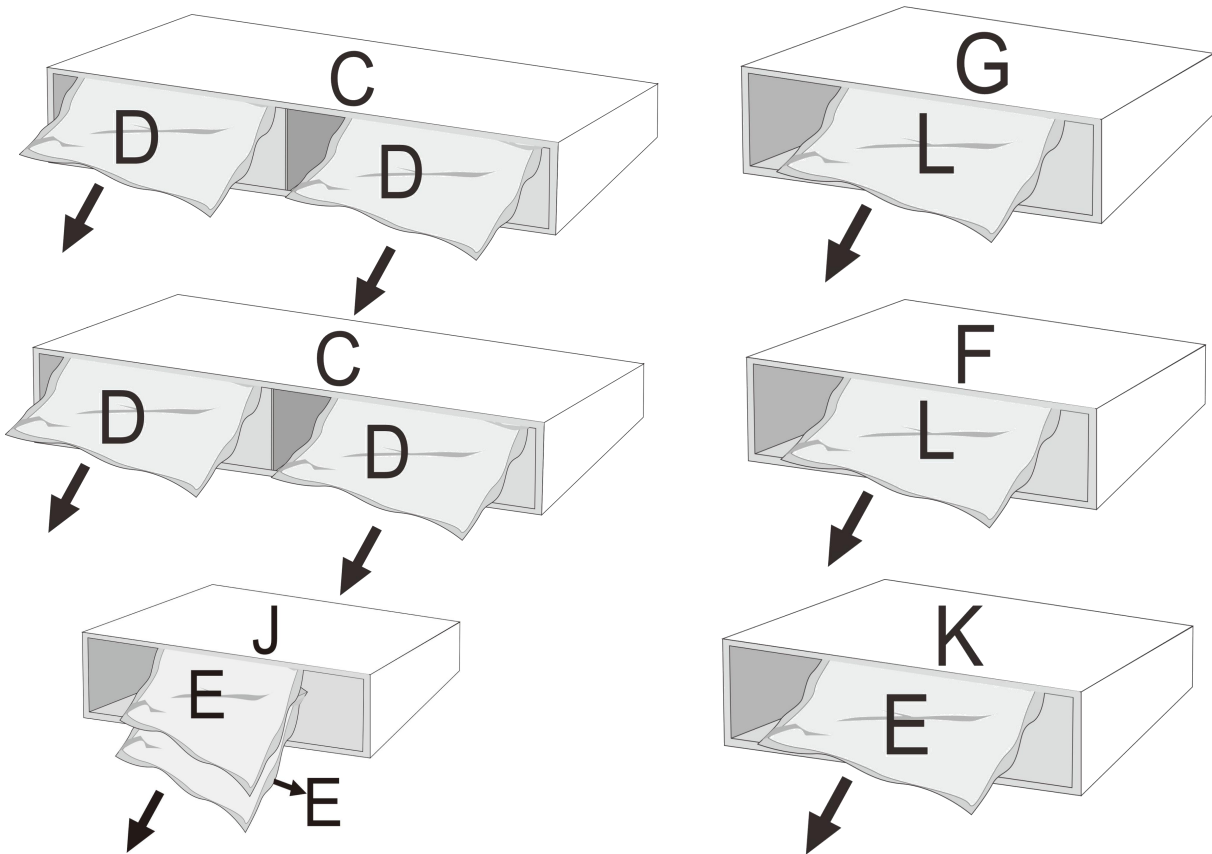

DIAGRAM 2

All parts and hardware.

1		21 PCS
2		4 PCS

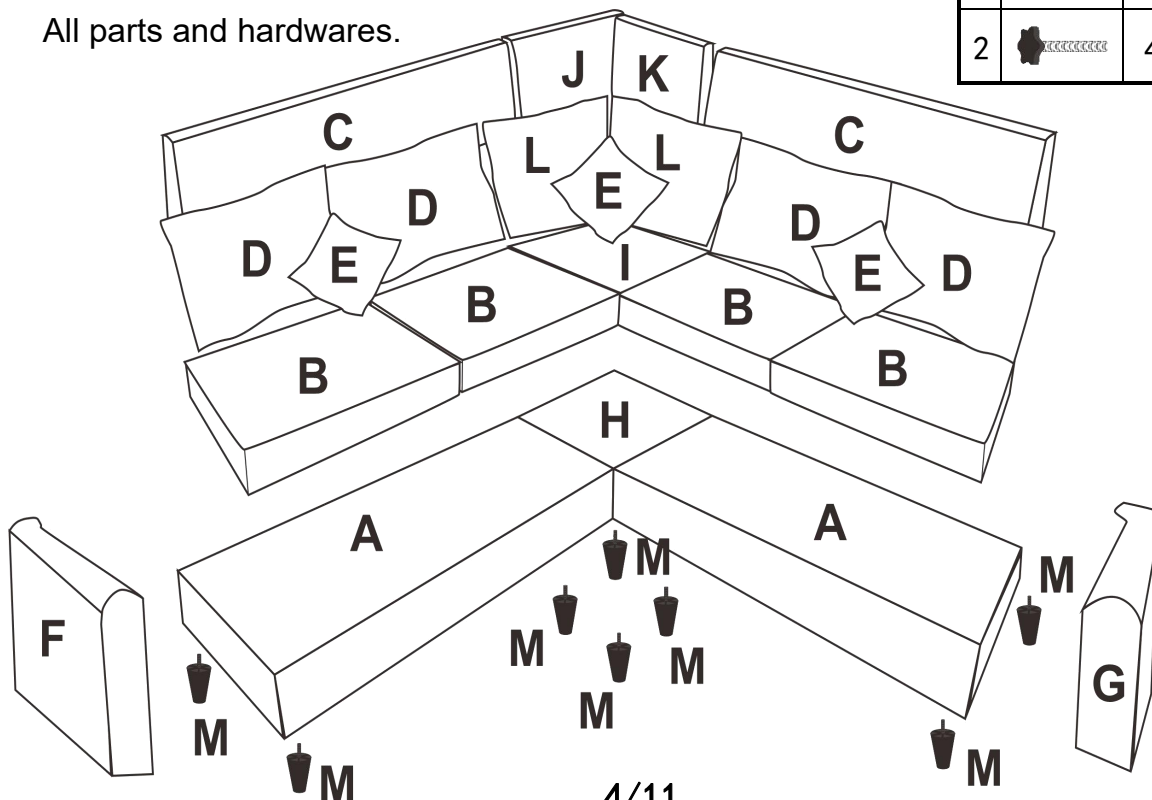

DIAGRAM 3

Connect the Seat Frames (Parts A) and the Backrests (Parts C). Tighten the screws by clockwise.

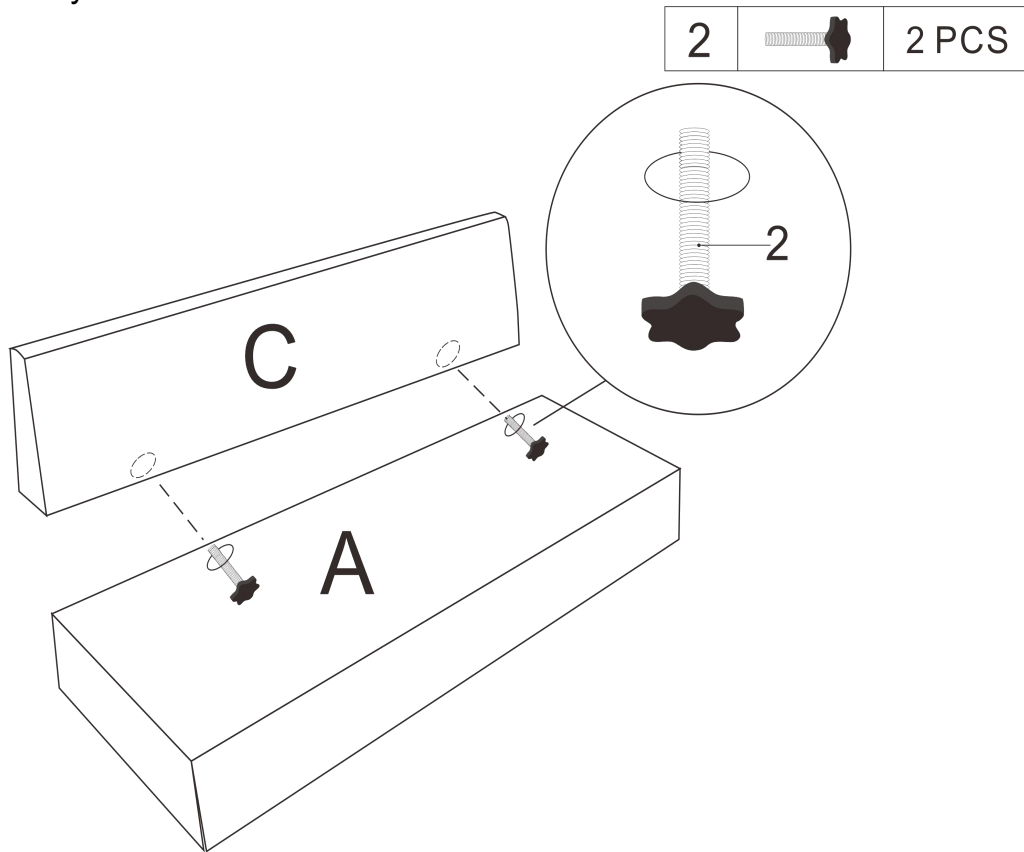

DIAGRAM 4

Connect the Seat Frames (Parts A), Backrests (Parts C) and the Arm (Part F). Tighten the screws by clockwise.

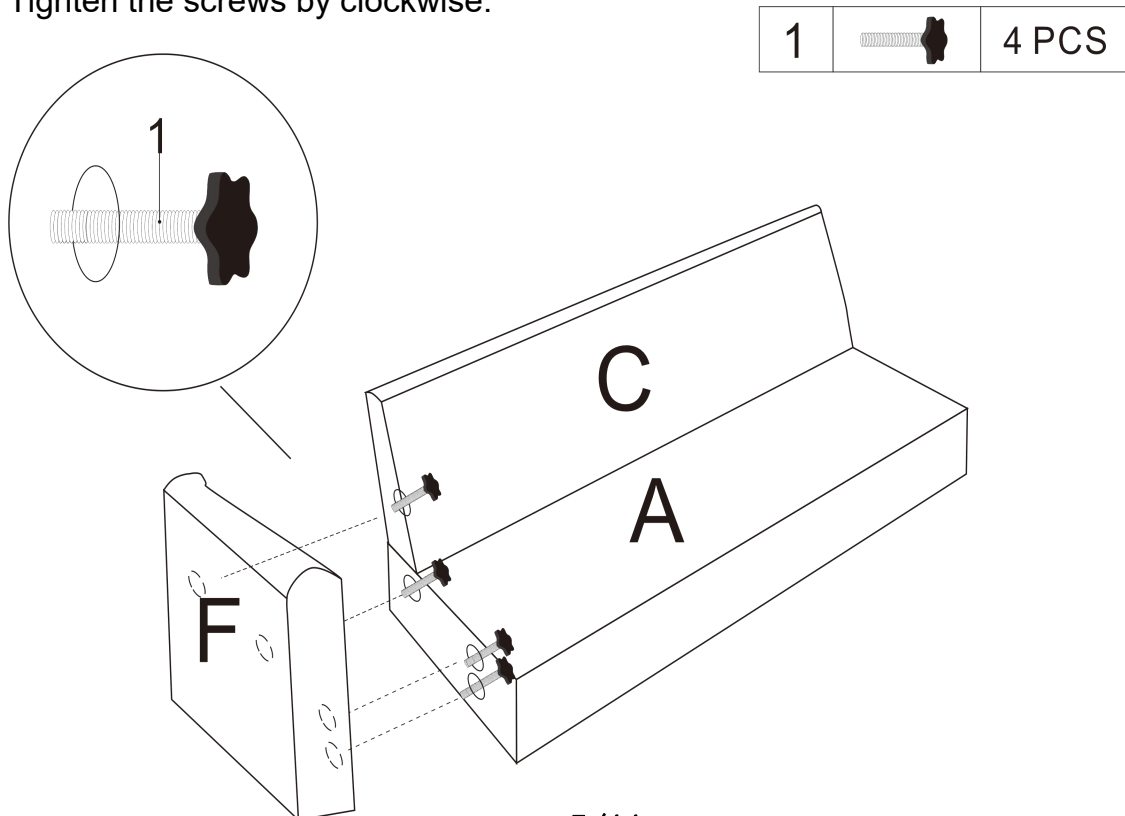



DIAGRAM 5

Tighten 2 legs (Parts M) by clockwise one by one, stick the feet decal (3) onto each leg.

M		2 PCS
3		2 PCS

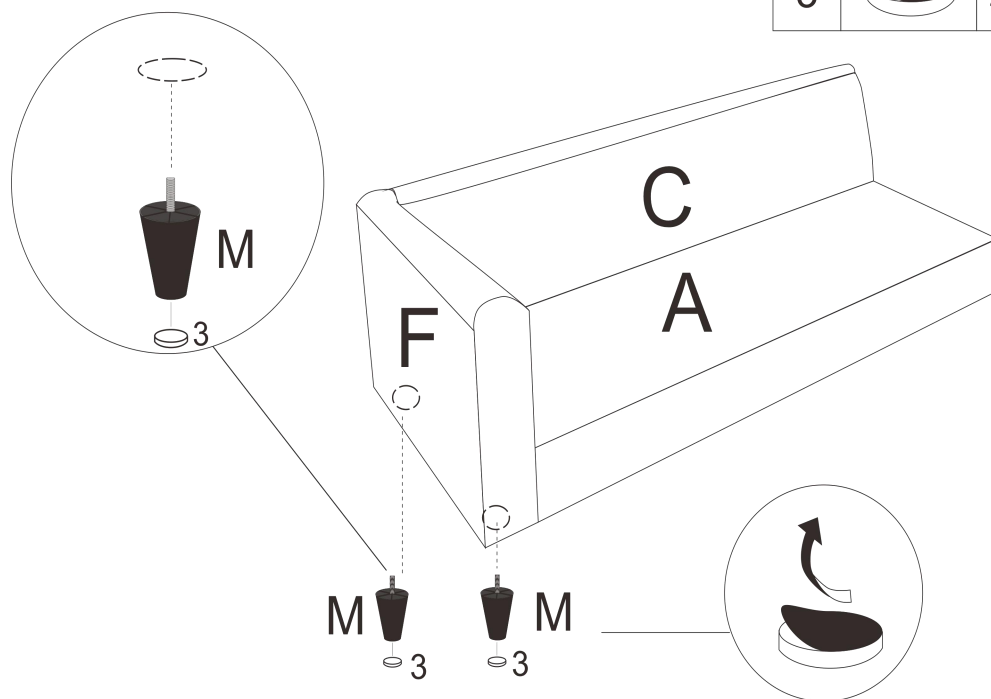

DIAGRAM 6

Connect the Seat Frames (Parts A) and the Backrests (Parts C). Tighten the screws by clockwise.

2		2 PCS
---	---	-------

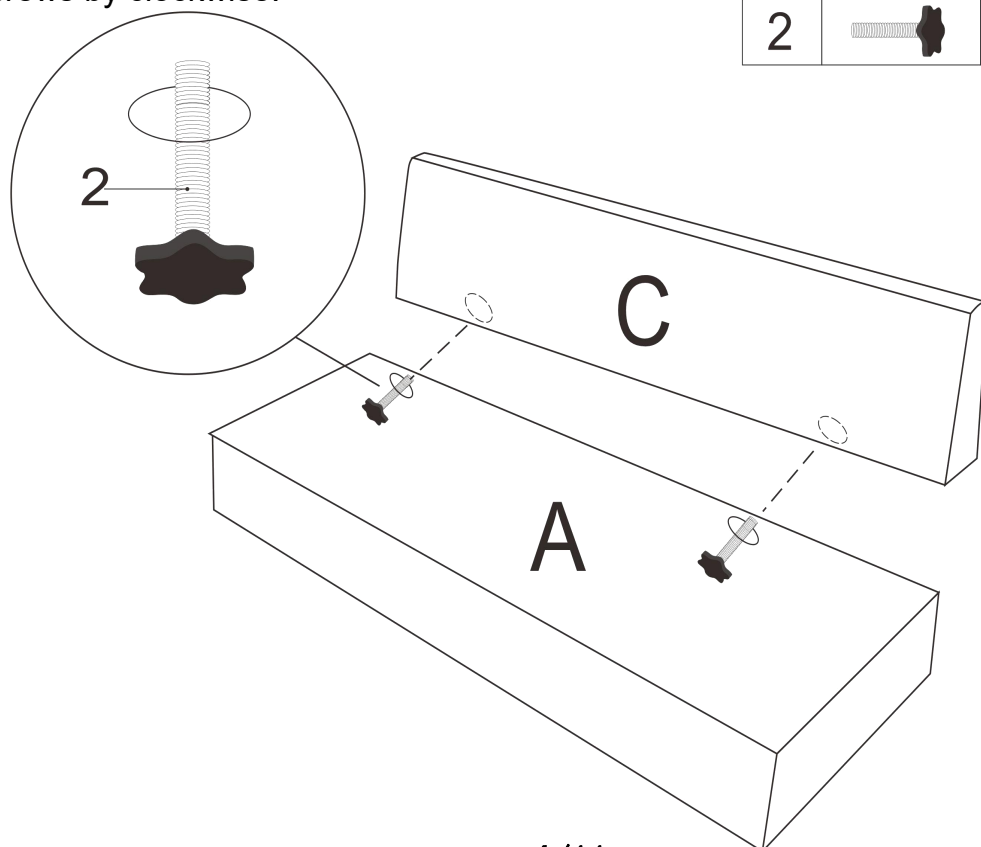

DIAGRAM 7

Connect the Seat Frames (Parts A), Backrests (Parts C) and the Arm (Part G).
Tighten the screws by clockwise.

1		4 PCS
---	---	-------

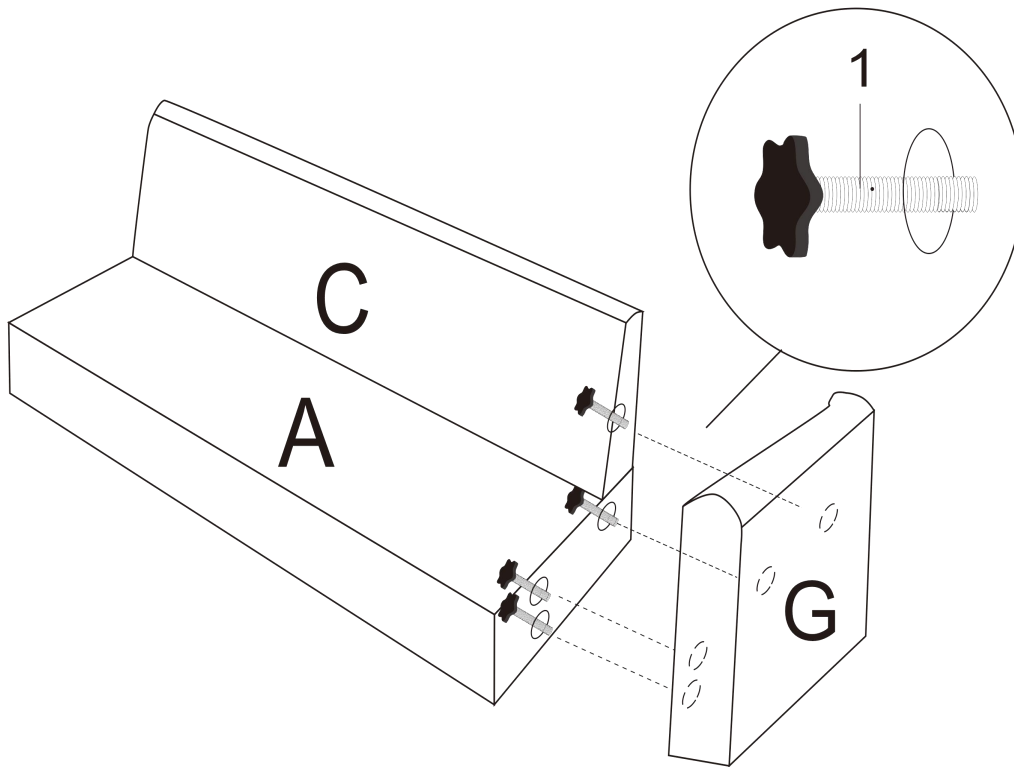



DIAGRAM 8

Tighten 2 legs (Parts M) by clockwise one by one, stick the feet decal (3) onto each leg.

M		2 PCS
3		2 PCS

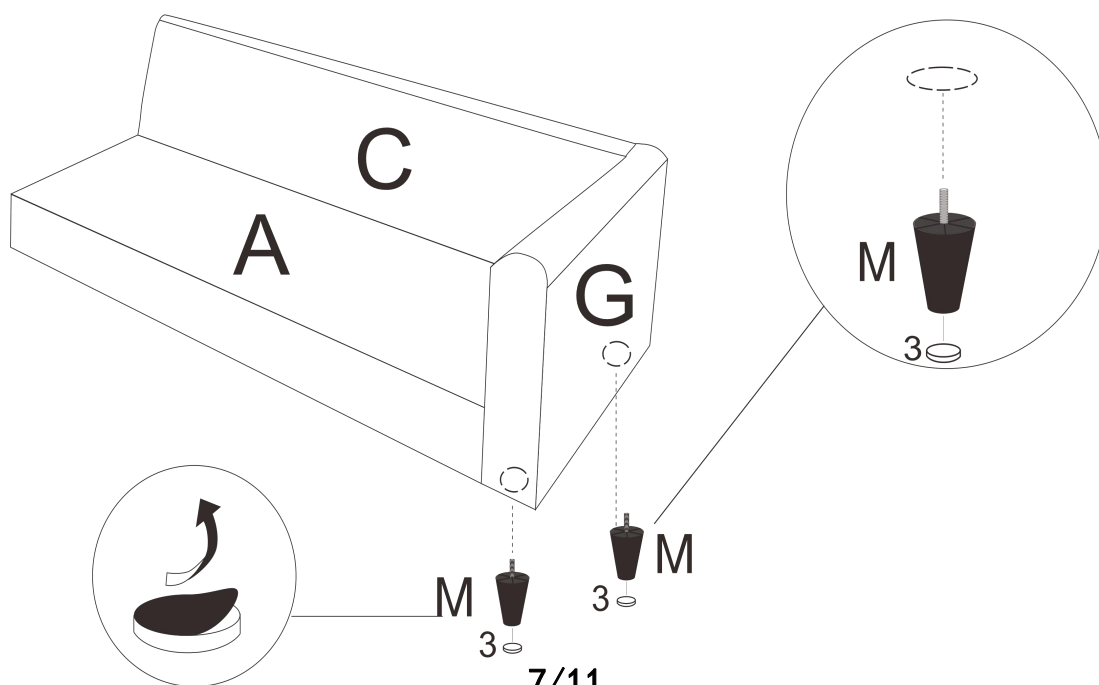

DIAGRAM 9

Connect the Seat Frame (Part H) and the backrest (Part J and Part K). Tighten the screws by clockwise.

1		5 PCS
---	---	-------

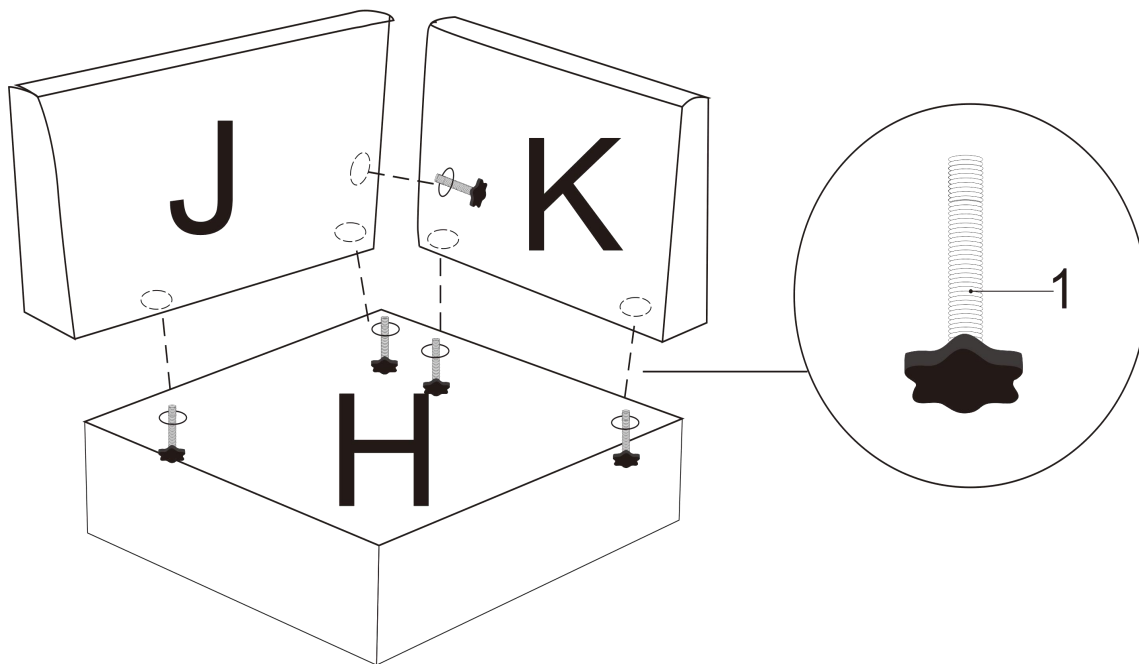



DIAGRAM 10

Tighten 4 legs (Parts M) by clockwise one by one, stick the feet decal (3) onto each leg.

M		4 PCS
3		4 PCS

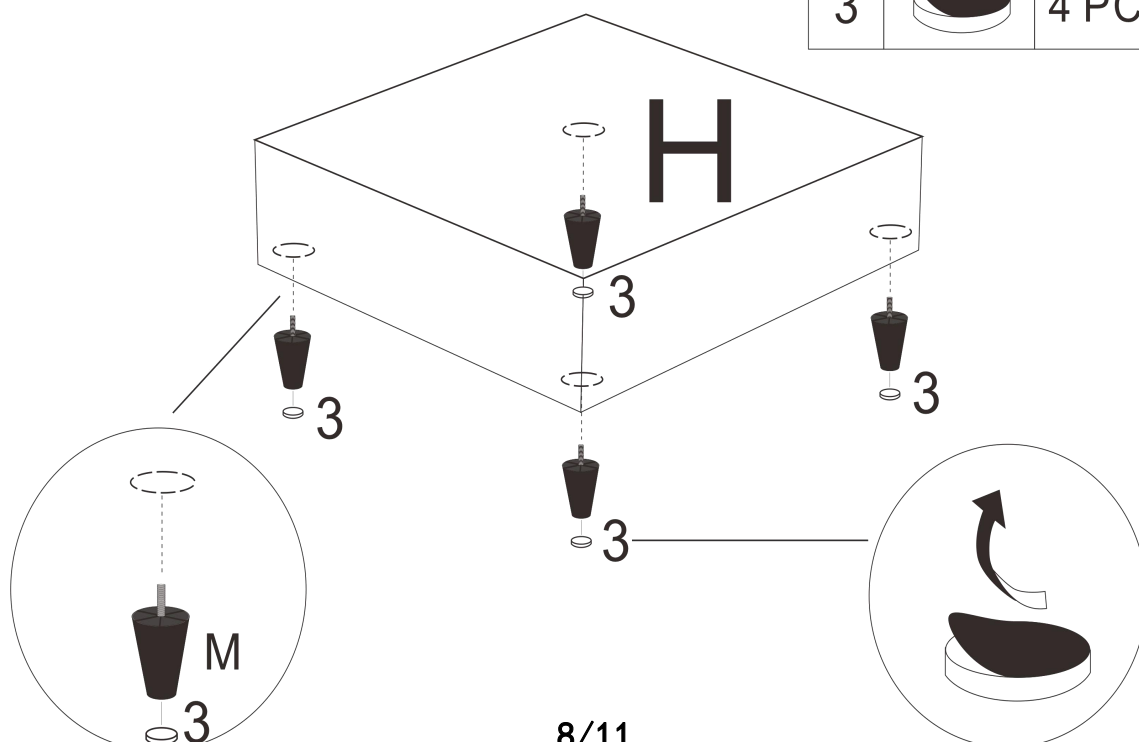

DIAGRAM 11

Connect the sofas with the corner. Tighten the screws by clockwise.

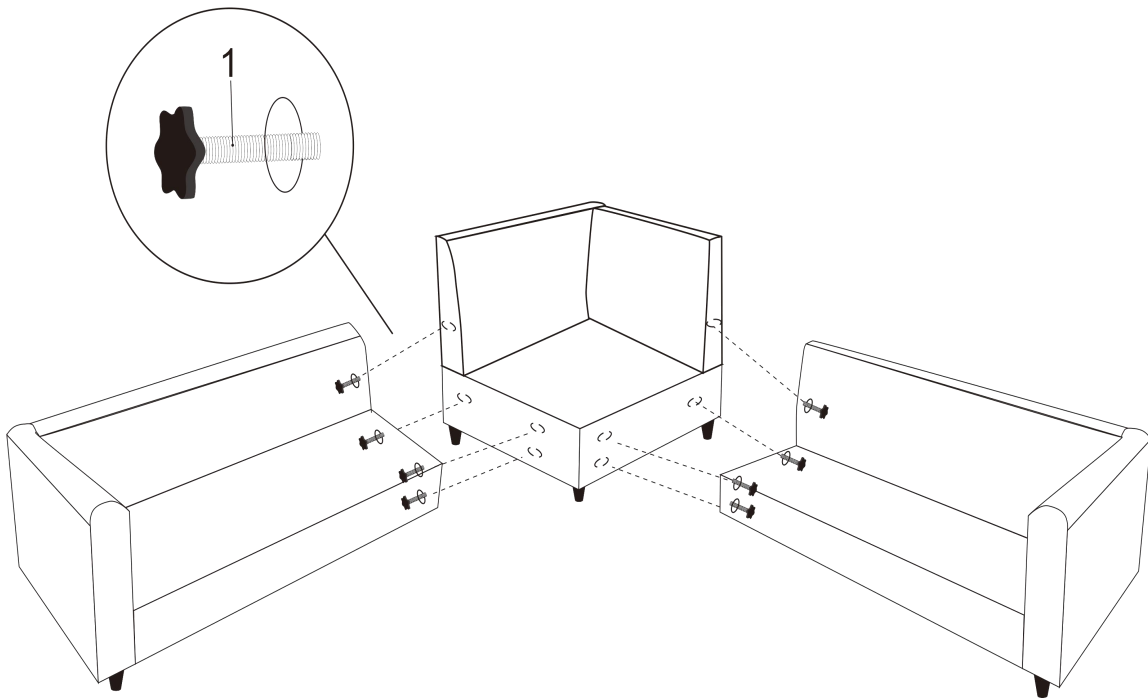
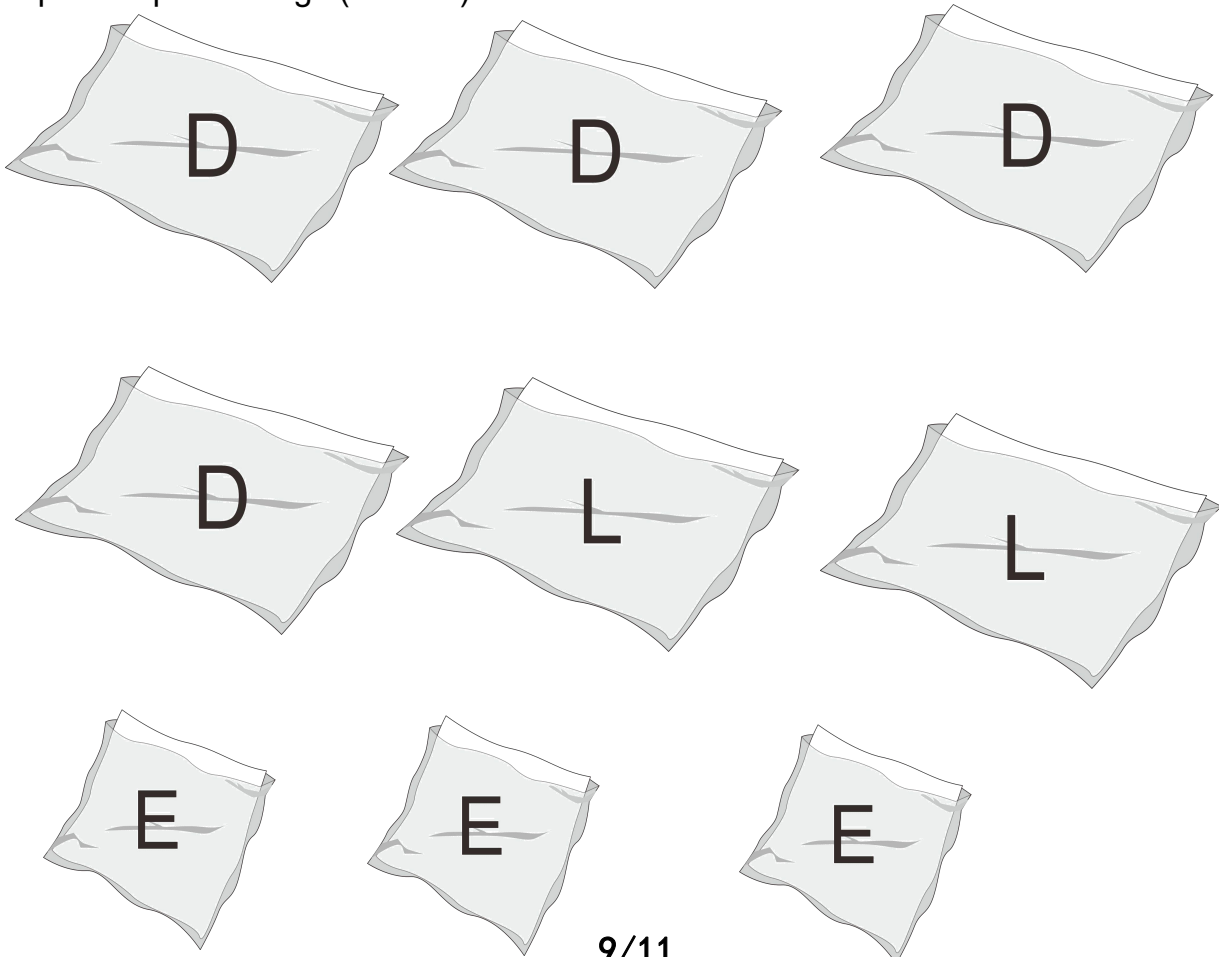

DIAGRAM 12

Remove the back cushions' plastic bags (Parts D and Parts L); remove the pillows' plastic bags (Parts E).



Tips:

1. Please do not open the compress packaging until your sofa frame is completely assembled.
2. Compress back cushions and pillows need to be fully fulfilled within 72 hours for your perfect use.
3. Please keep children away from plastic bags or any small pcs of stuff.

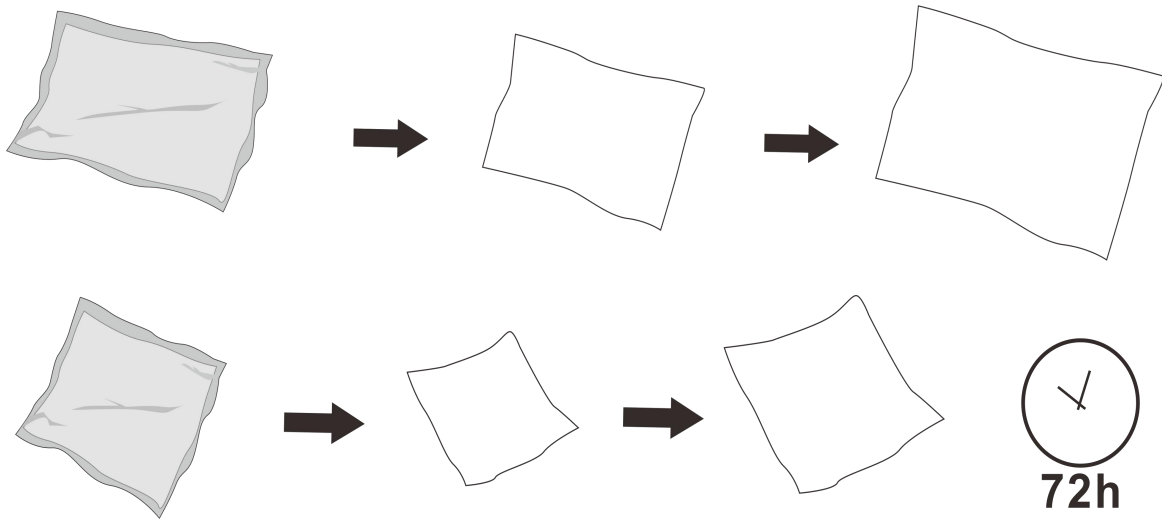
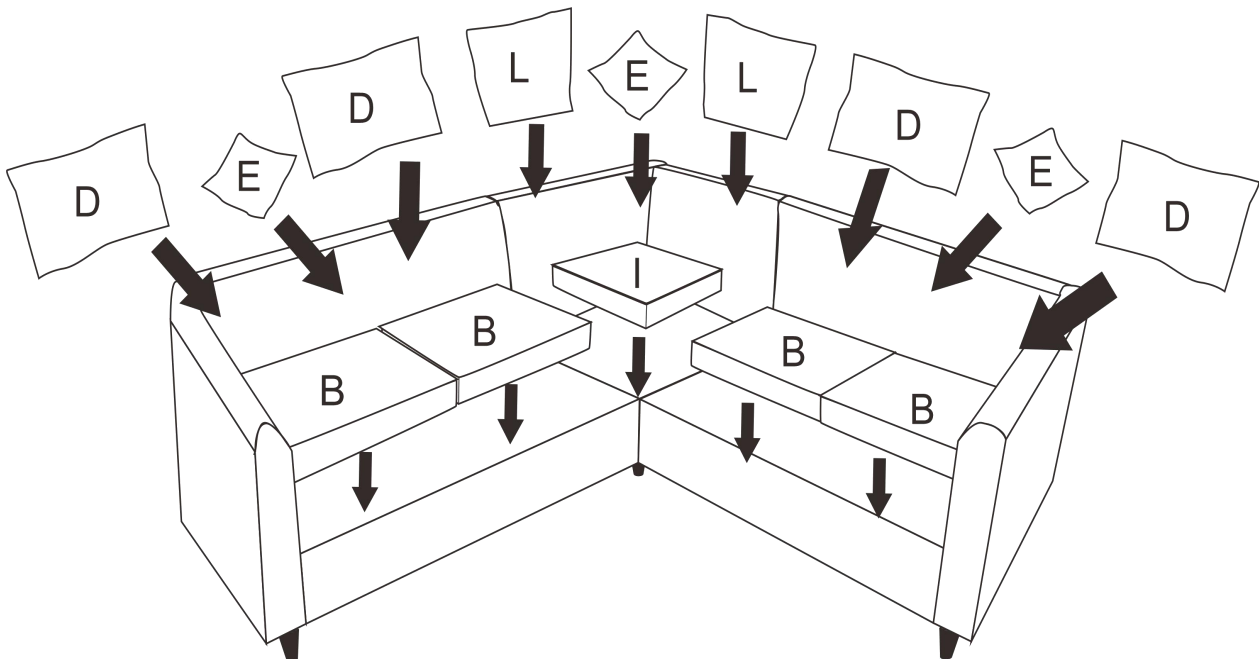

DIAGRAM 13

Put the seat cushions (Parts B and Part I), the back cushions (Parts D and Parts L) and the pillows (Parts E) on the sofa.
Recheck all the bolts before you sit on the sofa.



COMPLETE

