

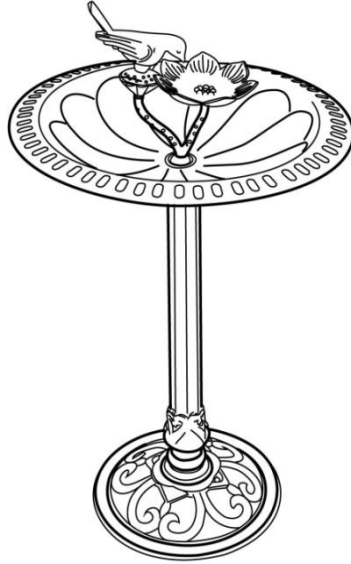



Assembly Instructions

Caution : You must read this before you proceed





Bird Bath



Parts List

Label	Picture	Description	QTY
A		Bird on Lotus	1
B		Water Basin	1
C		Pedestal	1
D		Base	1

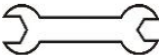



Hardware

Label	Picture	Description	QTY
①		Bolt (M8*10MM)	4
②		Bolt (M6*15MM)	4
③		Bolt (M8*25MM)	2
④		Spanner	1
⑤		Washers(M6)	4
⑥		Rubber Gasket	1

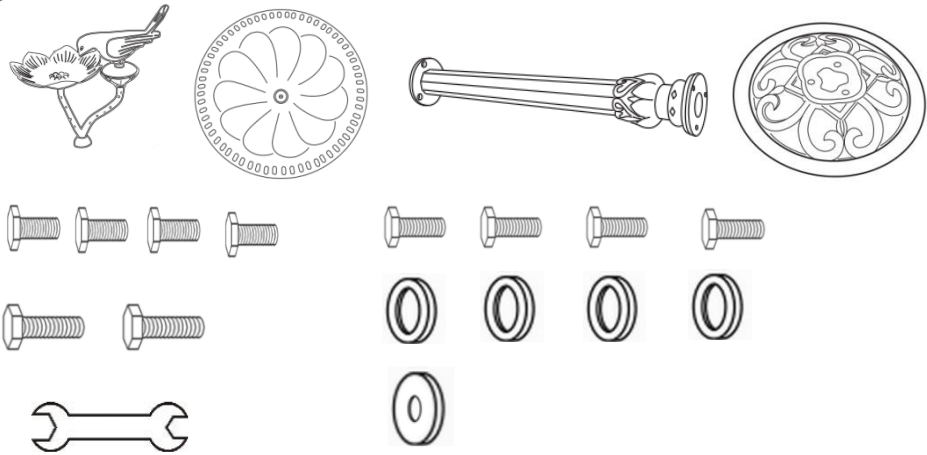
Assembly Preparation

Before Beginning Assembly:



-  • Read instructions, cover to cover-
-  • Have 2 adults on hand for assembly-
-  • Do not assemble on flooring or carpet-
-  • Assemble on a clean non-marring surface (packing foam)-
-  • Save all packaging until finished-

Assembly Steps

Overview

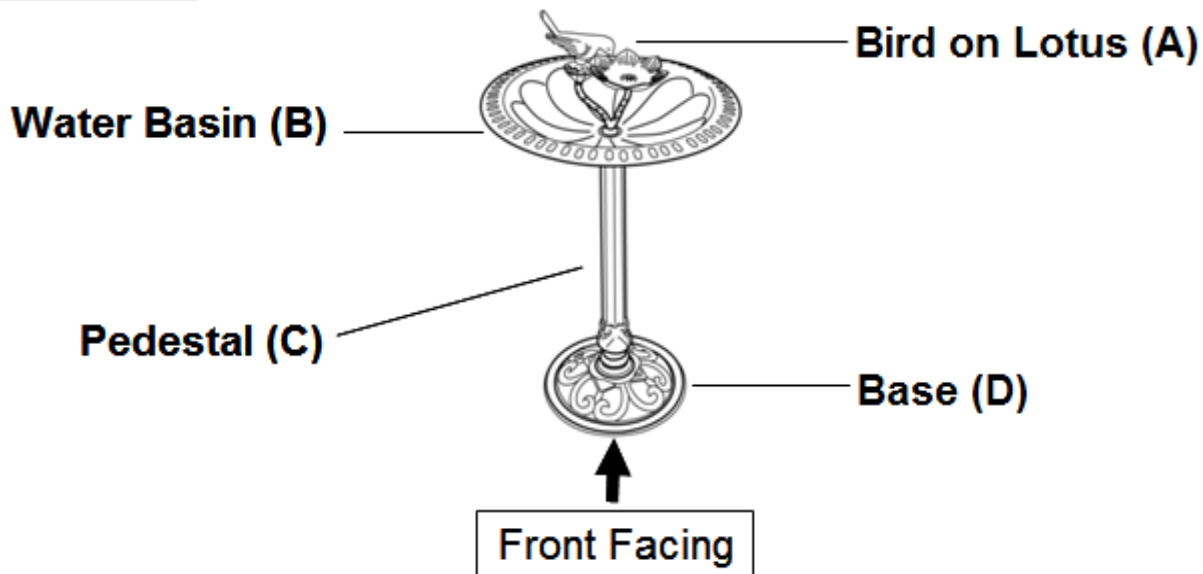

This Bird bath has multiple parts and may require up to 30 minutes or more to assemble. To give you an overview of the Bird bath, the above picture is to help you put the various parts into perspective. Please read through the instructions below to familiarise yourself with the parts and steps before assembly.

Step 1

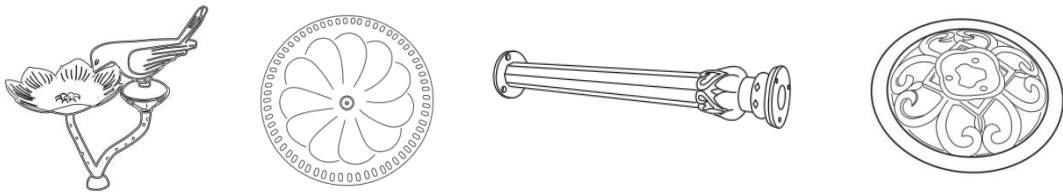

Unpack and place all parts on a clean, non-marring surface.

Step 2

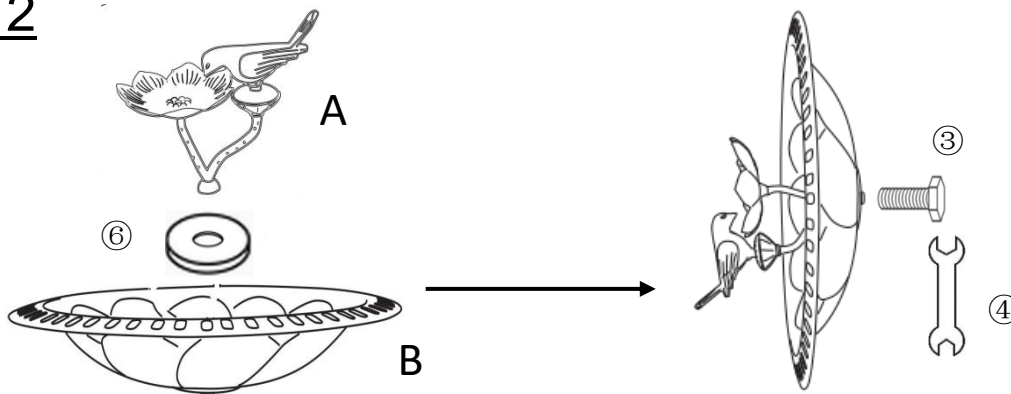

Align the mounting positions on Bird on Lotus(A) and Water Basin(B).
Attach Bird on Lotus (A) to Water Basin (B) using Rubber Gasket(6) and Bolt(3) by Spanner(4).

Fully tighten the Bolt.

Step 3

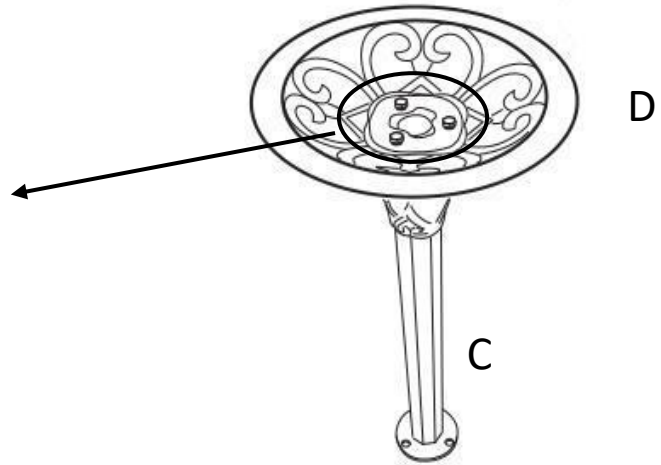
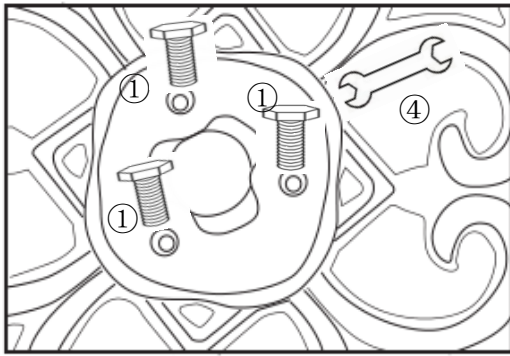

Align the mounting positions on Pedestal(C) and Base(D), then using the Bolt(①) by Spanner(④).
Fully tighten the Bolts.

Step 4

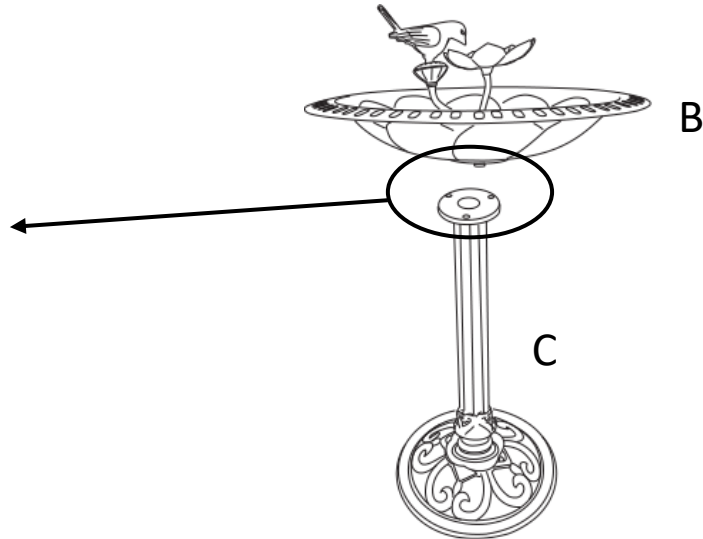
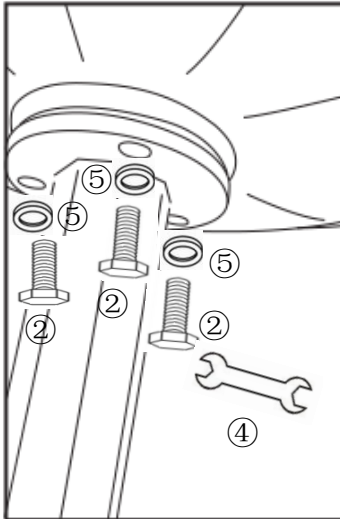

Attach the Pedestal(C) to Water Basin(B) by using the Bolts(②)and Washers(⑤) with Spanner(④).

Then proceed to tighten all Bolts at all joints in a sequential manner.



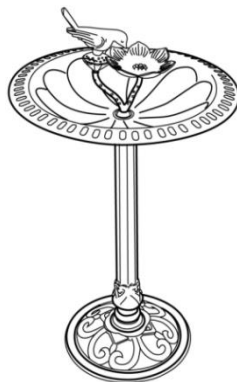





Step 5



Your Bird bath is ready for use.

This Bird bath can only be used on a flat, level surface.

Care & Maintenance

-  Do not put hot items directly on furniture surface.
 -  Do not clean furniture with harsh cleansers or polish.
 -  To obtain the longest lifespan of your outdoor products, minimizing exposure to direct sunlight is recommended.
 -  Children should not climb or jump on the furniture.
 -  Do not write on furniture without a padded barrier to protect the surface.
 -  To obtain the longest lifespan of your outdoor products, avoid extended and lengthy exposure to rain, snow, and direct sunshine. Whenever possible cover the product and /or place under patio or awnings.
 -  Not for commercial use. For residential use only .
 -  Stains may be removed with mild soap solution and damp cloth.
-
-  Dust and pick-up spills using a clean, non-colored, lint-free cloth .