

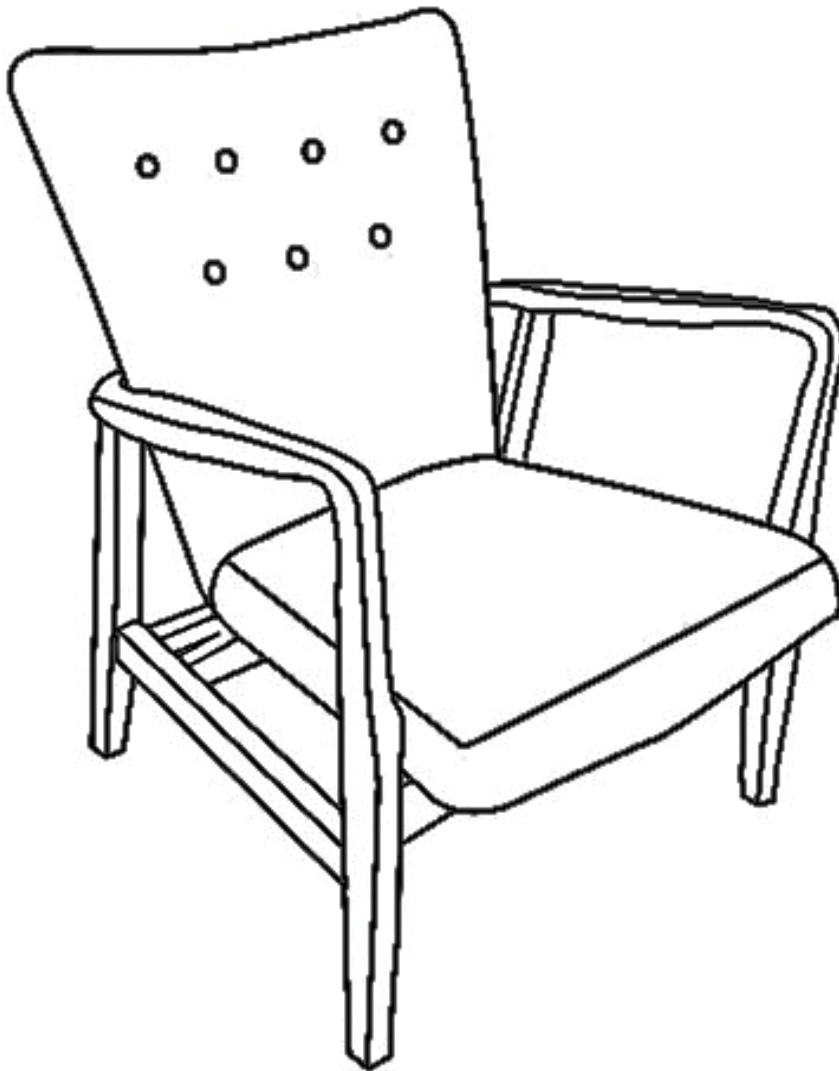

Assembly Instructions

Caution : You must read this before you proceed





Arm Chair

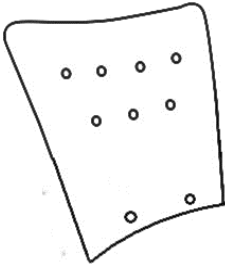
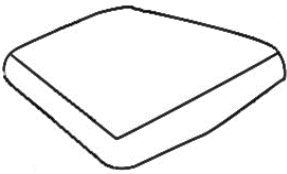

Parts List

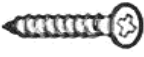
Label	Picture	Description	QTY
A		Frame	1
B		Back	1
C		Seat	1

Hardware

Label	Picture	Description	QTY
①		Bolt (M8*70MM)	3
②		Screw (M4*40mm)	7
③		Spring Washer	3
④		Washer	3
⑤		Allen Key	1
⑥		Screwdriver	1

Assembly Preparation

Before Beginning Assembly:

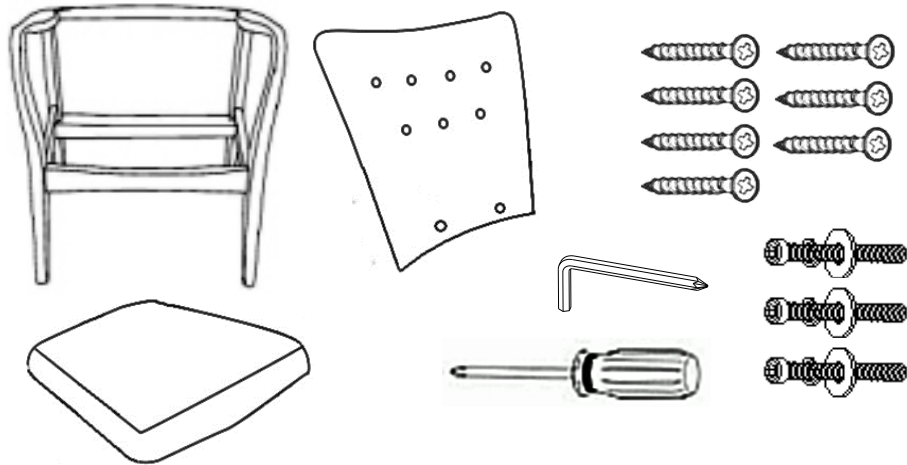

• Read instructions, cover to cover-



• Have 2 adults on hand for assembly-



• Do not assemble on flooring or carpet-



• Assemble on a clean non-marring surface (packing foam)-



• Save all packaging until finished-

Assembly Steps

Overview

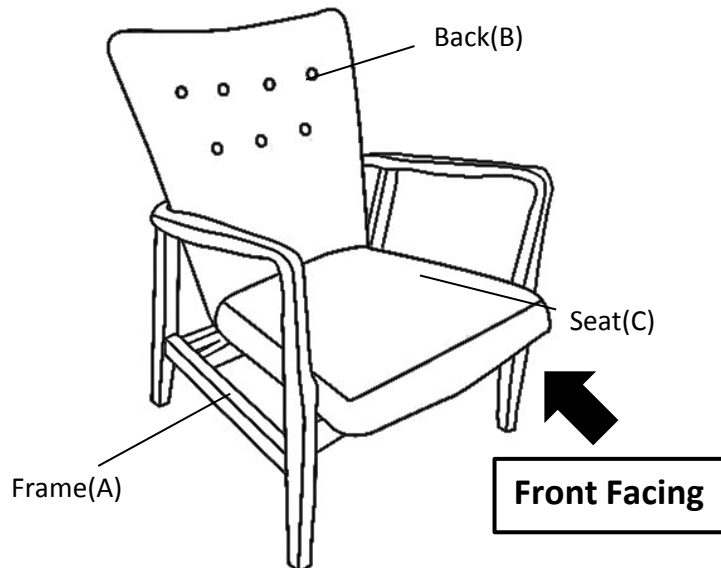

This Arm Chair has multiple parts and may require up to some 30 minutes to assemble. To give you an overview of the Arm Chair parts, the above picture is to help you put the various parts into perspective. Please read through the instructions below to familiarise yourself with the parts and steps before assembly.

Step 1

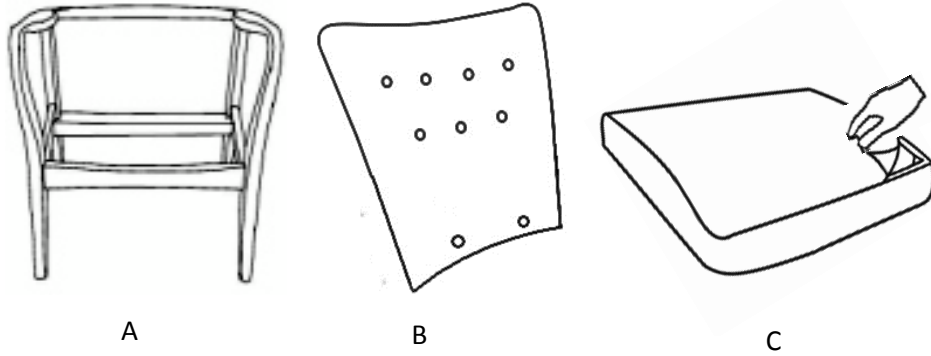

Place the Frame(A), Back(B) and Seat(C) on a clean, non-marring surface.
Carefully peel away the Dust Cover from the edge.

Step 2

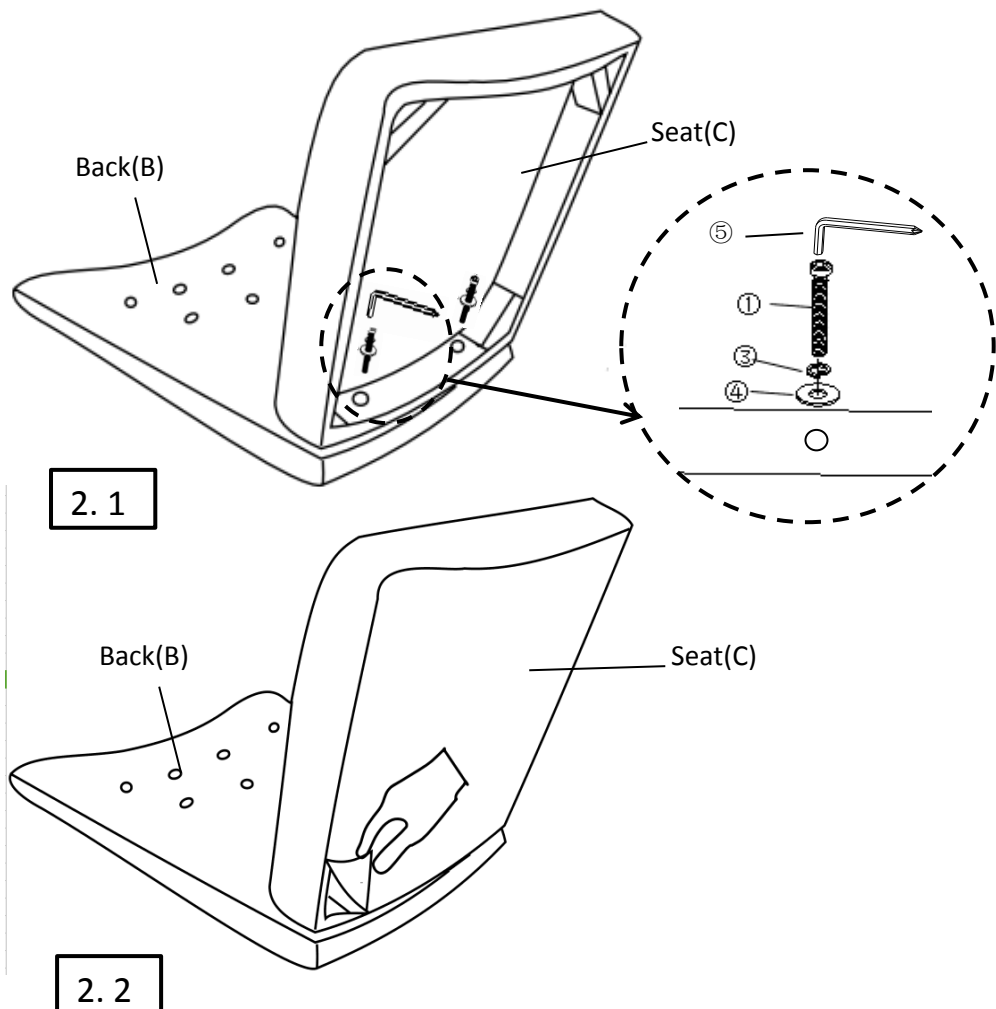

Put the Back(B) onto a clean, non-marring surface.

2.1) Align the mounting positions of the Back(B) with Seat(C) and attach them using Bolts(①), Spring Washers(③) and Washers(④) with Allen Key(⑤).

Friendly notice:

If the mounting positions cannot be aligned well and hinder the installation, then sway the Seat(C) lightly when locking the Bolts, this action could help prevent the Bolts from getting stuck and ensure smooth assembly.

2.2) Tighten the Bolts fully in a sequential manner; and then smooth down the Dust Cover with your hands on all four edges of the Seat bottom.

Step 3

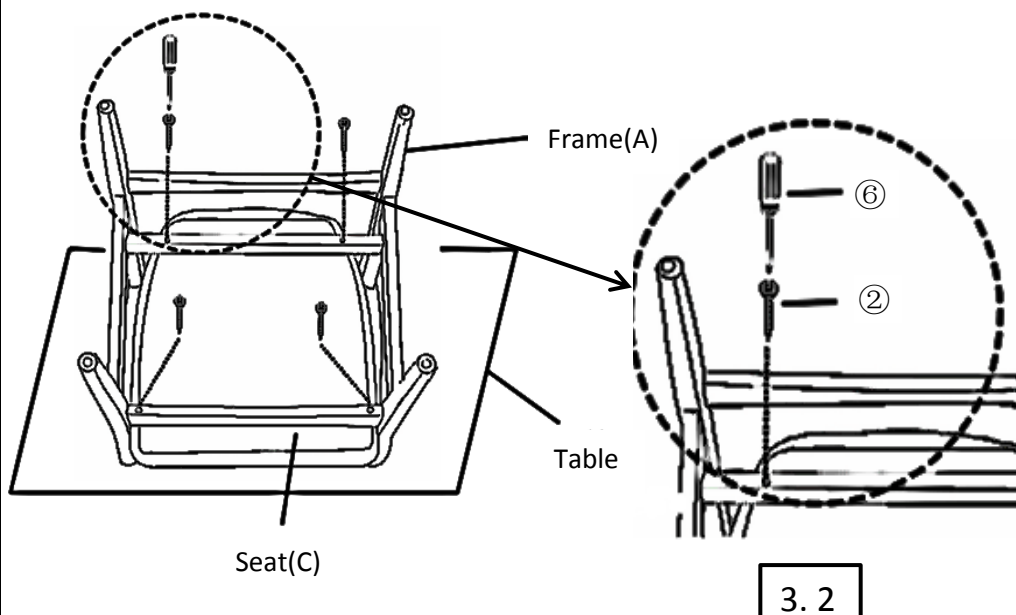
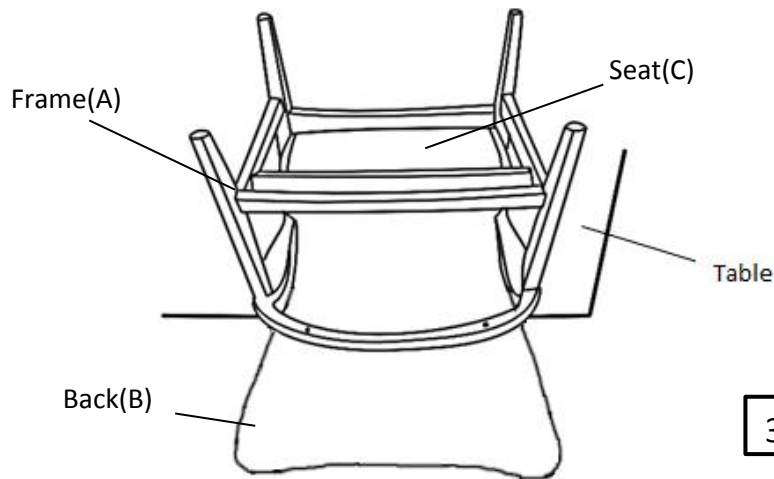

Place the assembled Seat(C) and Back(B) on the side of a table, with the Back(B) facing down.

3.1) Place the Frame(A) onto the assembled Seat(C) and Back(B) as shown in the picture.

3.2) Attach Frame(A) to Seat(C) using Screws(②) with Screwdriver(⑥).

Friendly notice:

If there are gaps between the Frame(A) and Seat(C) which hinders the Installation, then pull the Seat(C) upwards into the Frame(A), this action helps to ensure there are no gaps between them.

Do not fully tighten the Screws.

Step 4

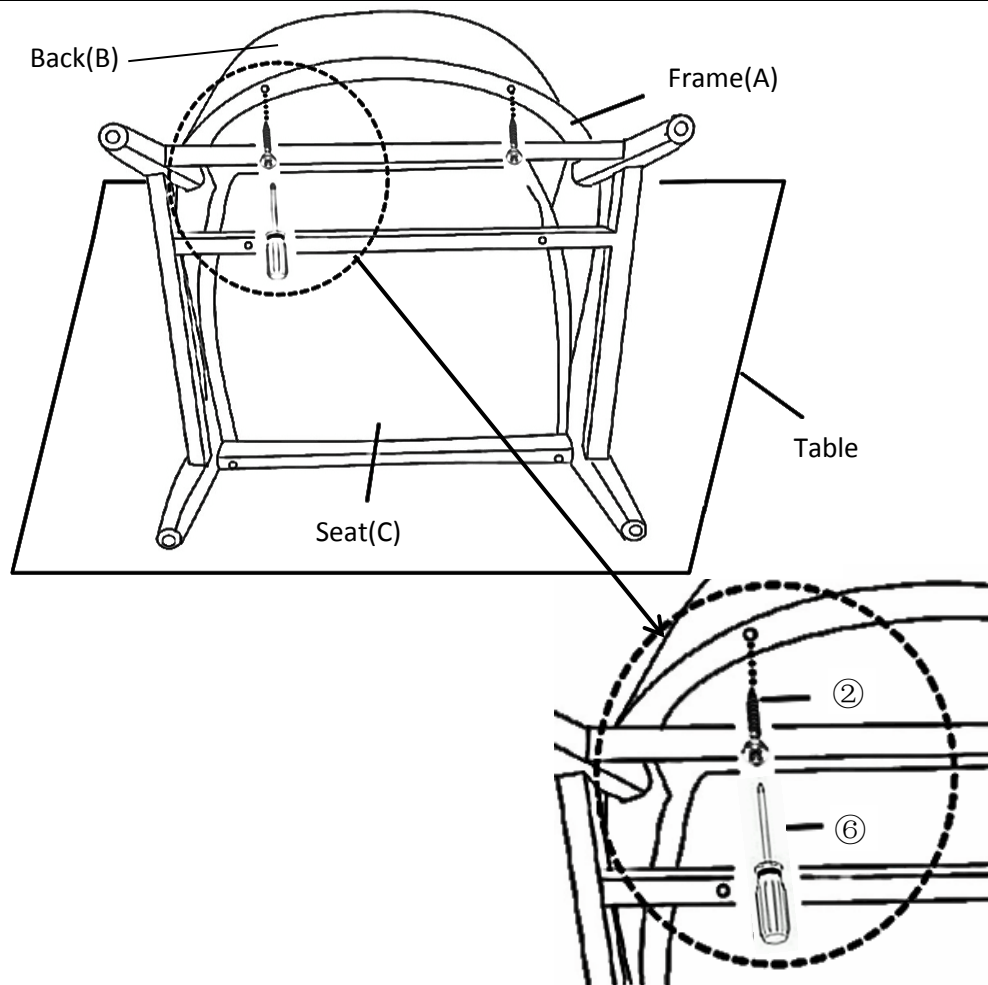

Attach Frame(A) to Back(B) using Screws(②) with Screwdriver(⑥). Please press the Back(B) to Frame(A) closely before attaching.

Do not fully tighten the Screws.

Step 5

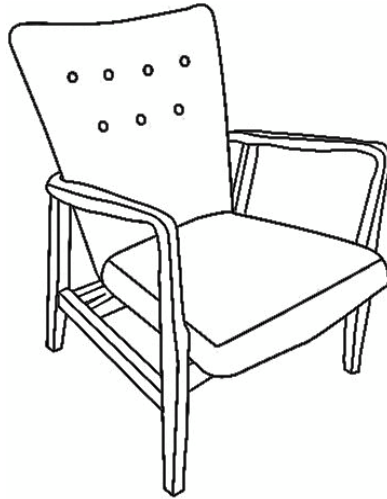

Finally, stand the Arm Chair right up, and place on a LEVEL SURFACE. Inspect it and make sure all parts are adequately connected.

Gently and gracefully, sit into the Arm Chair.

This would help to align all the parts at all the joint areas.

Then get off the Arm Chair, and place it facedown.

Tighten all Screws at all joints. Do not overtighten the Screws.

Overtightening could lead to damage to the product.

Tighten only until secure and stable.

If there is still wobbles, loosen the screws and execute this same process.



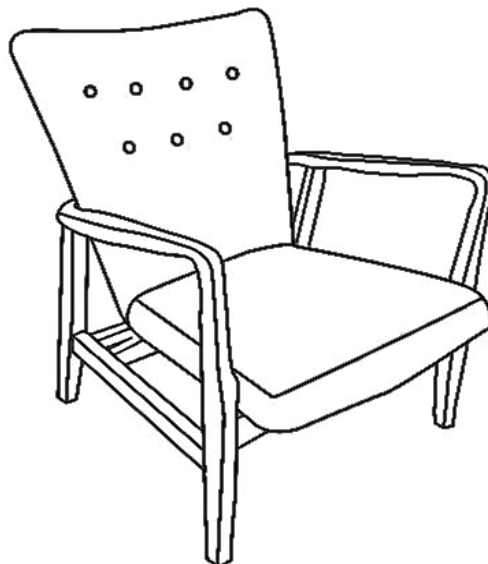

















Step 5



Your Arm Chair is ready for use.

This Arm Chair can only be used on a flat, level surface.

Care & Maintenance

-   ● Do not put hot items directly on furniture surface
 -   ● Do not clean furniture with harsh cleansers or polish.
 -   ● Do not place furniture under direct sunlight.
 -   ● Do not place furniture near heating or cooling vents.
 -   ● Do not write on furniture without a padded barrier to protect the surface.
 -   ● Do not place furniture outside . For indoor use only .
 -   ● Not for commercial use. For residential use only .
 -   ● Stains may be removed with mild soap solution and damp cloth.
 -   ● Children should not climb or jump on the furniture.
-
-   ● Dust and pick-up spills using a clean, non-colored, lint-free cloth .

What is Proposition 65?

Proposition 65 is a California law that requires warning labels on products that may contain one of more than 800-plus chemicals or ingredients that the California Office of Environmental Health Hazard Assessment (OEHHA) has deemed to cause cancer or other reproductive toxicity. Chemicals and elements on this list include wood dust, brass, and other everyday substances, which can be found in very common household items, such as: lamps, tableware, jewelry, crystal glasses, electric cords, beauty products, automobiles, and furniture.

Why Did I Find a Proposition 65 Warning on My Home Goods Product?

We include Proposition 65 warnings on all of our products because there is always a chance that one of the 800-plus common chemicals and ingredients listed under this law could potentially be on our furniture or packing materials. We risk large fines under this law, if we don't include this warning.

Should I worry?

We realize you may be worried finding this warning on our products, but we want to reassure you that the hazardous exposure limits for any of these chemicals have never been found on furniture products that we've shipped to our customers. Additionally, this warning label is very common and can be found on almost every piece of furniture sold in the state of California.

Just How Common Are Proposition 65 Warnings?

Proposition 65 warnings have become so common in California that it is hard to take a trip to a local bank, grocery store, or restaurant without finding at least one warning. In fact, even the Disney Land Resort has a Proposition 65 warning:

