

# Assembly Instructions

Caution : You must read this before you proceed

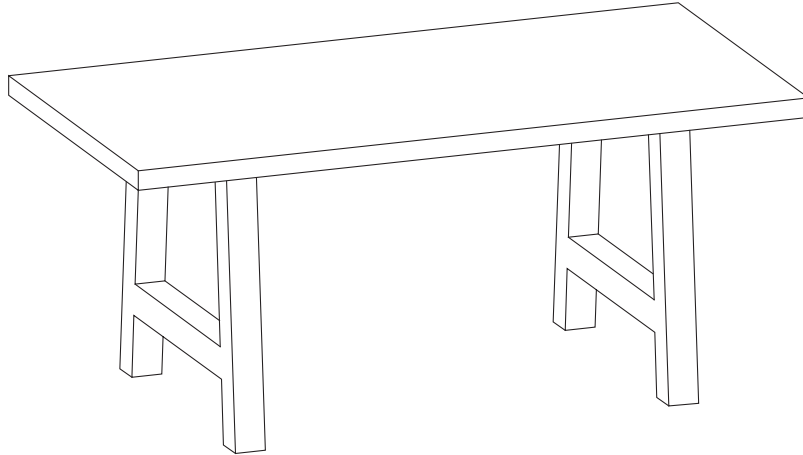



## Table

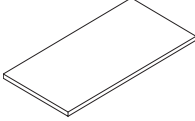
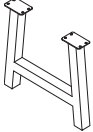

### Part List

Label	Picture	Description	QTY
A		Table Top	1
B		Table Legs	2

### Hardware

Label	Picture	Description	QTY
①		Screw (M8*25)	17
②		Spring washer	17
③		Flat Washer	17
④		Allen key	1

## Assembly Preparation

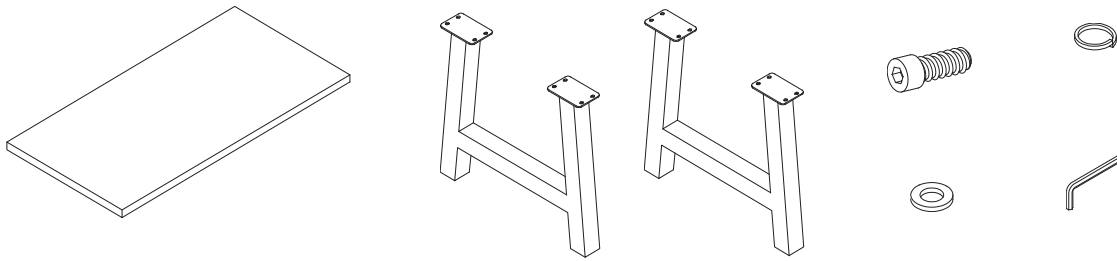

Before Beginning Assembly:

\*Before beginning assembly of product, make sure all parts are present. Compare parts with package contents list. If any parts is missing or damaged, do not attempt to assemble the product.



- Read instructions, cover to cover-



- Have 2 adults on hand for assembly-



- Do not assemble on flooring or carpet-



- Assemble on a clean non-marring surface (packing foam)-



- Save all packaging until finished-

## Assembly Steps

### OVERVIEW

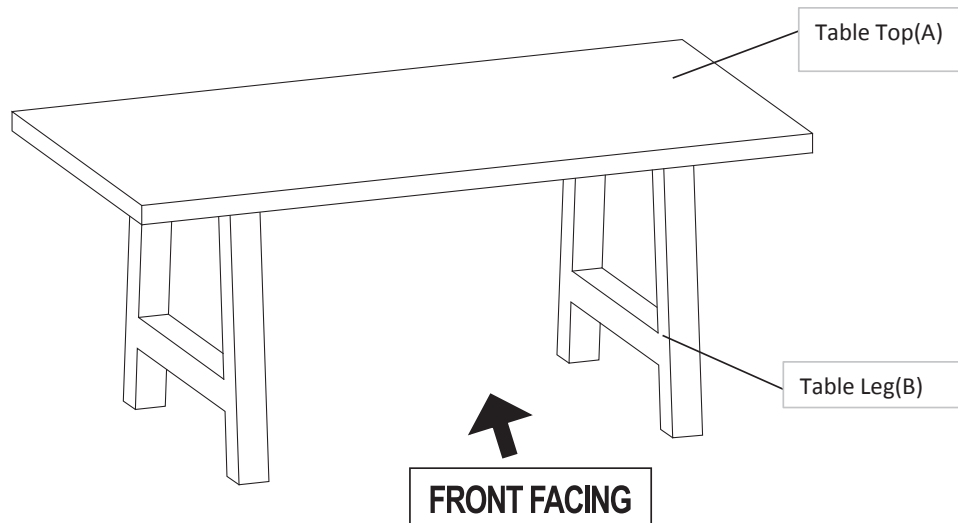

This Table has multiple parts and may require up to 30 minutes to assemble. To give you an overview of the Table parts, the above picture is to help you put the various Table parts into perspective. Please read through the instructions below to familiarise yourself with the parts and steps before assembly.

## Step 1

### Hardware Used

①: M8 Screw



②: Spring Washer



③: Flat Washer



④: Allen key



This side is toward outside.

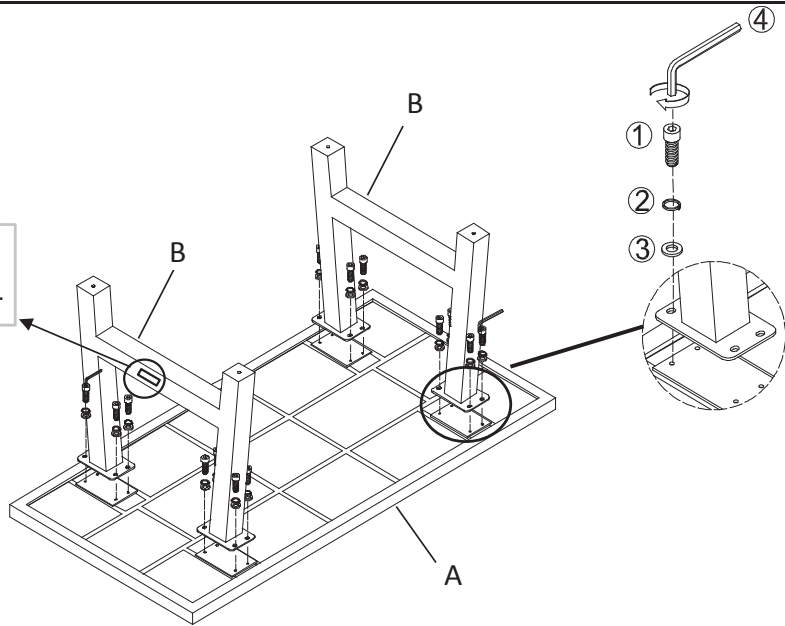

Position the bottom of the Table top(A) as shown.

And then insert the Legs(B) into the mounting position of Table Top(A).

Attach the Legs(B) by using M8 Screw(1) + Spring Washer(2)+ Flat Washer (3), onto metal plate of Legs(B), with Allen Key(4).

Do not over tighten Screws(1) while assembling the Legs(B) in order to adjust the Legs(B) as needed while assembling and make sure you follow the steps fully.

## Step 2

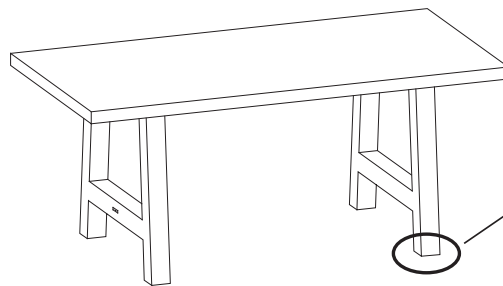

Adjust height  
for balance



Adjust low  
for balance

Adjust Pre-installed  
Levellers  
height for balance

Stand the Table up.

If the Table wobbles, adjust the Pre-installed Levellers at the bottom of the Legs until the Table is level.





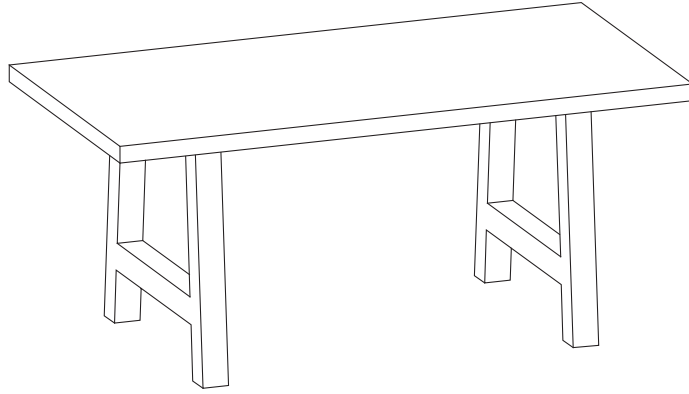













This Table can only be used on a flat, level surface.

**Step 3**



Make sure all parts are connected and securely locked into position.  
Your Table is ready for use.

## Care & Maintenance

-   ● Do not put hot items directly on furniture surface
  -   ● Do not clean furniture with harsh cleansers or polish.
  -   ● To obtain the longest lifespan of your outdoor products, minimizing exposure to direct sunlight is recommended.
  -   ● Children should not climb or jump on the furniture.
  -   ● Do not write on furniture without a padded barrier to protect the surface.
  -   ● To obtain the longest lifespan of your outdoor products, avoid extended and lengthy exposure to rain, snow, and direct sunshine. Whenever possible cover the product and /or place under patio or awnings.
  -   ● Not for commercial use. For residential use only .
  -   ● Stains may be removed with mild soap solution and damp cloth.
- 
-   ● Dust and pick-up spills using a clean, non-colored, lint-free cloth .