

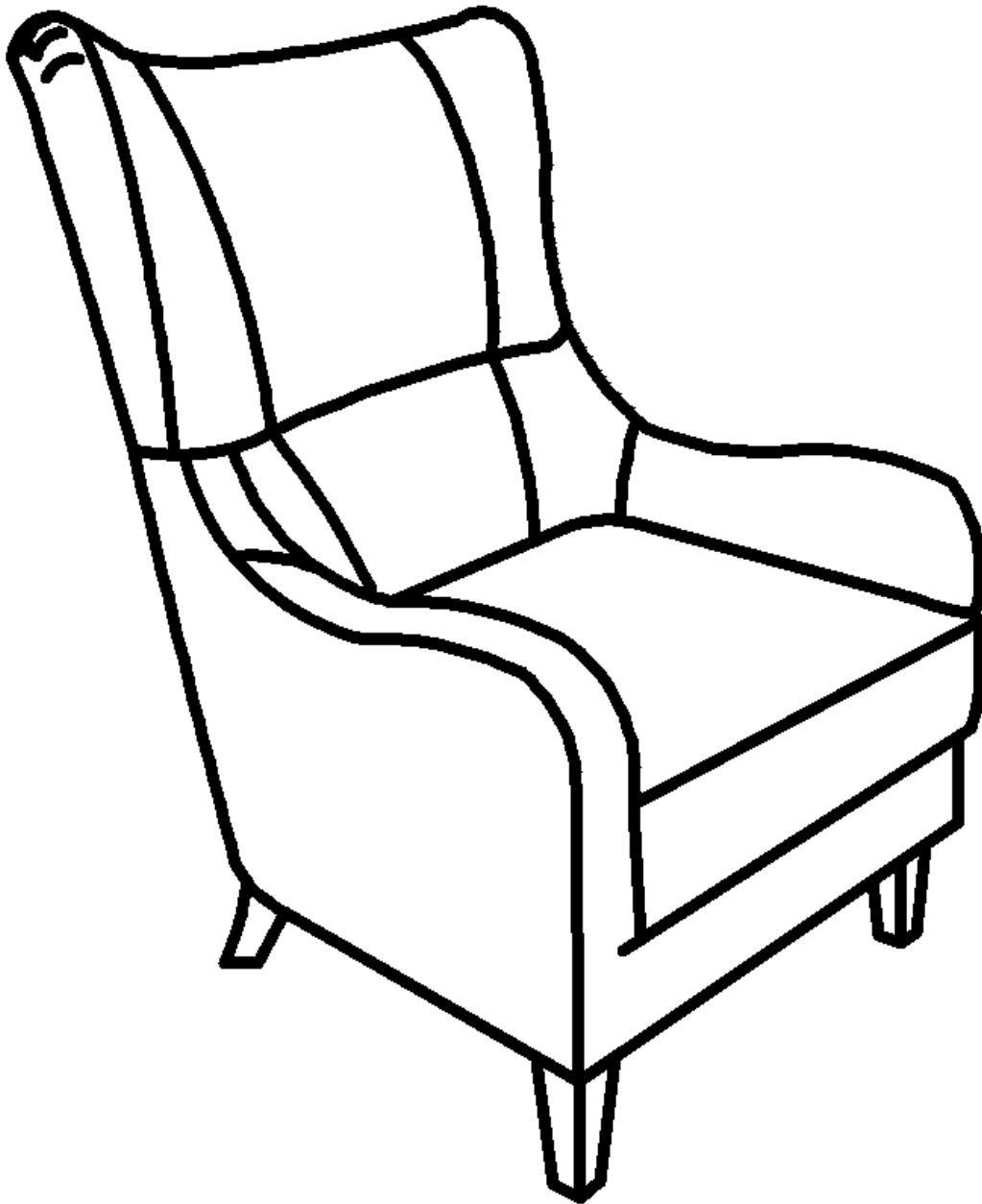

Assembly Instructions

Club Chair

Caution: You must read this before you proceed.

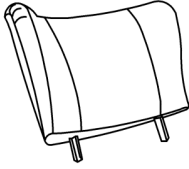
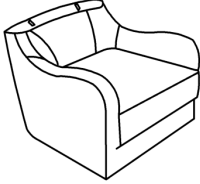

Parts List

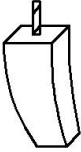
Part NO.	Picture	Description	QTY
A		Chair Backrest	1
B		Chair Seat	1
C		Front Wooden Leg	2
D		Back Wooden Leg	2





Hardware

Label	Picture	Description	QTY
1		Gasket	7

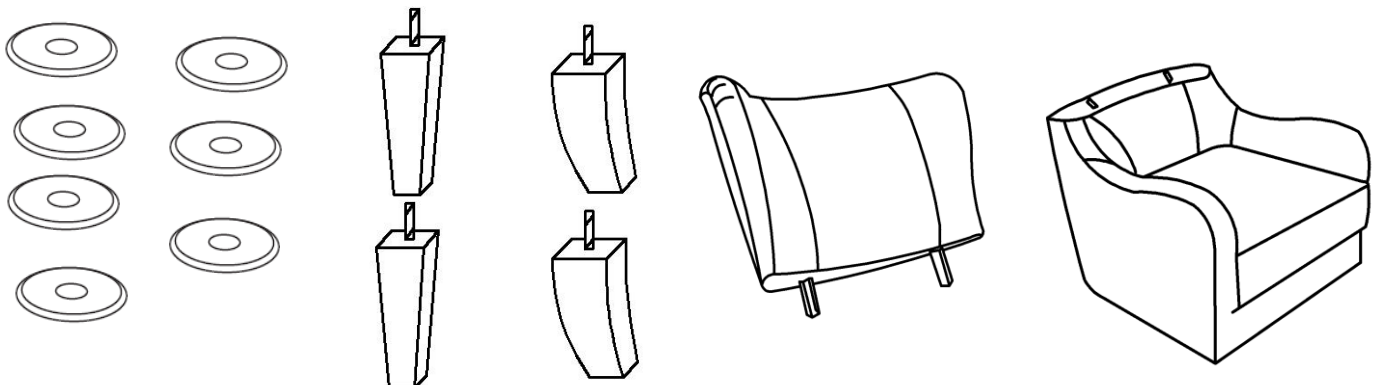
Assembly Preparation

Before Beginning Assembly:



-  • Read instructions, cover to cover-
-  • Have 2 adults on hand for assembly-
-  • Do not assemble on flooring or carpet-
-  • Assemble on a clean non-marring surface (packing foam)-
-  • Save all packaging until finished-

Assembly Steps

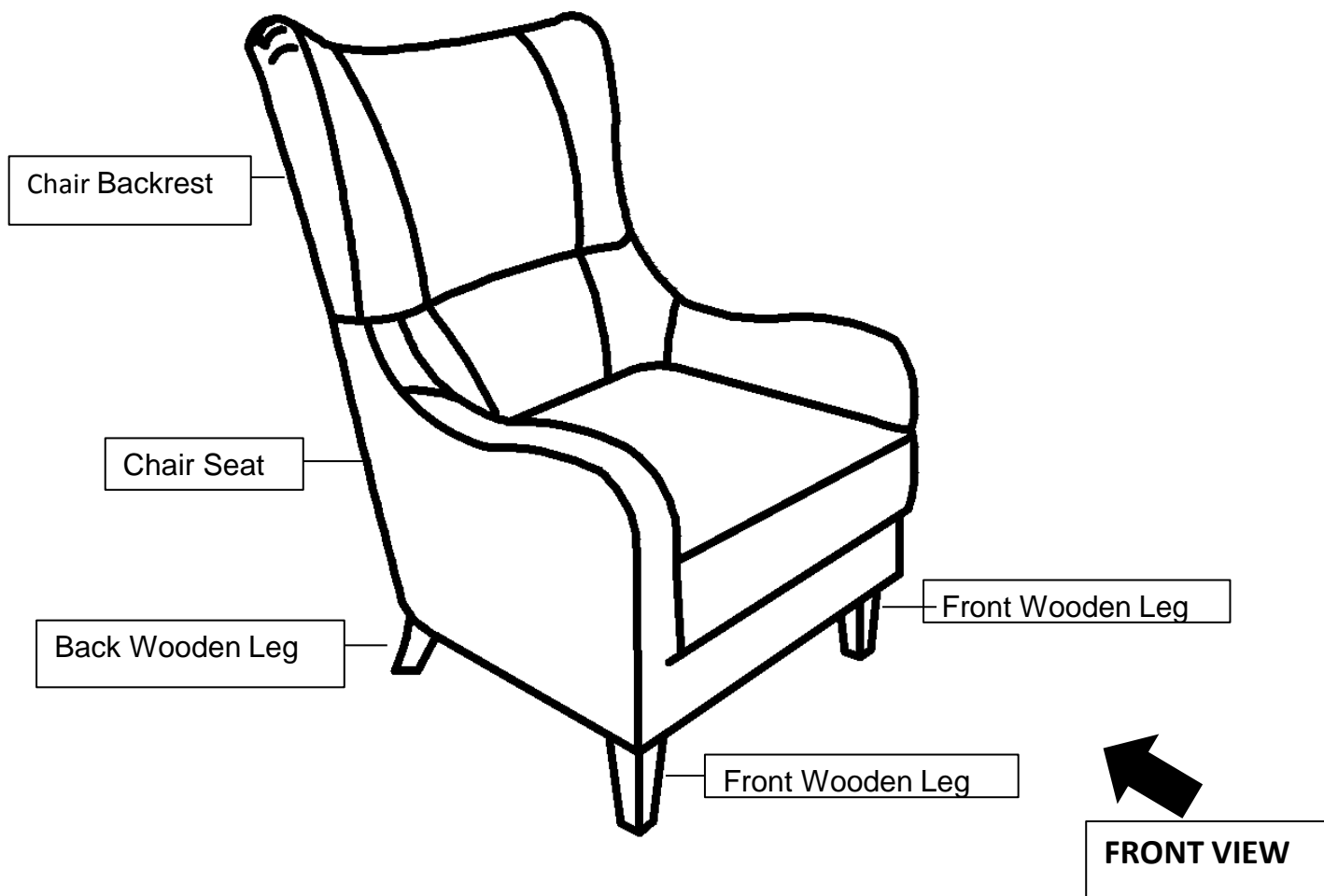

Step 1

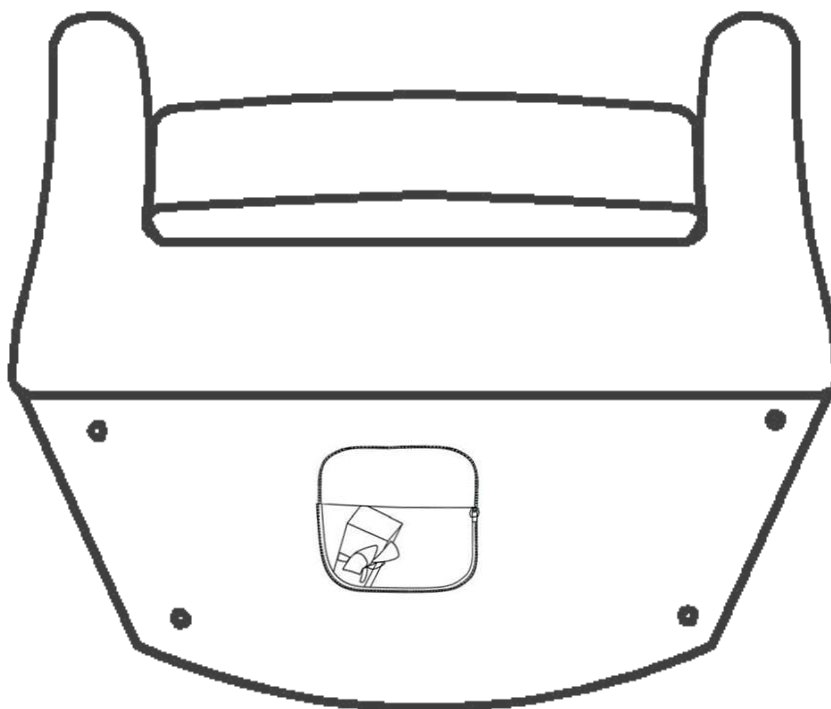

Position Chair Seat on its back, as shown, on a clean, non-marring surface. Unzip to open and remove the 4 Wooden Legs. Close pouch before assembling.

Step 2

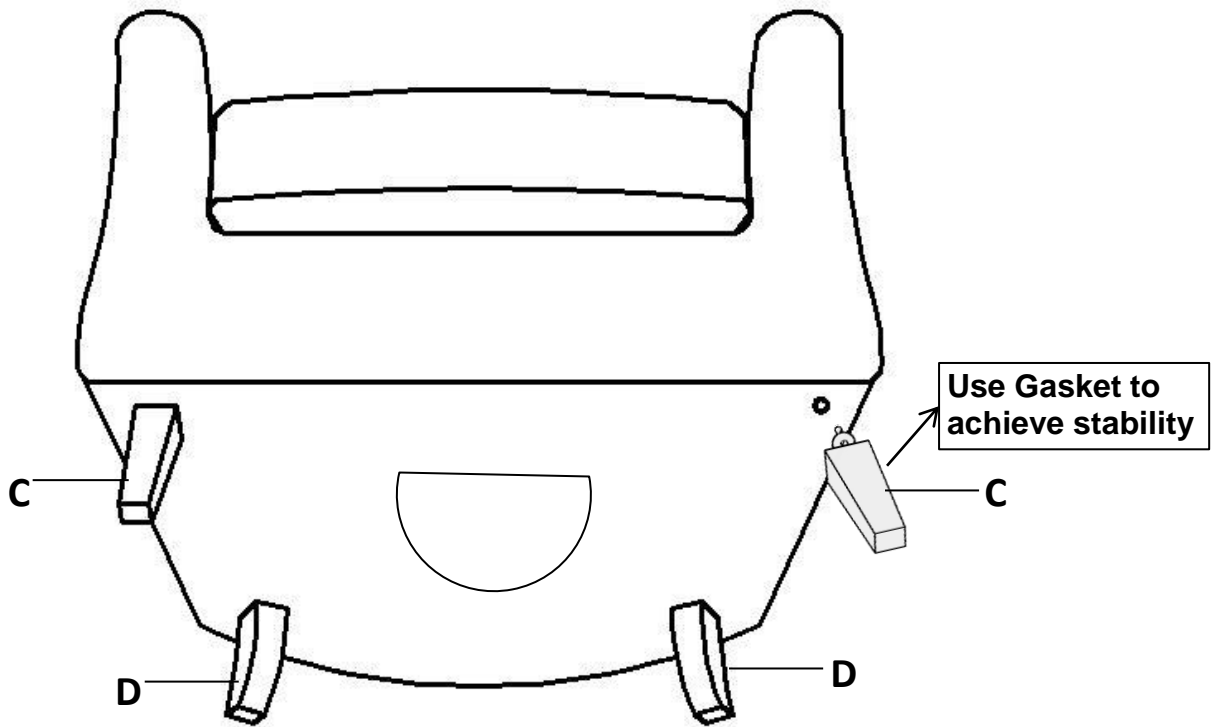

Install the Front Wooden Leg(C) at the bottom of the Sofa by placing one Gasket(1) on the threaded stem.

Then insert the threaded stem into the threaded mounting position at the corner of the Chair.

Tighten by turning the Leg clockwise.

Repeat the same process to install the remaining three Legs.

Note : The use of Gaskets are OPTIONAL and are especially useful to help alleviate slight wobbles.

Some Legs may need more than one whilst some legs may not need any.

Position Chair right side up and test for levelness.

Add or remove Gaskets where needed to achieve levelness.

Step 3

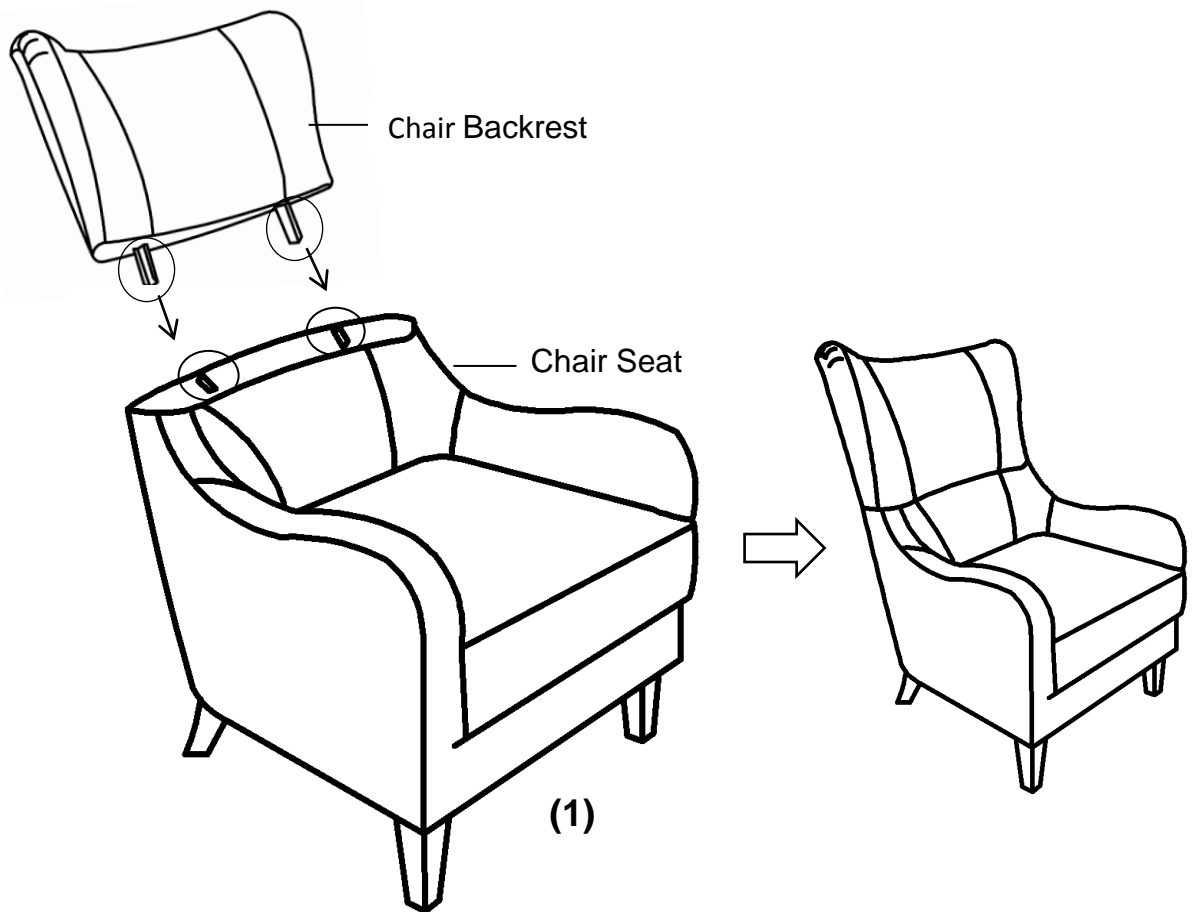

Place the Chair upright.





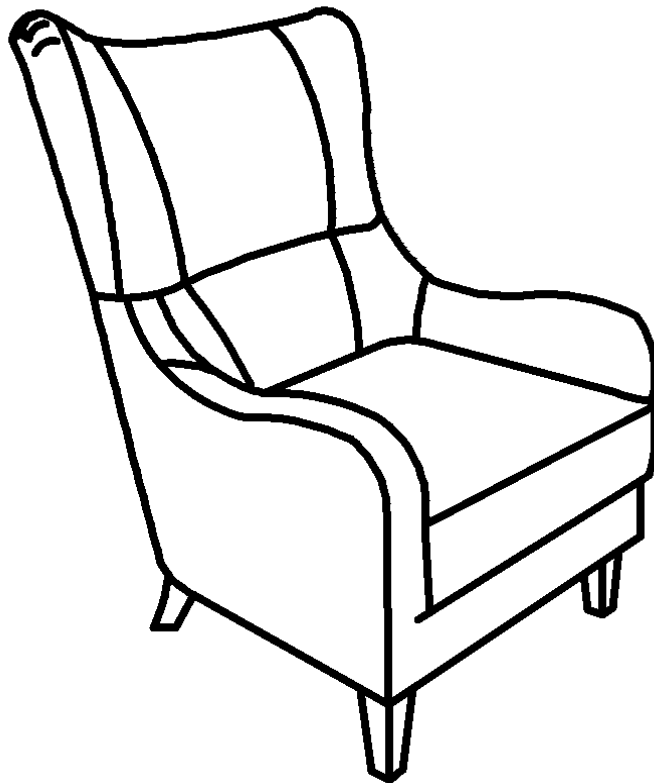





Then push the Chair Backrest(A) downwards until the Backrest is fully slotted and locked into position as shown in the picture(1).

Step 4



Make sure all parts are connected and securely locked into position.
Your Chair is ready for use.

Care & Maintenance

-  Do not put hot items directly on furniture surface
 -  Do not clean furniture with harsh cleansers or polish.
 -  Do not place furniture under direct sunlight.
 -  Do not place furniture near heating or cooling vents.
 -  Do not write on furniture without a padded barrier to protect the surface.
 -  Do not place furniture outside . For indoor use only .
 -  Not for commercial use. For residential use only .
 -  Stains may be removed with mild soap solution and damp cloth.
 -  Children should not climb or jump on the furniture.
-
-  Dust and pick-up spills using a clean, non-colored, lint-free cloth .