

WARNING!!

Children have died from furniture tipover. Tip restraints have been included with this product; you must install the tip restraints according to these instructions in order to minimize the risk of furniture tipping. If you have any questions about this product or the tip restraint, please send us an email at tip_restraint_help@Noblehousefurniture.com

NEVER allow children to climb or hang on furniture, including drawers or cabinet doors.

In addition to installing the restrains, to help prevent tip-over

1. **NEVER** put a TV or other heavy objects on top of this product".
2. Do not stand on the product

⚠ WARNING	
	<p>Children have died from furniture tipover. To reduce the risk of furniture tipover:</p> <ul style="list-style-type: none">• ALWAYS install tipover restraint provided.• NEVER put a TV on this product.• NEVER allow children to stand, climb or hang on drawers, doors, or shelves.• NEVER open more than one drawer at a time.• Place heaviest items in the lowest drawers.• Do not defeat or remove the drawer interlock system. <p><i>This is a permanent label. Do not remove!</i></p>
	

Assembly Instructions













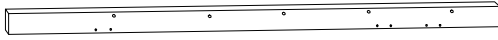
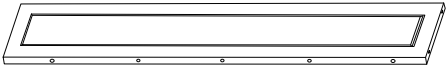
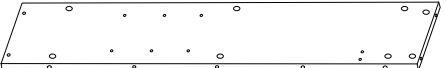

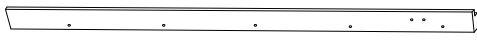
Caution : You must read this before you proceed

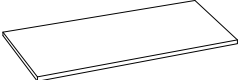
Please look in the velcro pouch for hardware packs and legs.

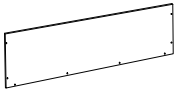

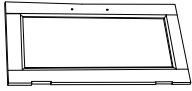
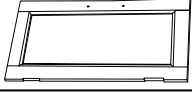
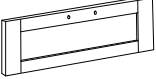



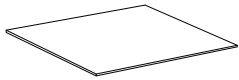







Cabinet





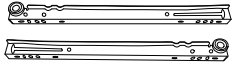

Parts List

Label	Picture	Description	QTY
A		Top Panel	1
B		Left Front Leg	1
C		Right Front Leg	1
D		Left Side Panel	1
E		Right Side Panel	1
F		Left Back Leg	1
G		Right Back Leg	1
H		Drawer Slide Bar	2
I		Adjustable Panel	1
J		Bottom Panel	1
K		Back Panel	2
L		Connect Bar	1
M		Back Slat	1
N		Left Door Panel	1
O		Right Door Panel	1
P		Drawer Front Panel	1
Q		Drawer Left Panel	1
R		Drawer Right Panel	1
S		Drawer Back Panel	1
T		Drawer Bottom Panel	1

Hardware

Label	Picture	Description	QTY
①		Cam Bolt	27
②		Cam Nut	27
③		Dowel	19
④		Screw (M3x12mm)	27
⑤		Hinge	4
⑥		Handle Bolt (M4x16mm)	7
⑦		Handle	3
⑧		Magnetic Bar	2
⑨		Magnet	1
⑩		Screw (M4x30mm)	5
⑪		Self Pin	4
⑫		Screw (M2x10mm)	17
⑬		Slide for Side Panel	1
⑭		Slide for Drawer Panel	1
⑮		Screw (M3x14mm)	3

Restraint Device Hardware

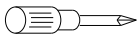
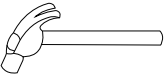
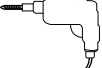
⑯		Screw (M3x12mm)	2
⑰		Restraint Strap	2
⑱		Metal Gasket	4
⑲		Wall Anchor Screw	2
⑳		Screw (M4x35mm)	2
㉑		Screwdriver (Not provided)	1
㉒		Hammer (Not provided)	1
㉓		Power Drill (Not provided)	1

Assembly Preparation

Before Beginning Assembly:

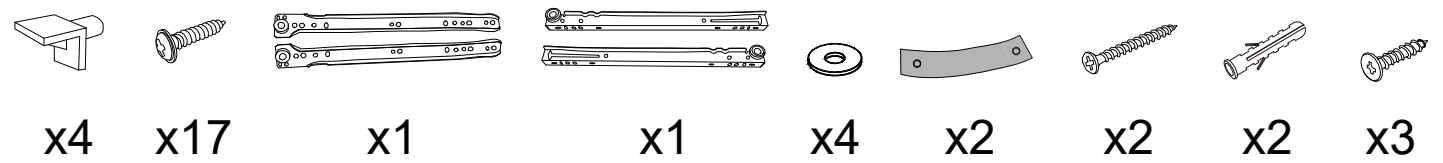
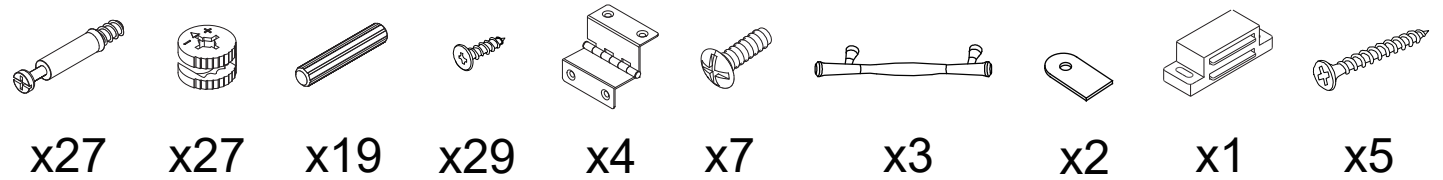
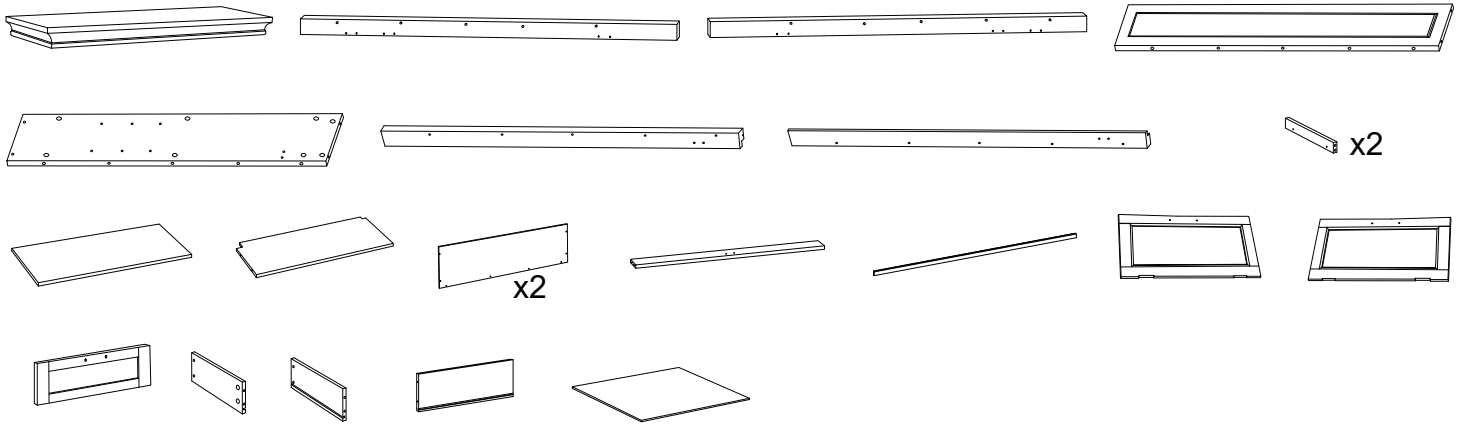

- Read instructions, cover to cover-



- Have 2 adults on hand for assembly-



- Do not assemble on flooring or carpet-



- Assemble on a clean non-marring surface (packing foam)-



- Save all packaging until finished-

Assembly Steps

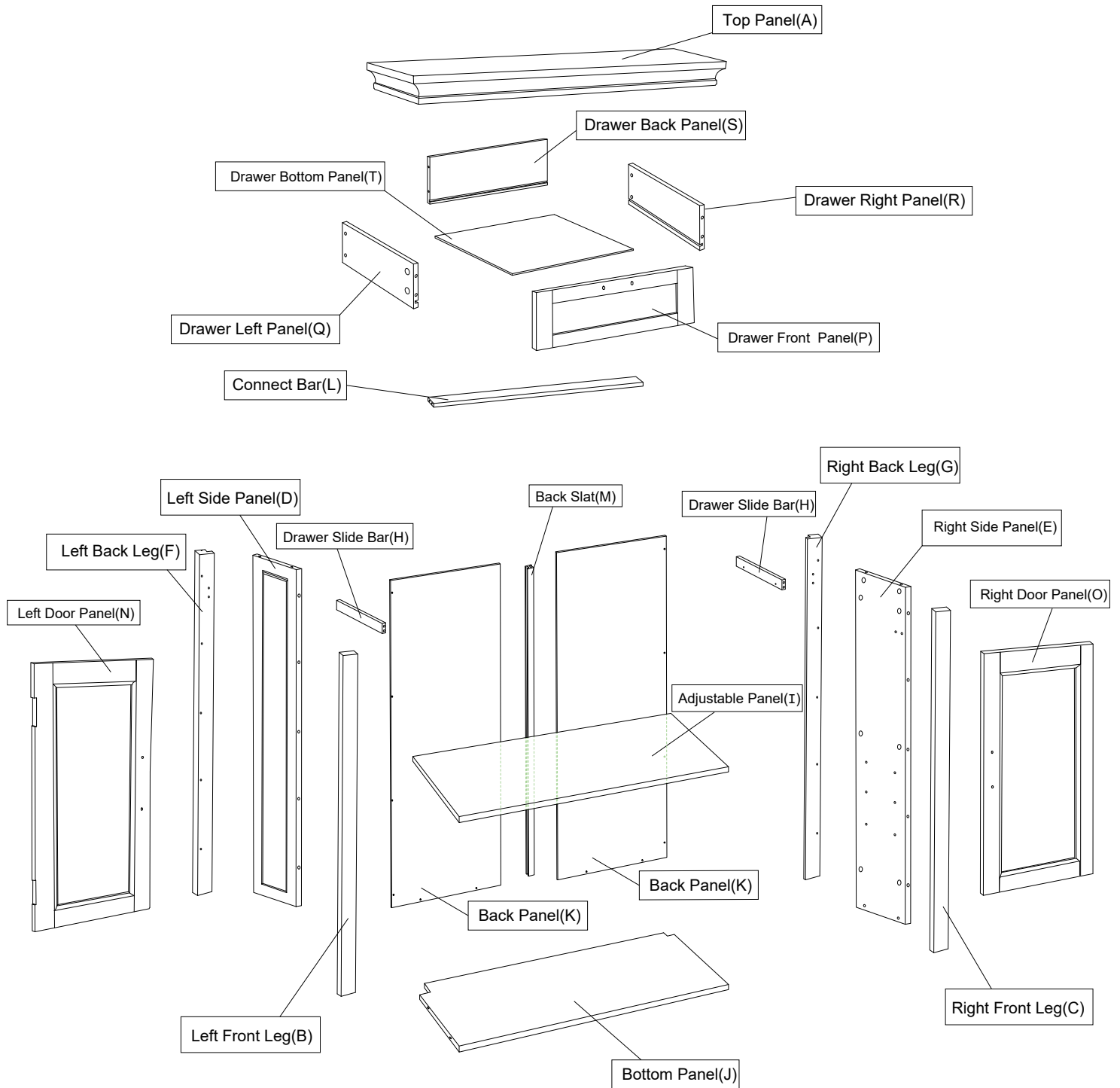

This Cabinet has multiple parts and may require up to 60 minutes to assemble.

To give you an overview of the Cabinet parts, the above picture is to help you put the various parts into perspective.

Please read through the instructions below to familiarise yourself with the parts and steps before assembly.

Step 1

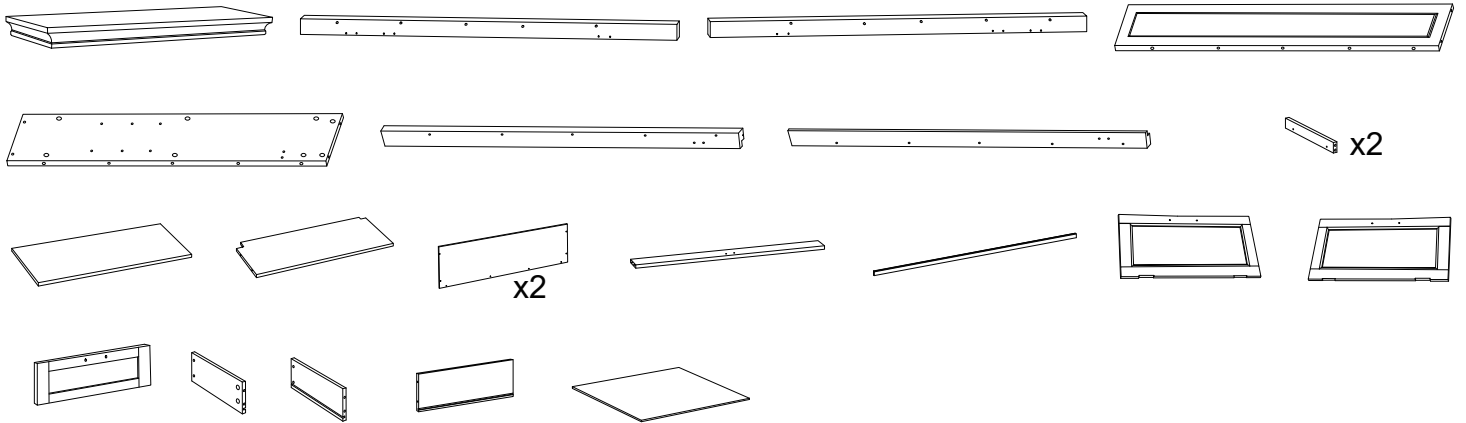

Unpack and place all parts on a clean, non-marring surface.

Step 2

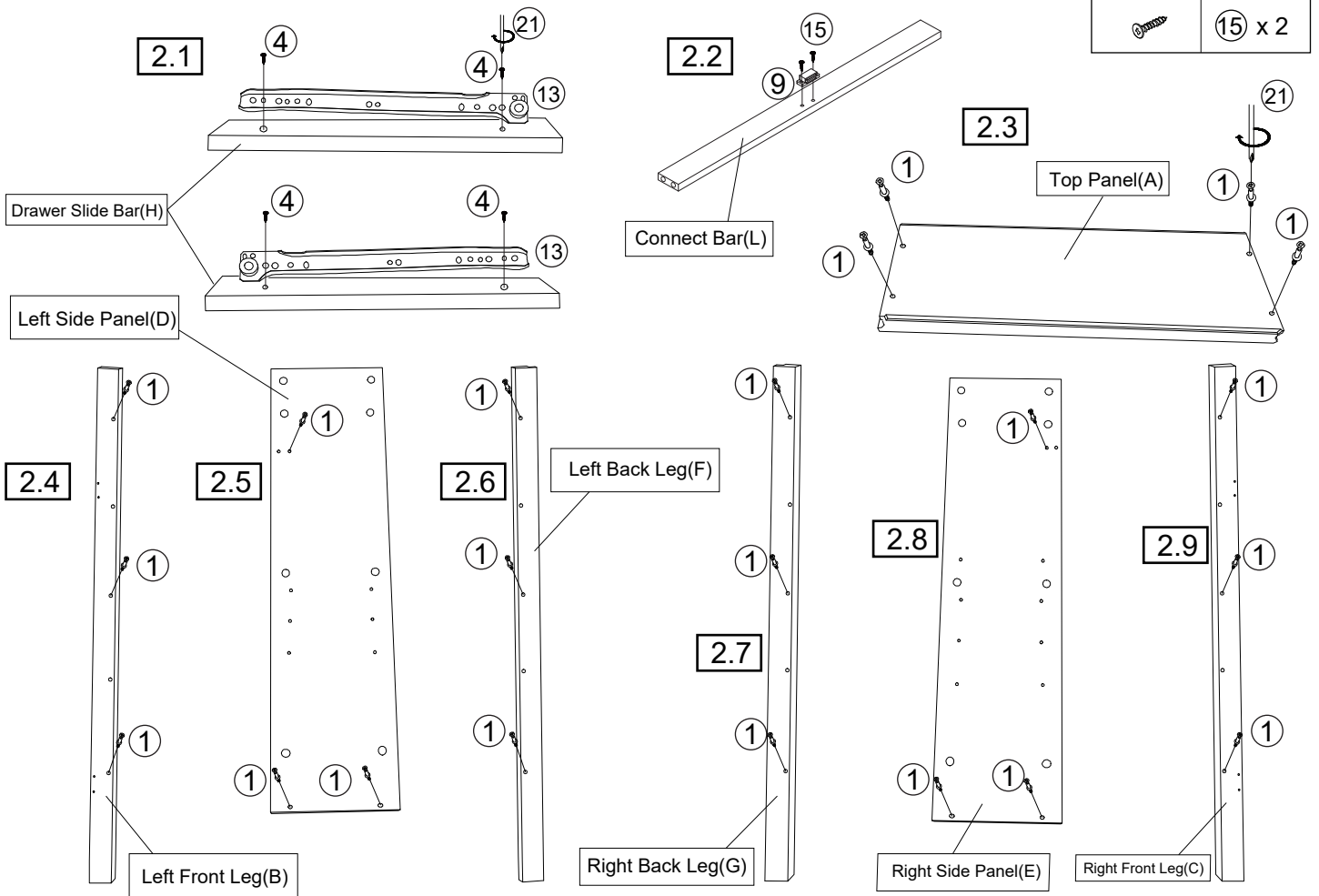
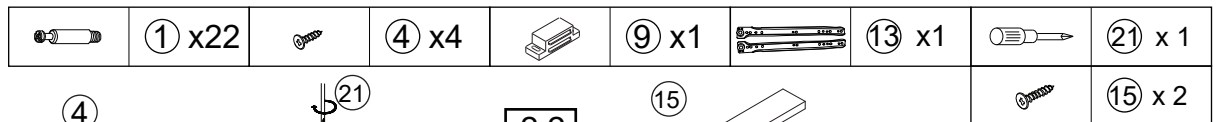

- 2.1) Attach Slide (⑬) to the Drawer Slide Bar (H) with Screw (④) using Screwdriver (㉑).
- 2.2) Attach Hinge Magnetic (⑨) to Connect Bar (L) with Screw (⑮) using Screwdriver(㉑).
- 2.3) Insert Cam Bolt (①) into the mounting positions on Top Panel (A) using Screwdriver(㉑).
- 2.4) Insert Cam Bolt (①) into the mounting positions on Left Front Leg(B) using Screwdriver(㉑).
- 2.5) Insert Cam Bolt (①) into the mounting positions on Left Side Panel(D) using Screwdriver(㉑).
- 2.6) Insert Cam Bolt (①) into the mounting positions on Left Back Leg(F) using Screwdriver(㉑).
- 2.7),2.8),2.9) Repeat the same step with Right Back Leg(G),Right Side Panel(E) and Right Front Leg (C).

Step 3

	② x12		③ x16
--	-------	--	-------

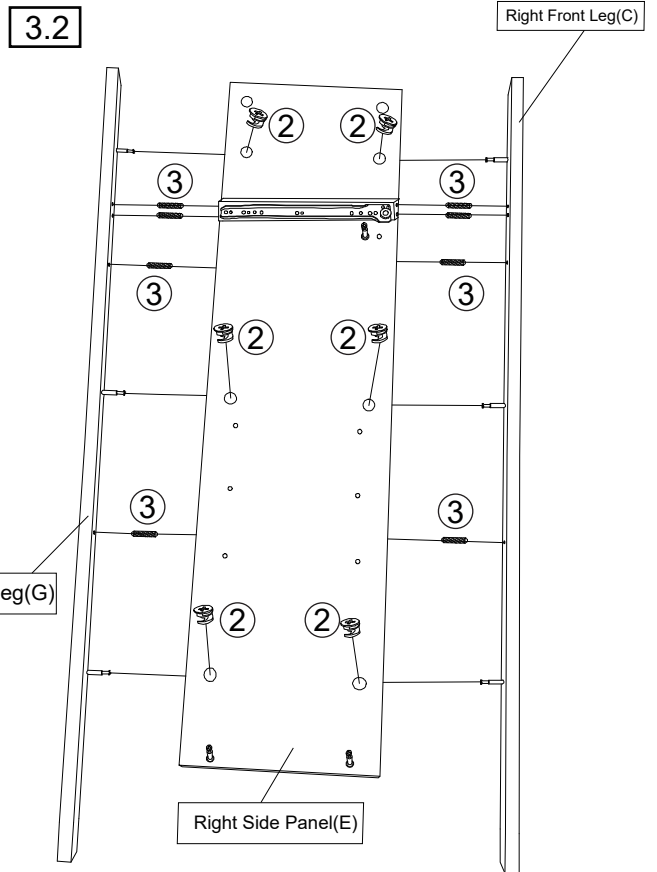
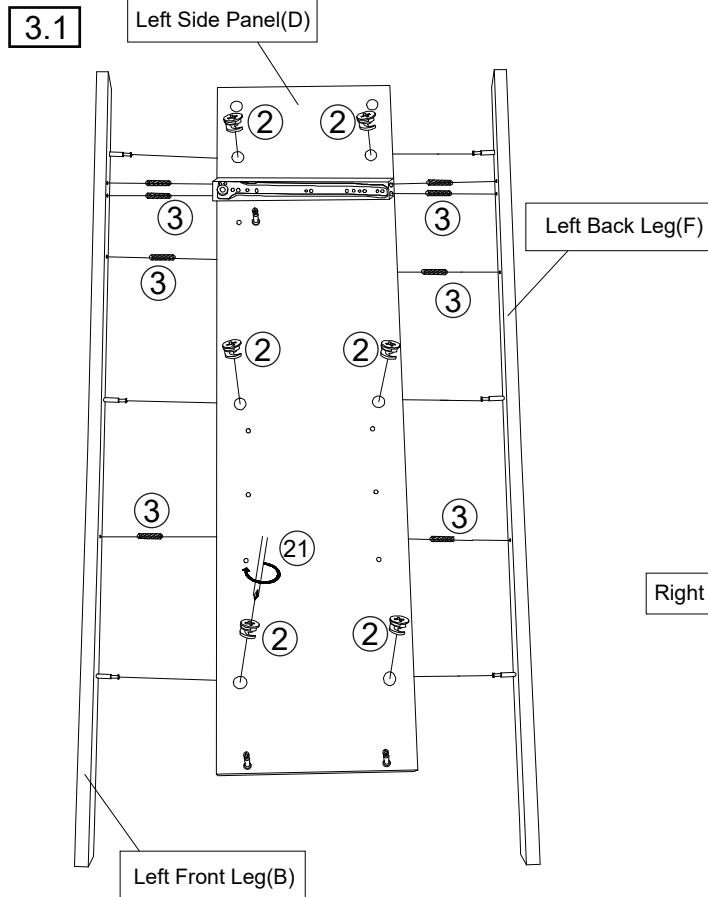

3.1) Attach Left Front Leg(B) and Left Back Leg(F) to Left Side Panel(D) with Dowel (③), then insert Cam Nut (②) into Left Side Panel(D) using Screwdriver(⑳) turning clockwise until tight.

3.2) Repeat the same step with Right Back Leg(G), Right Side Panel(E) and Right Front Leg (C).

Step 4

	② x 6
	③ x 2

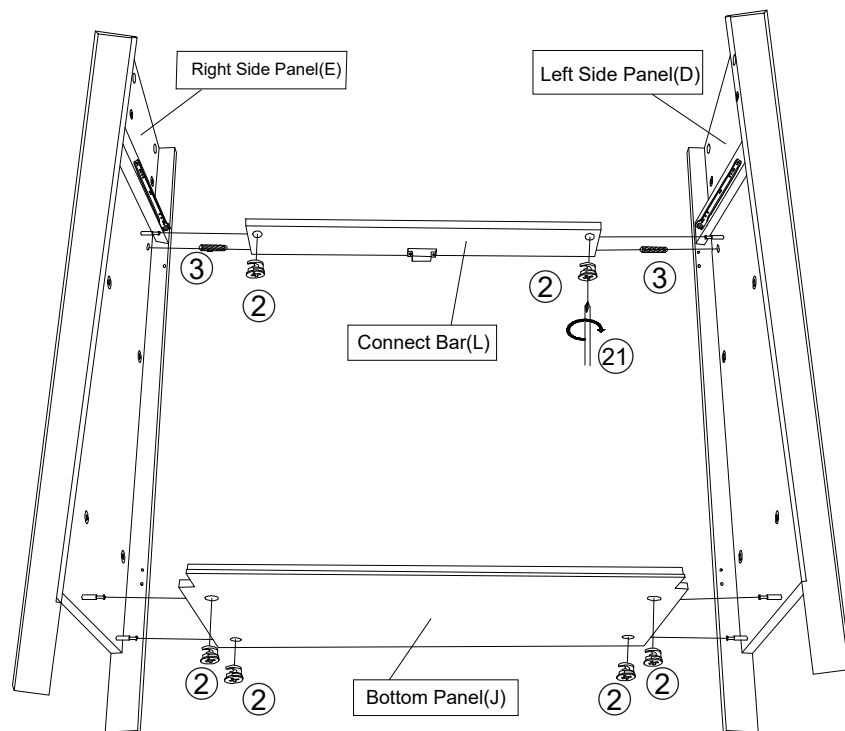

Attach Right Side Panel (E) and Left Side Panel (D) to Connect Bar (L) and Bottom Panel (J) with Dowel (③), then insert Cam Nut (②) into Connect Bar (L) and Bottom Panel (J) using Screwdriver(⑳) turning clockwise until tight.

Step 5

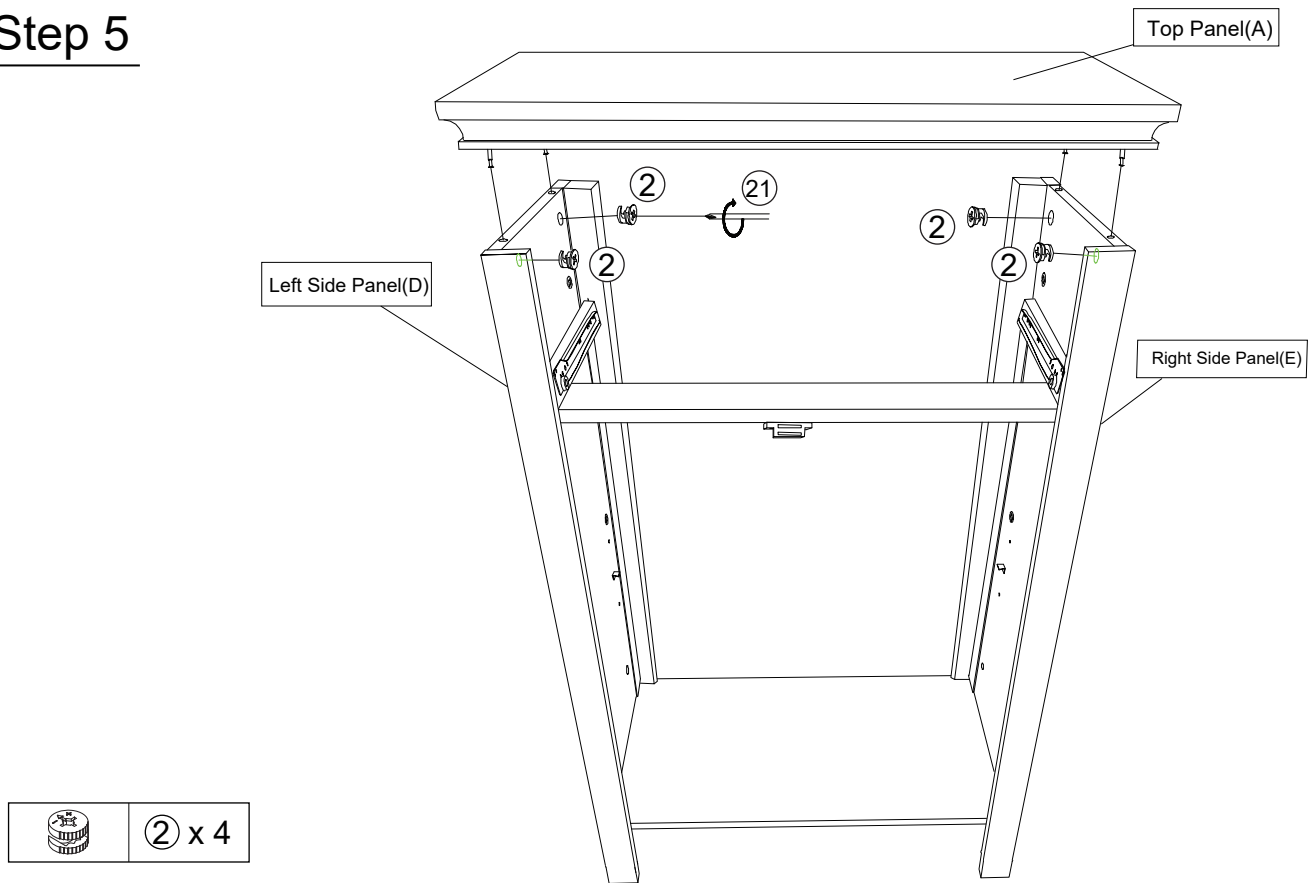

Attach Top Panel (A) to Left Side Panel (D) and Right Side Panel (E), then insert Cam Nut (2) into Left Side Panel (D) and Right Side Panel (E) using Screwdriver (21) turning clockwise until tight.

Step 6

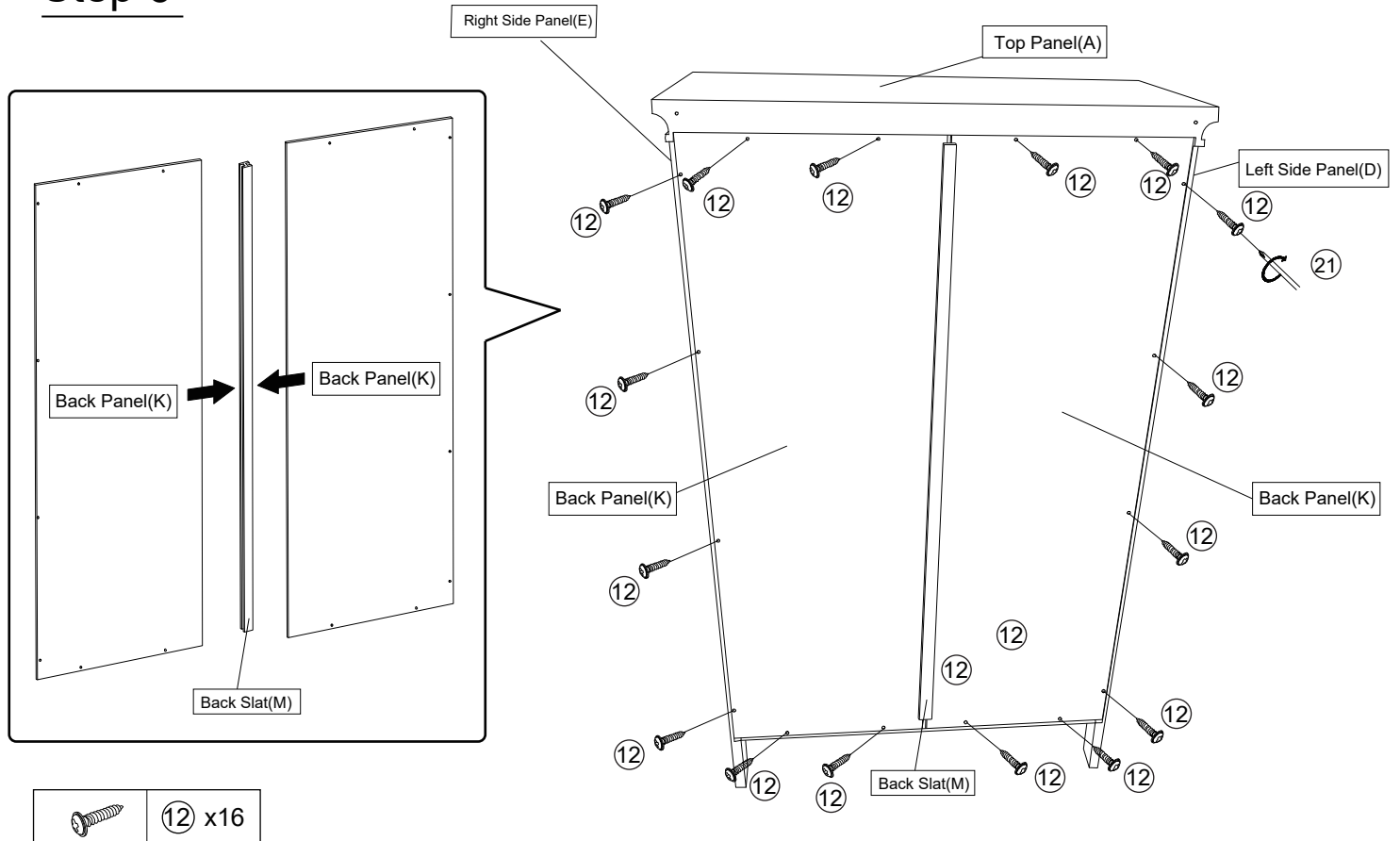

Insert Back Panel (K) into groove of Back Slat (M), then attach the whole Back Panel to Left Side Panel (D) , Right Side Panel (E) and Top Panel (A) with Screw (12) using Screwdriver (21).

Step 7

7.1

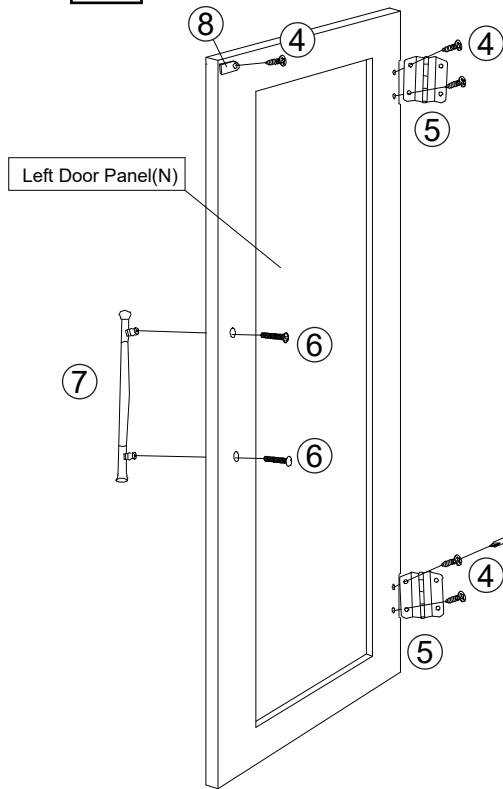

7.2

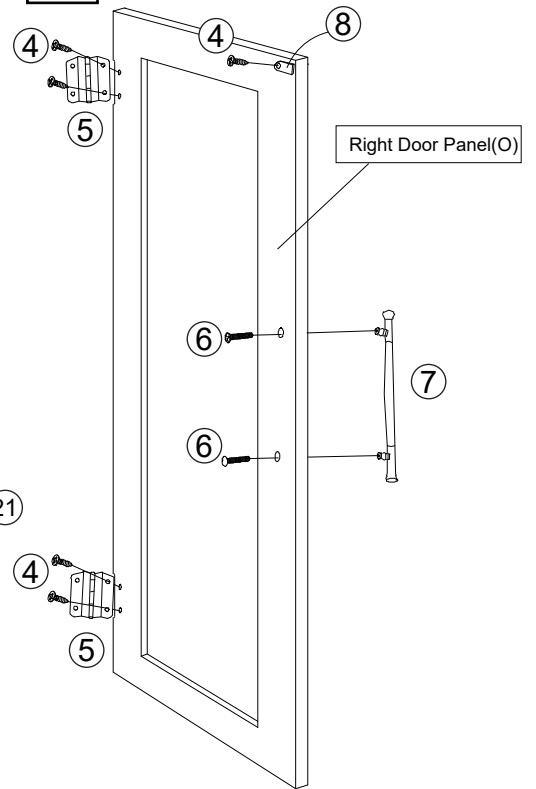

	④ x 10
	⑤ x 4
	⑥ x 4
	⑦ x 2
	⑧ x 2

7.1) Attach Hinge (⑤) and Magnetic Bar (⑧) to Left Door Panel (N) with Screw (④) using Screwdriver (⑳). Attach Handle (⑦) to Left Door Panel (N) with Handle Bolt (⑥) using Screwdriver (⑳).
7.2) Repeat the same step with Right Door Panel (O).

Step 8

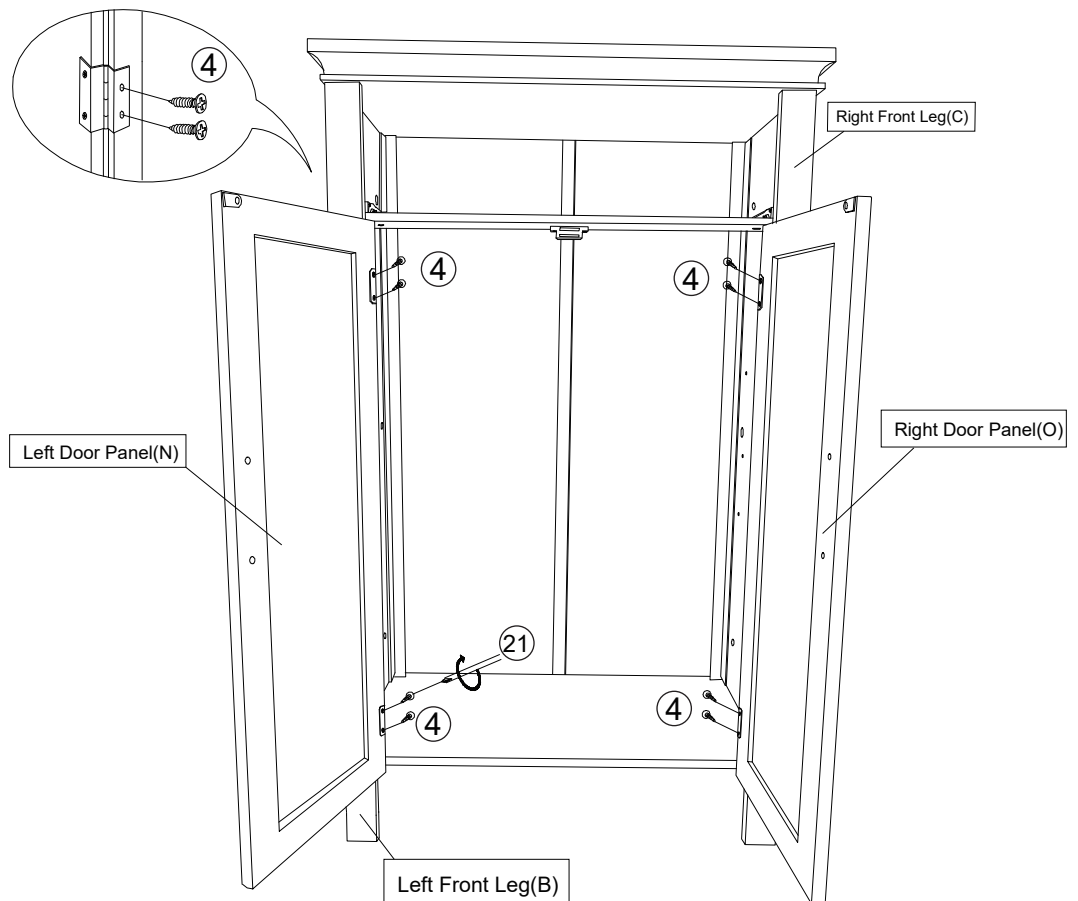

	④ x 8
--	-------

Attach Left Door Panel (N) to Left Front Leg (B) by attaching the other side of Hinge (⑤) to Left Front Leg (B) with Screw (④) using Screwdriver (⑳). Repeat the same step with and Right Door Panel (O).

Step 9

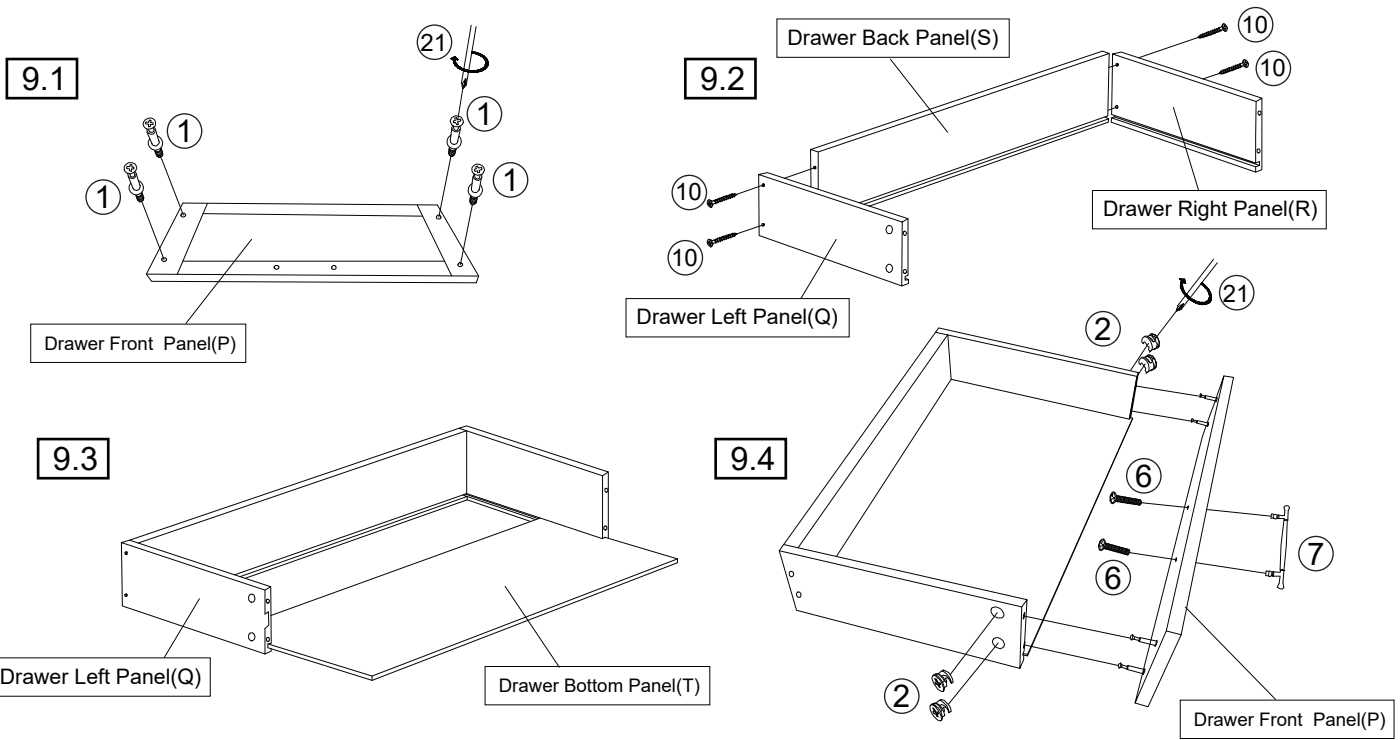

- 9.1) Insert Cam Bolt (①) into the mounting positions on Drawer Front Panel (P) using Screwdriver(②①).
- 9.2) Attach Drawer Left Panel (Q) and Drawer Right (R) to Drawer Back Panel (S) with Screw (⑩) using Screwdriver(②①).
- 9.3) Insert Drawer Bottom Panel (T) into groove of Drawer Left Panel (Q) , Drawer Back Panel (S) and Drawer Right Panel (R) .
- 9.4) Attach Drawer Front Panel (P) to Drawer Left Panel (Q) and Drawer Right Panel (R) , then insert Cam Nut(②) using Screwdriver(②①) turning clockwise until tight. Attach Handle (⑦) to the Drawer Front Panel (P) with Handle Bolt (⑥) using Screwdriver(②①).

Step 10

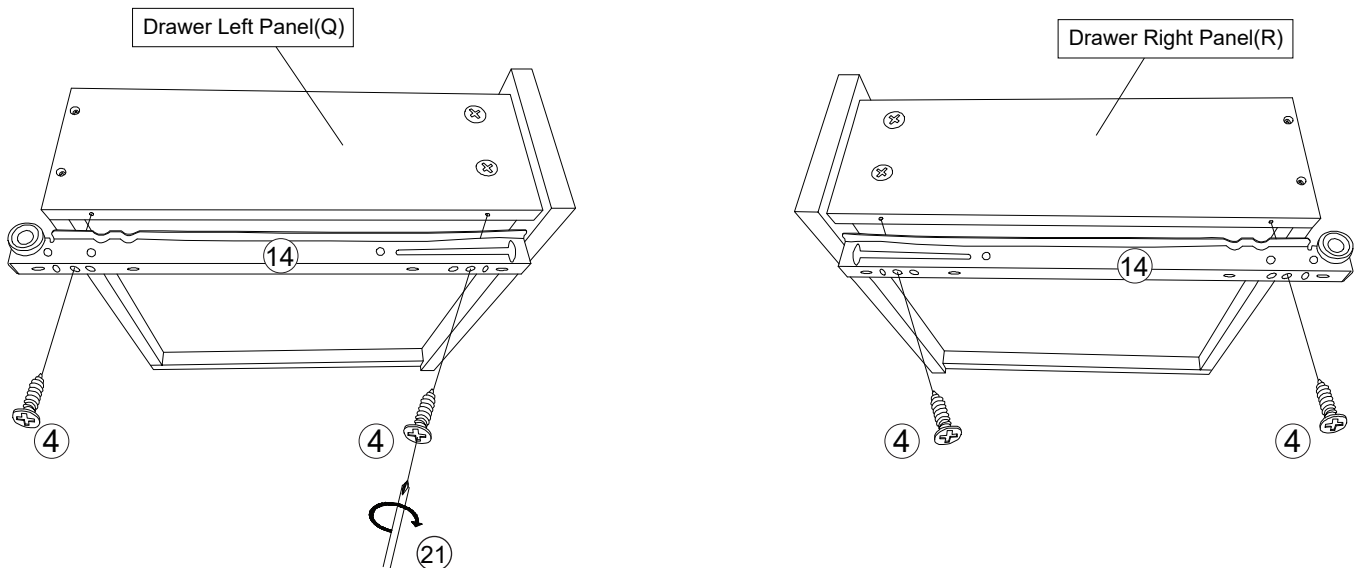

- Attach Slide (⑭) to Drawer Left Panel (Q) with Screw (④) using Screwdriver(②①).
Repeat the same step with Drawer Right Panel (R).

Step 11

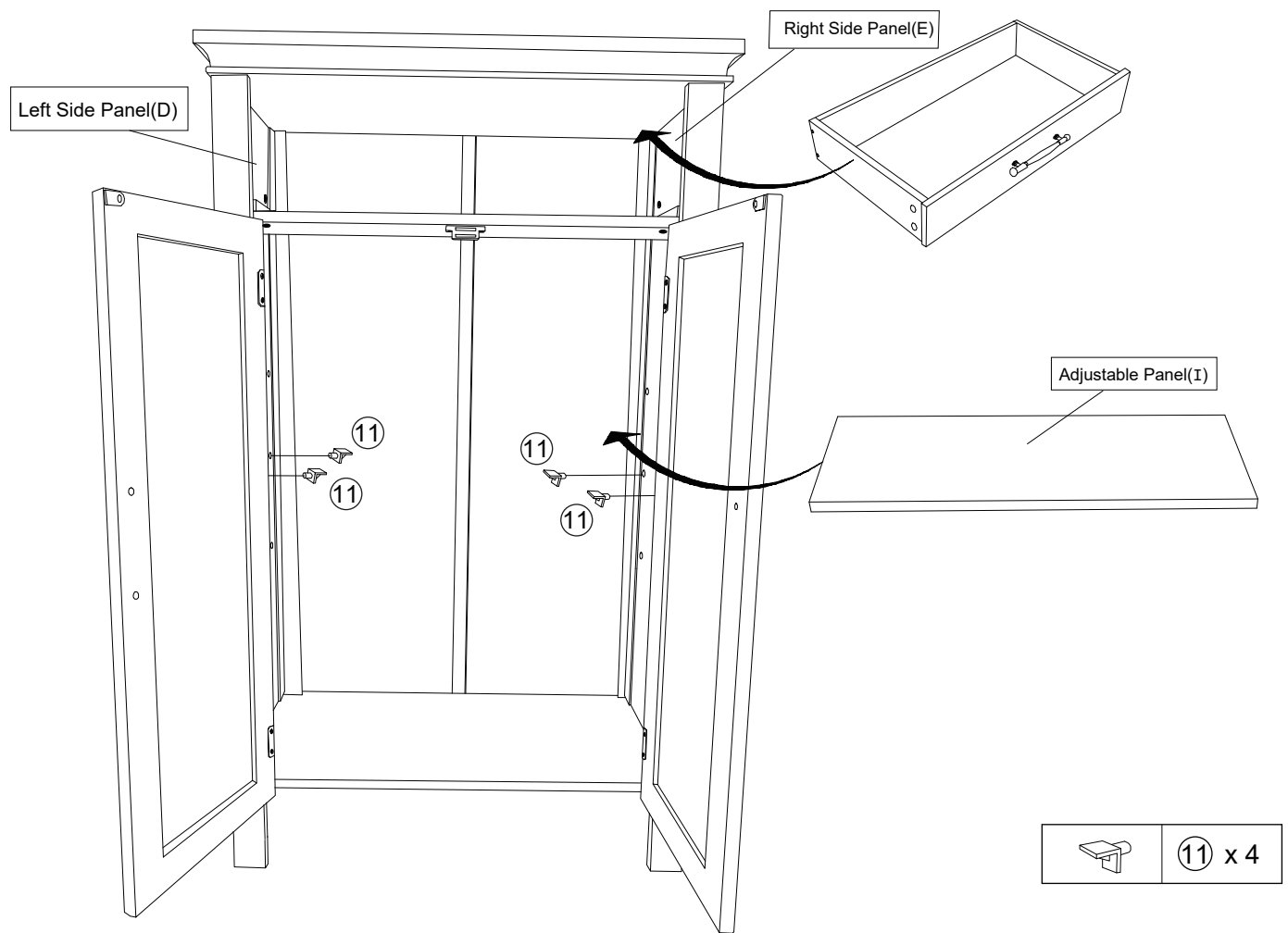

Insert Self Pin (⑪) into Left Side Panel (D) and Right Side Panel(E) . Put the Drawer into the drawer slide, then put the Adustable Panel (I) on the Self Pin (⑪).



WARNING

Serious or fatal crushing injuries can occur from tipping furniture. To help prevent tip-over: ALWAYS secure this furniture to the wall using Cabinet Restraint Device. See product instructions for more ways to help prevent furniture tip-over.



Step 12

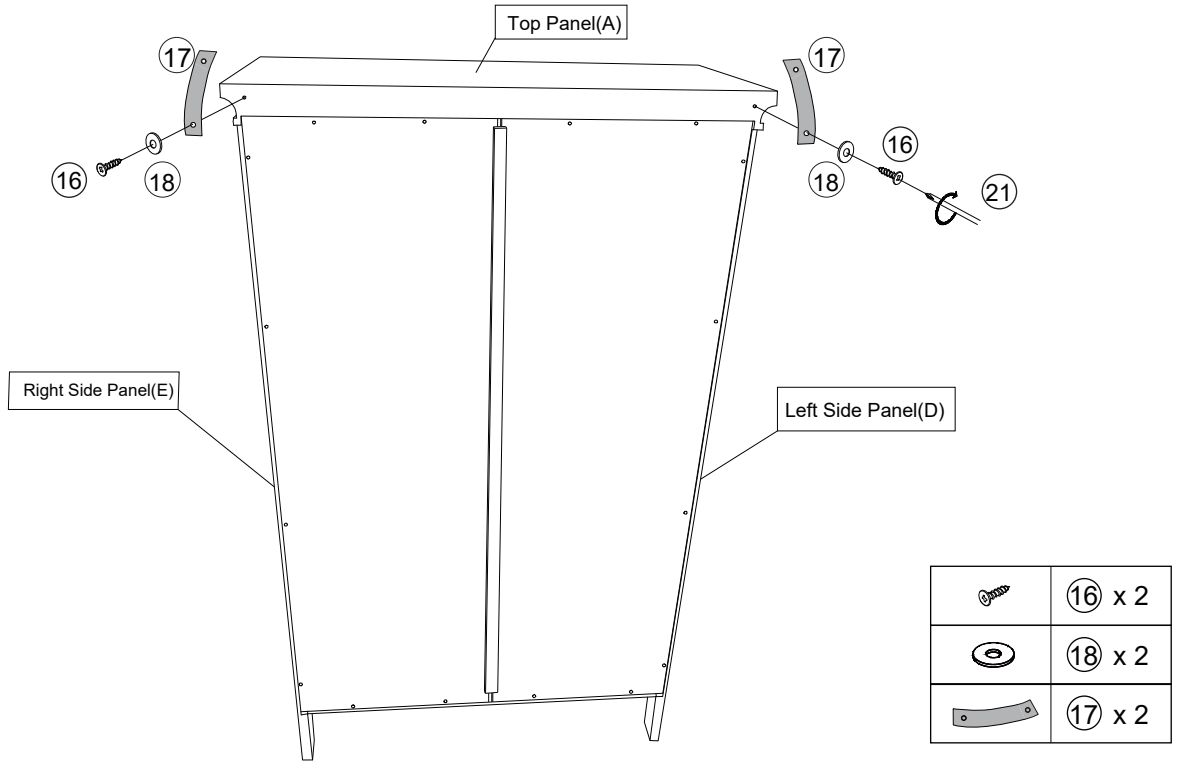

Attach Restraint Strap (17) to the Top Panel (A) with Screw (16) and Metal Gasket (18) using Screwdriver (21).

Step 13

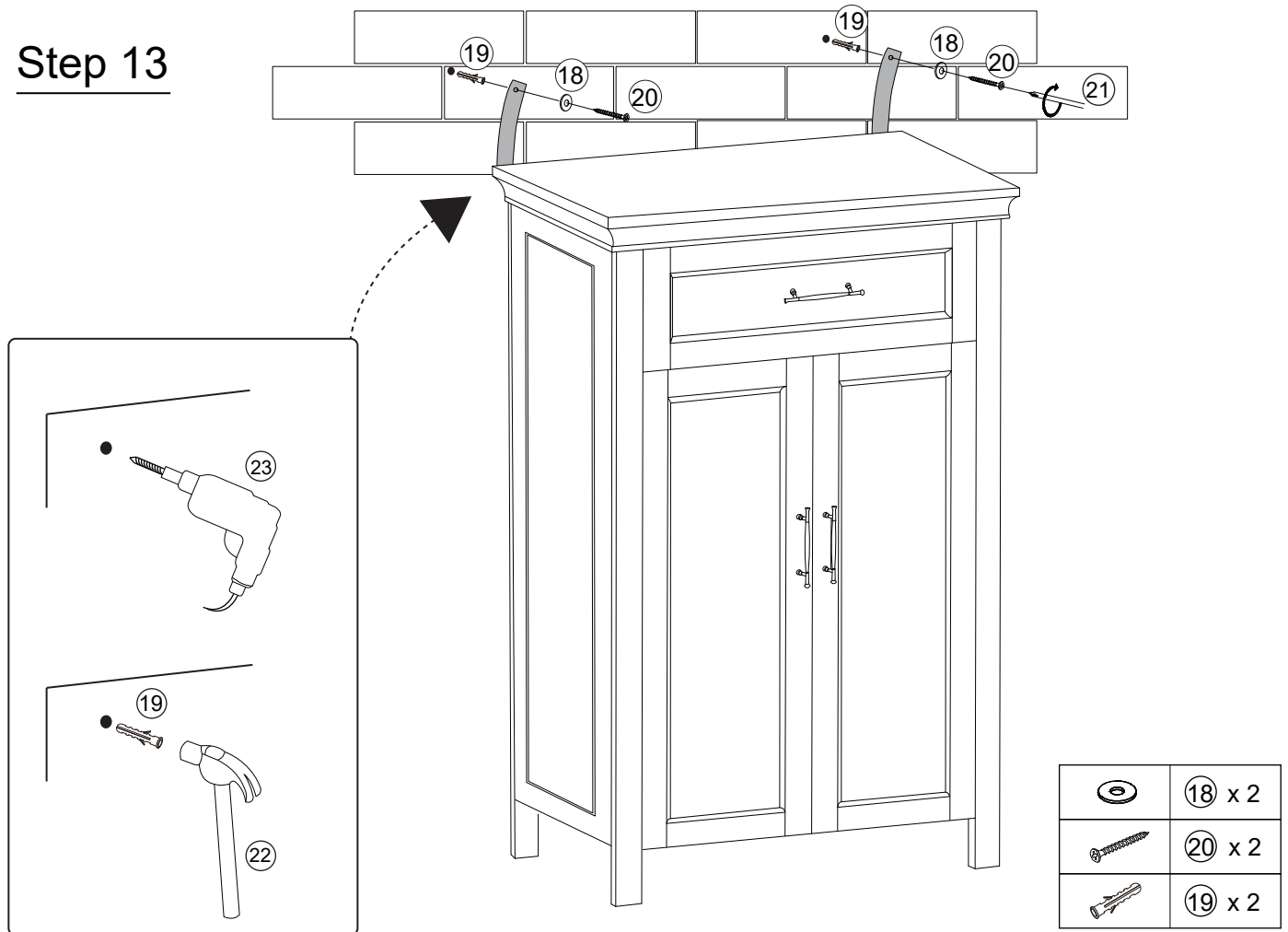

Drill mounting positions on the wall with Power Drill (23), insert Wall Anchor (19) into drilled mounting positions on the wall with Hammer (22). Move the cabinet back to the wall, lock by Screw (21) and Metal Gasket (18) with Screwdriver (21).

Step 14

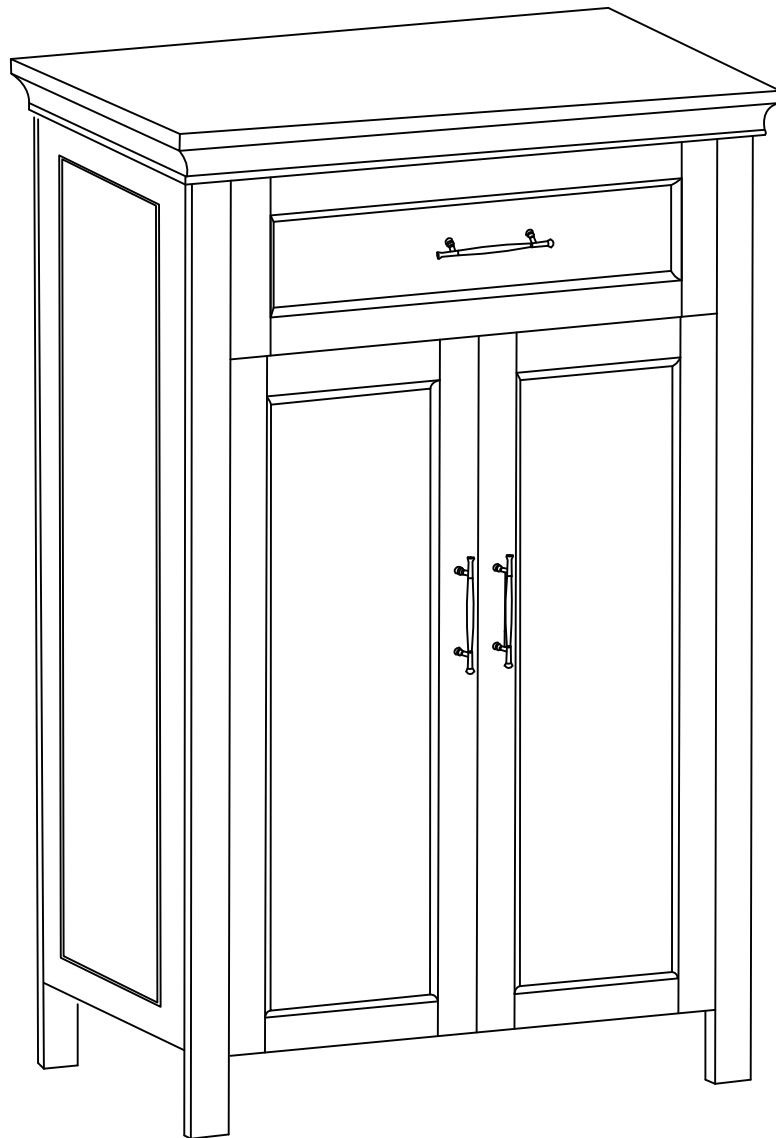

Your Cabinet is ready for use

Care & Maintenance



- Furniture may scratch floors. We recommend using furniture pads to protect your floors.



- Do not put hot items directly on furniture surface.



- Do not clean furniture with harsh cleansers or polish.



- Do not place furniture under direct sunlight.



- Do not place furniture near heating or cooling vents.



- Do not write on furniture without a padded barrier to protect the surface.



- Do not place furniture outside . For indoor use only.



- Not for commercial use. For residential use only.



- Stains may be removed with mild soap solution and damp cloth.



- Children should not climb or jump on the furniture.



- Dust and pick-up spills using a clean, non-colored, lint-free cloth.