

Assembly Instructions

Caution : You must read this before you proceed

CHAIR

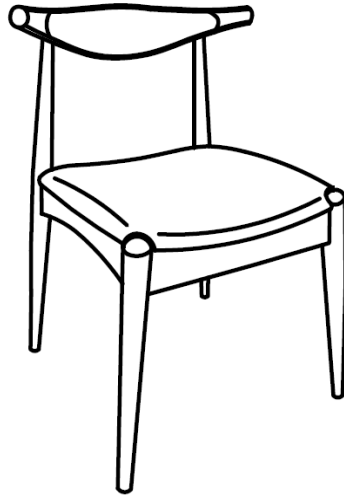





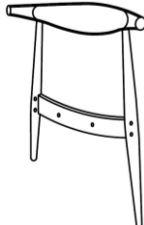
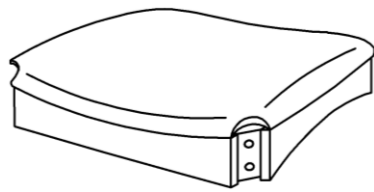

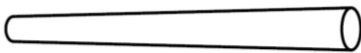
WARNING: These Chairs are intended only for normal use with all four Chair legs on the ground. These Chairs have relatively thin legs and are not designed to be sat in with only two legs on the ground (as from tipping back, forward, or to the side), as such usage can cause stress and failure of one or more Chair legs. Any misuse of the Chairs voids any warranties, expressed or implied.

Parts List

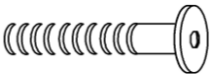
Label	Picture	Description	QTY
A		Backrest	1
B		Seat	1

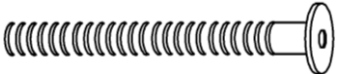
C		Front Leg	2
---	-----------------------------------------------------------------------------------	-----------	---

Hardware

Label	Picture	Description	QTY
①		Bolt (M6 x 35mm)	3
②		Bolt (M6 x 60mm)	5
③		Bolt (M6 x 90mm)	5
④		Spring Washer	11
⑤		Washer	11
⑥		Allen Key	1

Assembly Preparation

Before Beginning Assembly:

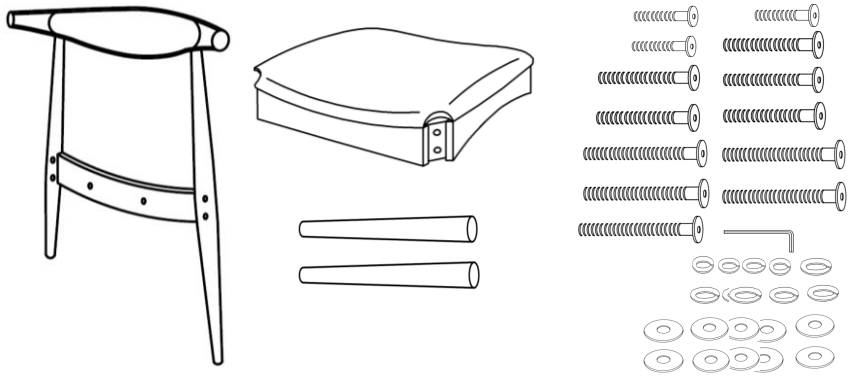

- Read instructions, cover to cover-



- Have 2 adults on hand for assembly-



- Do not assemble on flooring or carpet-



- Assemble on a clean non-marring surface (packing foam)-



- Save all packaging until finished-

Assembly Steps

Overview

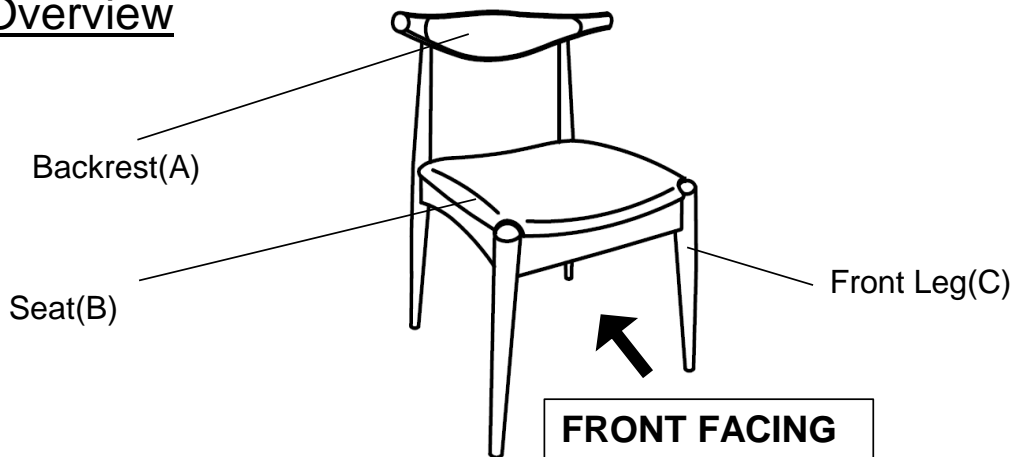

This Chair has multiple parts and may require up to 30 minutes to assemble. To give you an overview of the Chair parts, the above picture is to help you put the various parts into perspective. Please read through the instructions below to familiarise yourself with the parts and steps before assembly.

Step 1

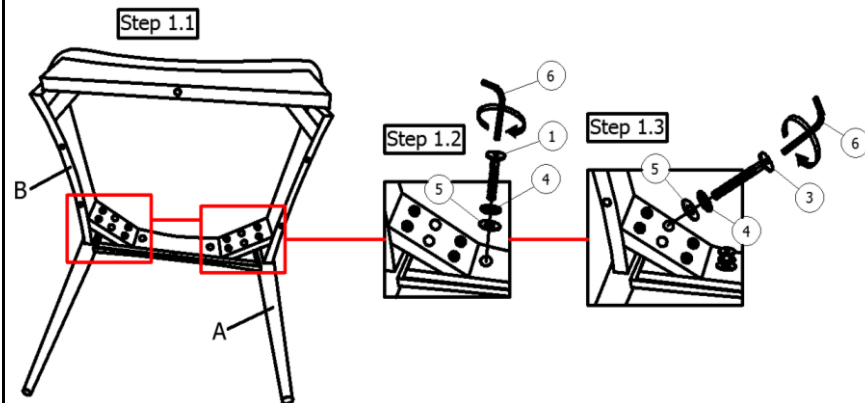

1.1) Align the Seat(B) with Backrest(A) as shown above.

1.2) Attach Seat(B) to Backrest(A) using Bolts(①), Spring Washers(④), and Washers(⑤) with Allen Key(⑥) as pictured above.

1.3) Attach Seat(B) to Backrest(A) using Bolts(③), Spring Washers(④), and Washers(⑤) with Allen Key(⑥) as shown above.

Do not fully tighten the Bolts.

Step 2

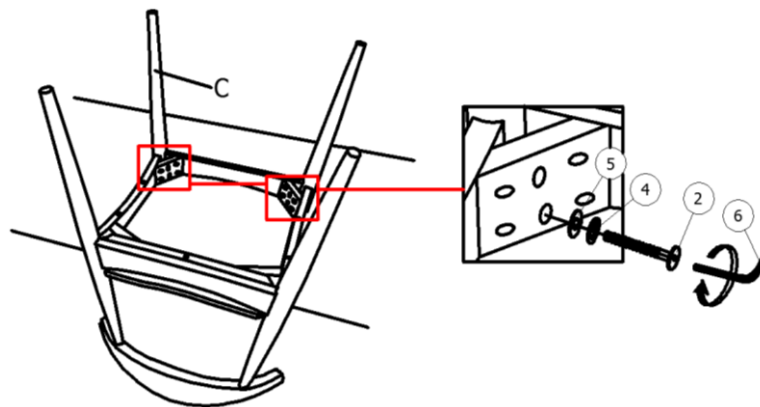

Attach Front Legs(C) to Seat(B) using Bolts(②), Spring Washers(④), and Washers(⑤) with Allen Key(⑥) as pictured above.

Do not fully tighten the Bolts.

Step 3

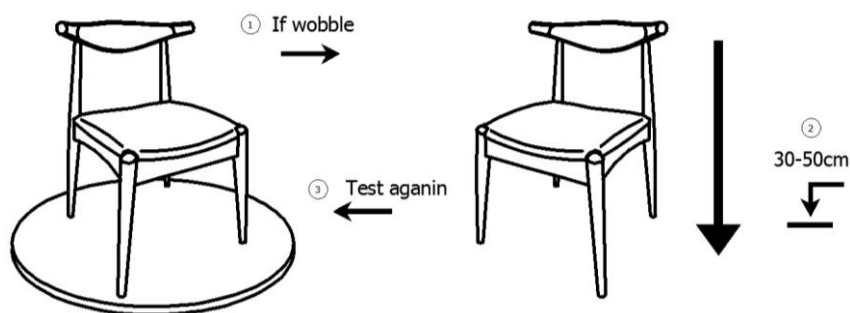

Place the Chair on a LEVEL SURFACE to see if it wobbles.

If it wobbles, lift the Chair some 30cm to 50cm high from the ground.

Keep your feet and toes well away from the drop zone.

Drop the Chair freely and vertically with the four legs, hitting the ground, at the same time.

This Drop Test will help to ensure that all the Bolts and gaps reach full alignment status.

Test again for evenness on a LEVEL SURFACE.

If no wobbles are found, proceed to tighten all the Bolts.

When tightening the Bolts, tighten sequentially.

DO NOT tighten any Bolt fully and then move on to the next one.

This may cause the frame to warp.

If there are still wobbles, loosen the Bolts and execute the same drop test.

If the Chair is not stable it could lead to damage to the product.

Step 4

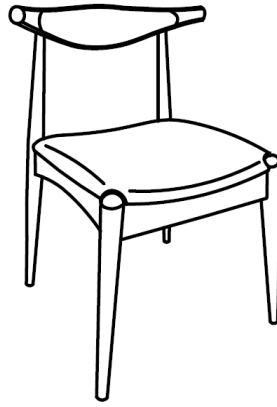





















Inspect and make sure all parts are connected.

Your Chair is ready for use.

This Chair can only be used on a flat, level surface.

Care & Maintenance

Care & Maintenance

-   ● Do not put hot items directly on furniture surface
 -   ● Do not clean furniture with harsh cleansers or polish.
 -   ● Do not place furniture under direct sunlight.
 -   ● Do not place furniture near heating or cooling vents.
 -   ● Do not write on furniture without a padded barrier to protect the surface.
 -   ● Do not place furniture outside . For indoor use only .
 -   ● Not for commercial use. For residential use only .
 -   ● Stains may be removed with mild soap solution and damp cloth.
 -   ● Children should not climb or jump on the furniture.
-
-   ● Dust and pick-up spills using a clean, non-colored, lint-free cloth .

What is Proposition 65?

Proposition 65 is a California law that requires warning labels on products that may contain one of more than 800-plus chemicals or ingredients that the California Office of Environmental Health Hazard Assessment (OEHHA) has deemed to cause cancer or other reproductive toxicity. Chemicals and elements on this list include wood dust, brass, and other everyday substances, which can be found in very common household items, such as: lamps, tableware, jewelry, crystal glasses, electric cords, beauty products, automobiles, and furniture.

Why Did I Find a Proposition 65 Warning on My Home Goods Product?

We include Proposition 65 warnings on all of our products because there is always a chance that one of the 800-plus common chemicals and ingredients listed under this law could potentially be on our furniture or packing materials. We risk large fines under this law, if we don't include this warning.

Should I worry?

We realize you may be worried finding this warning on our products, but we want to reassure you that the hazardous exposure limits for any of these chemicals have never been found on furniture products that we've shipped to our customers. Additionally, this warning label is very common and can be found on almost every piece of furniture sold in the state of California.

Just How Common Are Proposition 65 Warnings?

Proposition 65 warnings have become so common in California that it is hard to take a trip to a local bank, grocery store, or restaurant without finding at least one warning. In fact, even the Disney Land Resort has a Proposition 65 warning:

