

# Assembly Instructions

**Caution: You must read this Assembly Instruction before you proceed.**

## **DINING Chair**





**WARNING:**

These chairs are intended only for normal use with all four chair legs on the ground.

These Chair have relatively thin legs and are not designed to be sat in with only two chair legs on the ground (as in tipping backwards, tipping forward, or to the sides),

Such actions can cause stress and failure to one or more chair legs. Any misuse of the chairs voids any warranties, express or implied.

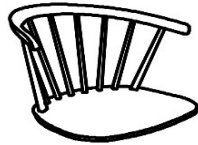
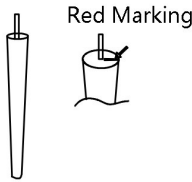
# Parts List

Part NO.	Picture	Description	QTY
A		Chair Seat with Backrest	1 PC
B		Front Leg (With Red Marking)	2 PCS
C		Back Leg	2 PCS
D		Foam Pad	5 PCS

# Assembly Preparation

Before Beginning Assembly:



A

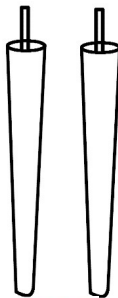

B

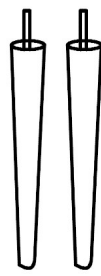

C



- Read instructions, cover to cover-



- Have 2 adults on hand for assembly-



- Do not assemble on flooring or carpet-



- Assemble on a clean non-marring surface (packing foam)-



- Save all packaging until finished-

# Assembly Steps

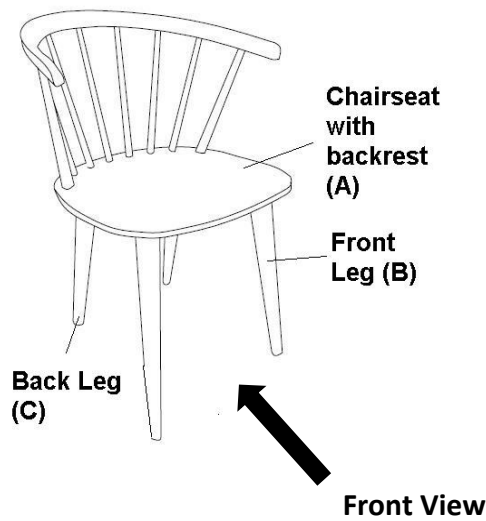

## Overview



This Dining Chair has multiple parts and may require up to 30 minutes to assemble.

To give you an overview of the Chair, the above picture is to help you put the various parts into perspective.

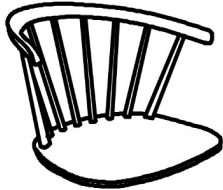
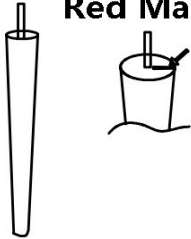
Please read through the **instructions** below to familiarise yourself with the parts and steps before assembly.

<p>Step 1</p>	 <p>A. Chairseat with Backrest</p>	<p>Red Marking</p>  <p>B. Front Leg</p>	
	 <p>C. Back leg</p>		

Open the Carton Box.  
Remove all contents from inside the Carton Box.

Place the Chairseat with Backrest (A) , Front Leg (B) ,and Back Leg (C ) onto a clean, non-marring surface.

Step 2

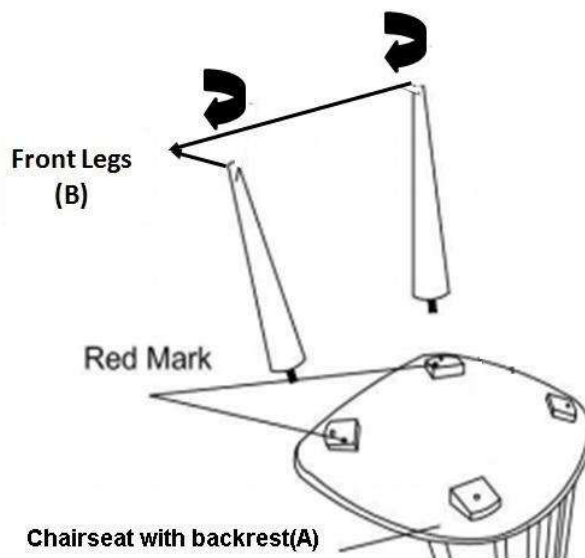

Position the **Chairseat with Backrest (A)** facedown on a clean, non-marring surface.

Insert threaded stem of **Front Leg (B)** into the base of **Chairseat with backrest (A)**, as indicated in above picture.

Proceed to tighten the **Front Leg (B)** by turning the Leg clockwise until completely secure.

**Make sure all parts are connected and securely locked into position**

Step 3.

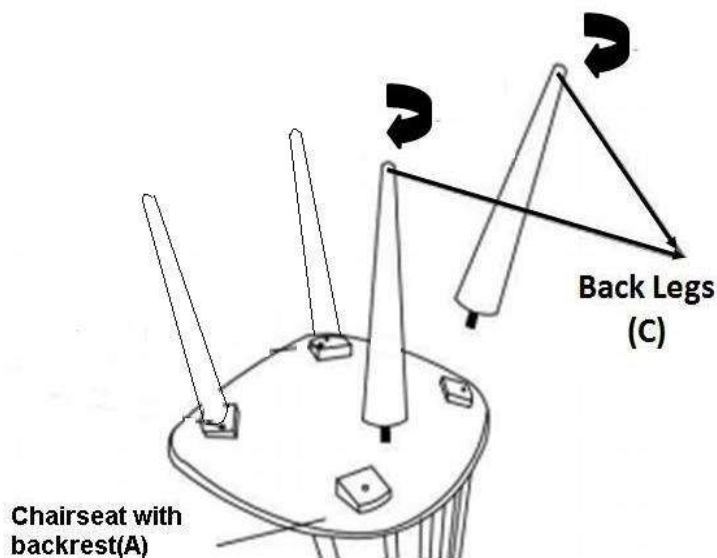

Repeat the Step 2 process with the remaining **Back Leg (c)** legs.

**Make sure all parts are connected and securely locked into position**

Step 4.

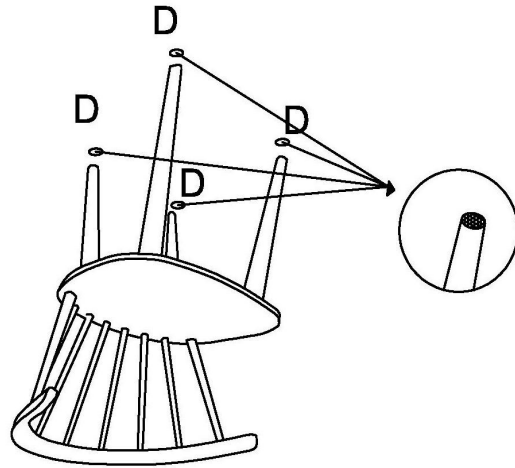

Here, in this step, turn the chair, either, upside down or onto its side.  
Adhere the Foam **Pads (D)** to the floor end of all 4 ( four ) Legs.



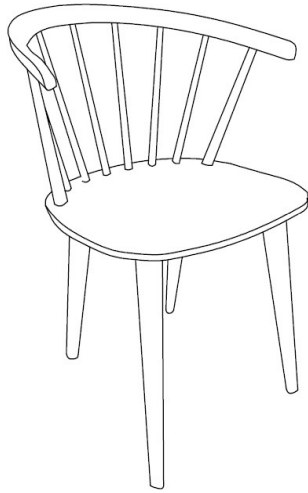







Step 5



Your Dining Chair is ready for use.

**This Dining Chair, is recommended to be used only on a flat, level surface.**

## Care & Maintenance

- ✓  ● Furniture may scratch floors. We recommend using furniture pads to protect your floors.
- ⊘  ● Do not put hot items directly on furniture surface.
- ⊘  ● Do not clean furniture with harsh cleansers or polish.
- ⊘  ● Do not place furniture under direct sunlight.
- ⊘  ● Do not place furniture near heating or cooling vents.
- ⊘  ● Do not write on furniture without a padded barrier to protect the surface.
- ⊘  ● Do not place furniture outside . For indoor use only.
- ⊘  ● Not for commercial use. For residential use only.
- ⊘  ● Stains may be removed with mild soap solution and damp cloth.
- ⊘  ● Children should not climb or jump on the furniture.
- ✓  ● Dust and pick-up spills using a clean, non-colored, lint-free cloth.