

# Heavy Duty Dog Crate

During the assembly of parts, screw in 1 / 2 of the screws, and tighten all screws after the assembly of all parts

**E-MAIL: [PETGROOMINGTABLE@HOTMAIL.COM](mailto:PETGROOMINGTABLE@HOTMAIL.COM)**

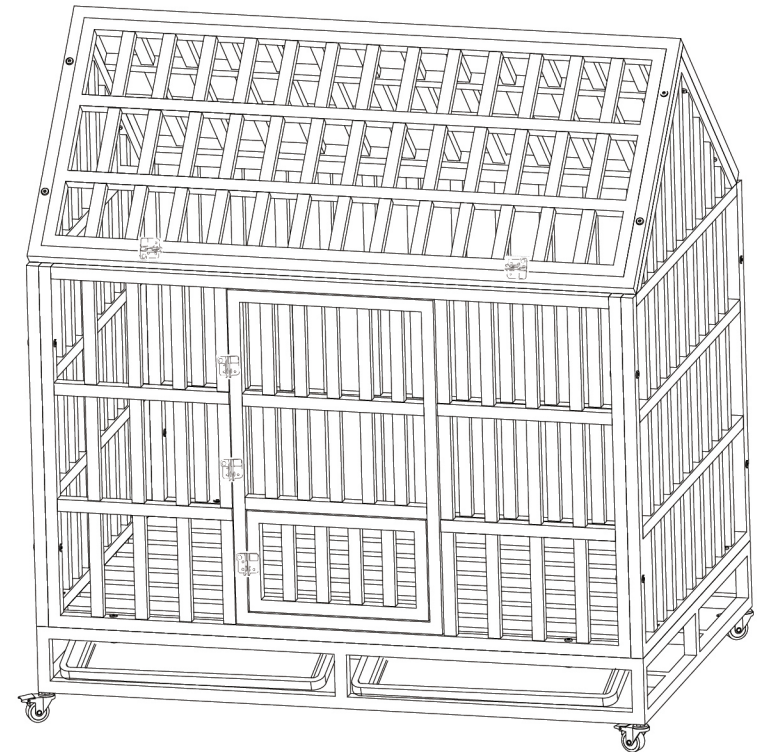

READ AND SAVE THIS INSTRUCTIONS FOR FUTURE USE

**ASSEMBLY & INSTRUCTION MANUAL**

# Parts List



A x 1

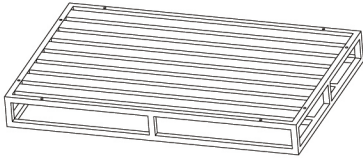

B x 2

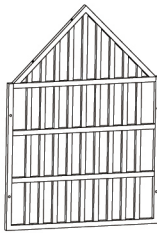

C x 1

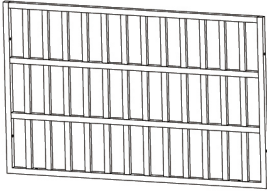

D x 1

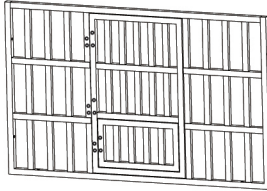

E x 1

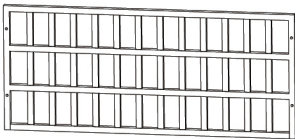

F x 1

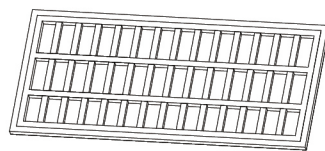

## CAUTION

- READ THE INSTRUCTION MANUAL BEFORE ASSEMBLING
- OPEN THE HARDWARE AS NEEDED
- ASSEMBLE IN AN AREA WITH PLENTY OF SPACE
- READ EACH STEP BEFORE BEGINNING CONSTRUCTION
- NEVER FORCE THE SCREWS OR FITTINGS
- KEEP THIS MANUAL FOR FUTURE REFERENCE
- TIGHTEN ALL THE SCREWS EVERY 6 MONTHS
- DO NOT SHIFT OR DRAG THE PRODUCT AFTER ASSEMBLY
- POWER TOOLS SHOULD NOT BE USED TO ASSEMBLE THIS PRODUCT

# Accessory List

① x 20



(M4 x 10)

② x 24



(M6 x 35)

③ x 24



(M6 x 12)

④ x 4



⑤ x 5



⑥ x 2



TOOLS



## Step 1

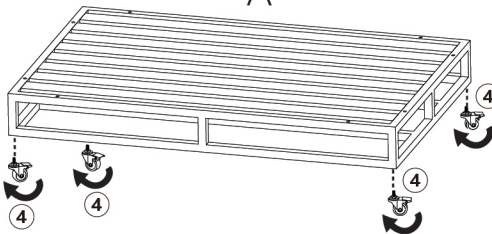

## Step 2

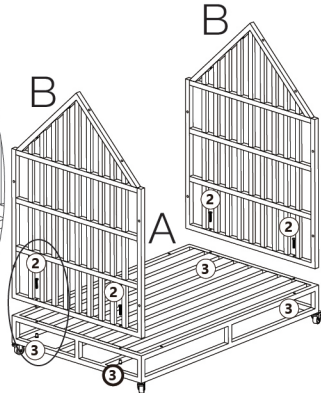
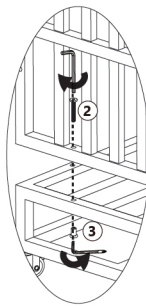

## Step 3

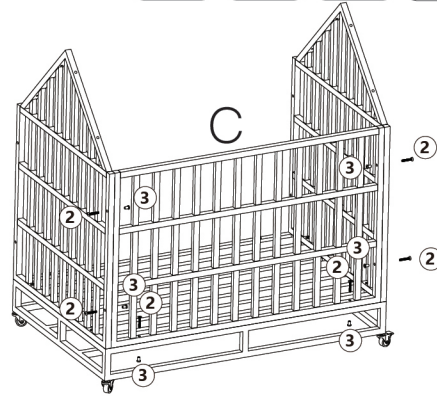

## Step 4

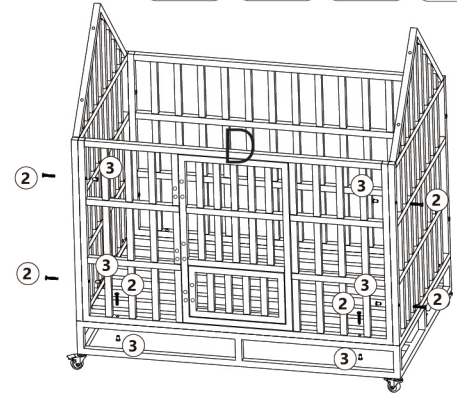

## Step 5

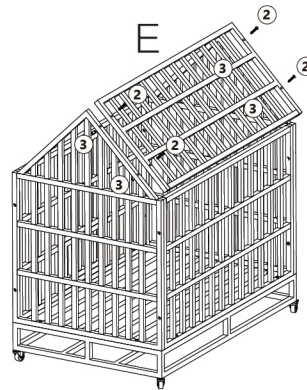

## Step 6

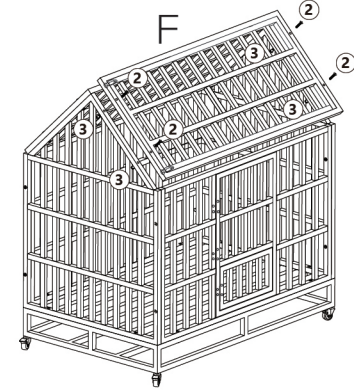

## Step 7

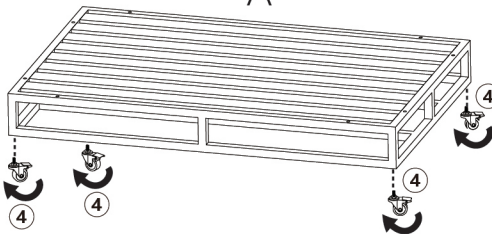

## Step 8



## Step 7

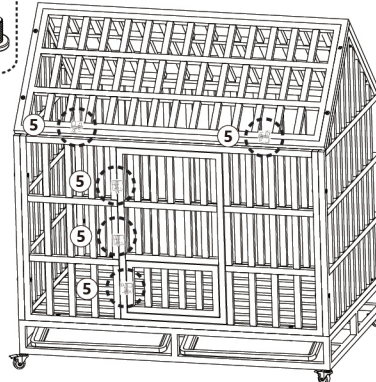
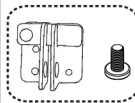

## Step 8

