

PCC-2-13

Double Grid Chicken Coop

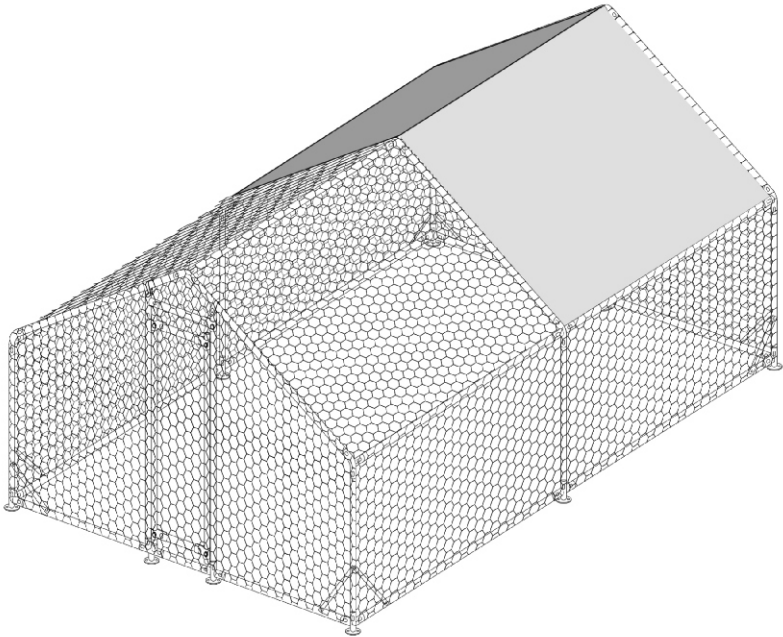

IMPORTANT, RETAIN FOR FUTURE REFERENCE: READ CAREFULLY

ASSEMBLY & INSTRUCTION MANUAL

EN

- 1.This product must be assembled by an adult.
- 2.Do not over torque screws and bolts.
- 3.Do not install in flammable place in case of fire.
- 4.Use on a flat ground.

FR

- 1.Ce produit doit être assemblé par un adulte.
2. Ne serrez pas trop les vis et boulons.
3. N'installez pas le produit à l'endroit inflammable en cas d'incendie.
- 4.Veuillez l'utiliser sur un terrain plat.

ES

- 1.Esta jaula para mascota debe ser ensamblado por un adulto.
- 2.No apriete los tornillos y pernos demasiado.
- 3.Para evitar incendios, no instale la jaula para mascota en un lugar inflamable.
- 4.Utilice la jaula para mascota sobre un terreno plano.

DE

- 1.Dieses Produkt sollte von einem Erwachsenen zusammengestellt werden.
- 2.Ziehen Sie die Schrauben und Bolzen nicht zu fest an.
- 3.Installieren Sie im Brandfall nicht an brennbaren Orten.
- 4.Bitte verwenden Sie es auf einem ebenen Boden.

IT

- 1.Questo prodotto va assemblato da un adulto.
- 2.Non stringere eccessivamente viti e bulloni.
- 3.Non installare in un luogo esposto a potenziali incendi.
- 4.Si prega di usare su una superficie piana.

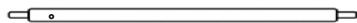

1 x 4
1420



2 x 6
1925



2A x 4
1925



3 x 2
970



3A x 4
970



4 x 6
1540



5 x 1
1687



5A x 1
1687



6 x 1
615



7 x 1
1850



Φ16 400mm

10 x 8
400



A x 2
1600



C x 2
497

D x 5



E1 x 2



E2 x 2



F x 3



G x 1



H x 3



V x 1



I x 16



J x 2

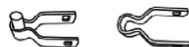

K x 26

M6
+1 (spare)



L x 6

M8
+1 (spare)



M x 1



O x 1

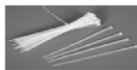

P x 1

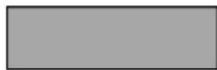

Q x 1

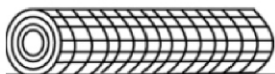

R x 12



S x 1



T x 2



W x 8

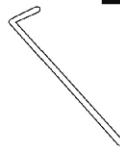



ATTENTION: E1 & E2 shall be placed in strict order, otherwise they cannot be installed

DIFFERENT HOLES SITUATIONS IN E1&E2

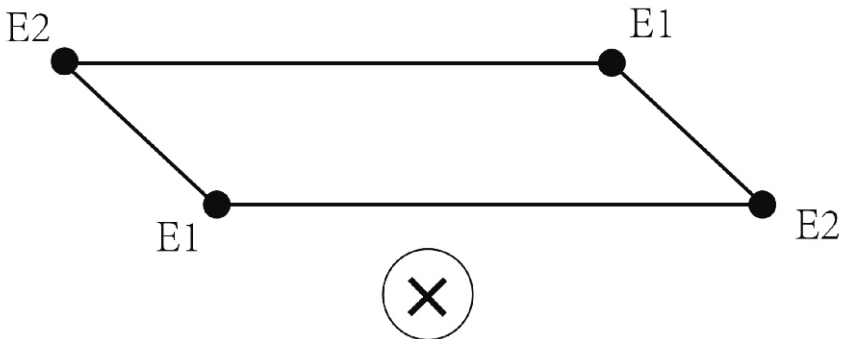
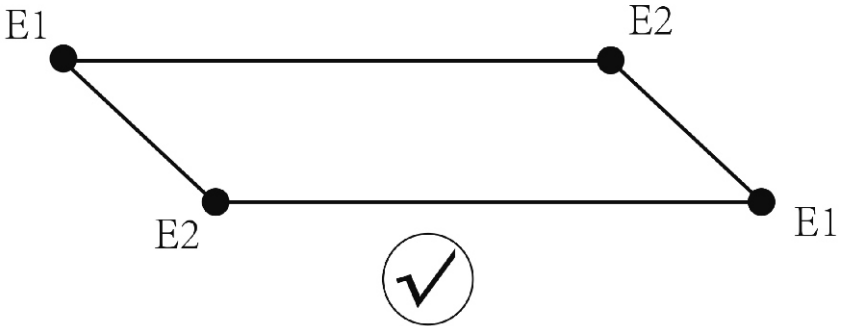
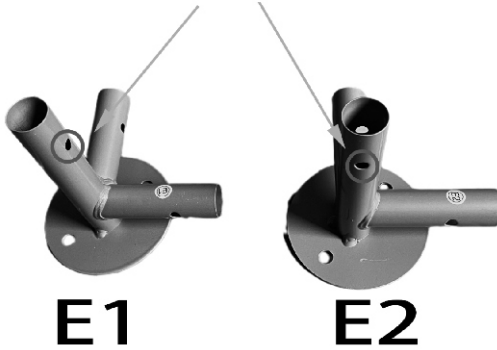

Tips: Firstly pls confirm the door's position and set the right position of E1&E2. Pls be kindly noted that the positions of E1 and E2, cant be opposite.

