

**PCC-3-20**

# METAL CHICKEN COOP

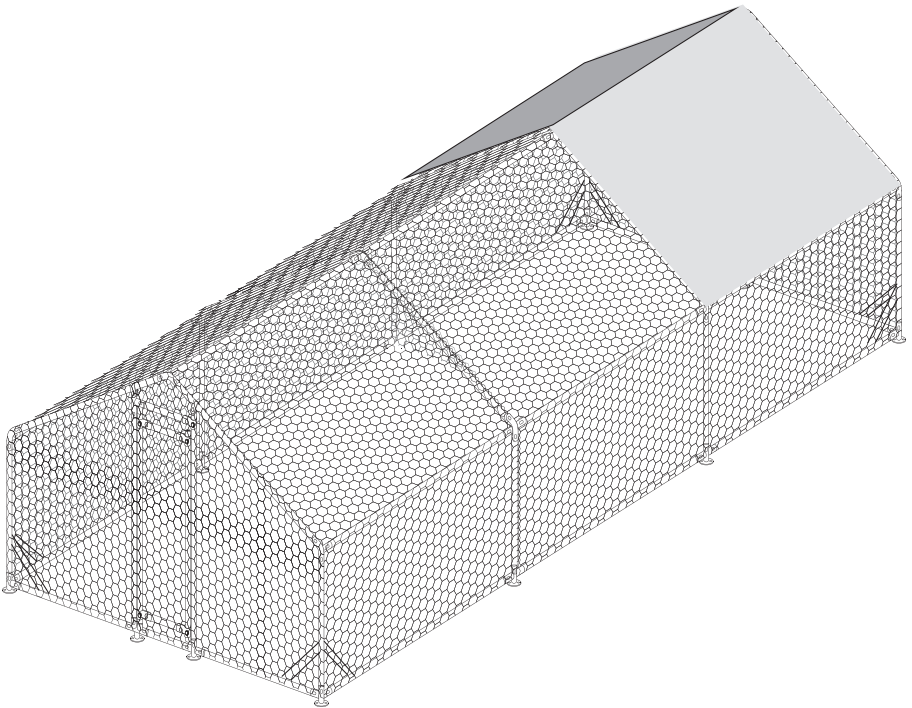

**IMPORTANT, RETAIN FOR FUTURE REFERENCE: READ CAREFULLY**

# ASSEMBLY & INSTRUCTION MANUAL

EN

1. This product must be assembled by an adult.
2. Do not over torque screws and bolts.
3. Do not install in flammable place in case of fire.
4. Use on a flat ground.

FR

1. Ce produit doit être assemblé par un adulte.
2. Ne serrez pas trop les vis et boulons.
3. N'installez pas le produit à l'endroit inflammable en cas d'incendie.
4. Veuillez l'utiliser sur un terrain plat.

ES

1. Esta jaula para mascota debe ser ensamblado por un adulto.
2. No apriete los tornillos y pernos demasiado.
3. Para evitar incendios, no instale la jaula para mascota en un lugar inflamable.
4. Utilice la jaula para mascota sobre un terreno plano.

DE

1. Dieses Produkt sollte von einem Erwachsenen zusammengestellt werden.
2. Ziehen Sie die Schrauben und Bolzen nicht zu fest an.
3. Installieren Sie im Brandfall nicht an brennbaren Orten.
4. Bitte verwenden Sie es auf einem ebenen Boden.

IT

1. Questo prodotto va assemblato da un adulto.
2. Non stringere eccessivamente viti e bulloni.
3. Non installare in un luogo esposto a potenziali incendi.
4. Si prega di usare su una superficie piana.

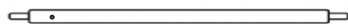

**①** x 4  
1420



**②** x 11  
1925



**②A** x 4  
1925



**③** x 4  
970

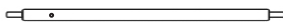

**③A** x 4  
970

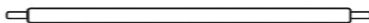

**④** x 8  
1540

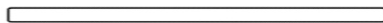

**⑤** x 1  
1687



**⑤A** x 1  
1687

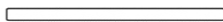

**⑥** x 1  
605



**⑦** x 1  
1850



Φ16 400mm

**⑩** x 8  
400



**A** x 2  
1600



**C** x 2  
497

**D** x 5



**E1** x 2



**E2** x 2



**F** x 5



**G** x 1



**H** x 6



**V** x 1



**I** x 16



**J** x 2



**K** x 26  
M6  
+1(spare)



**L** x 6  
M8  
+1(spare)



**M** x 1



**O** x 1

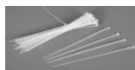

**P** x 1



**Q** x 1

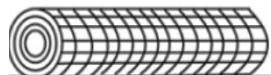

**R** x 12



**S** x 1



**T** x 2



**W** x 10

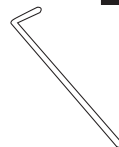

DIFFERENT HOLES SITUATIONS  
IN E1 & E2



**E1**



**E2**

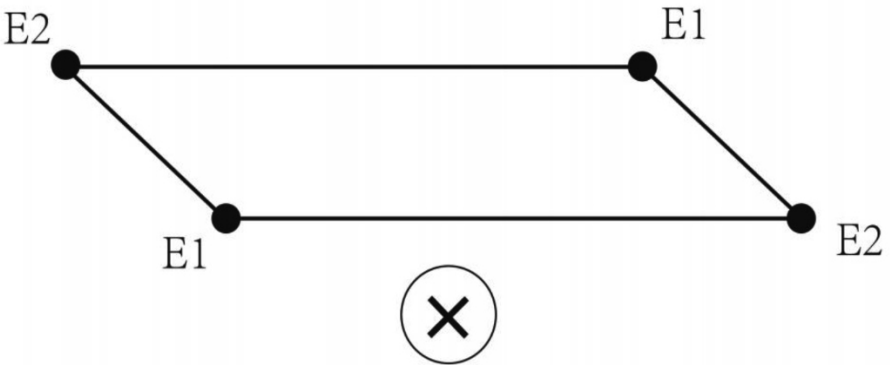
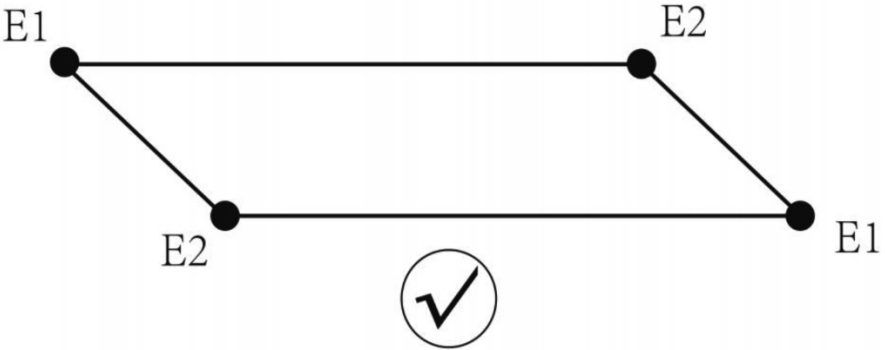

Tips: Firstly pls confirm the doors position and set the right position of E1 & E2. Pls be kindly noted that the positions of E1 and E2, cant be opposite.

