

# Instruction Manual

Please save this manual for future reference.







Product Name:	Whitewashed Wood 2-Drawer 1-Shelf Console and Entry
SKU #:	W2295P187493-H1100

Thank you for purchasing this product. This product has been manufactured with the highest standards of safety and quality.

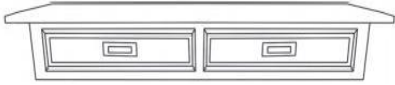
**PLEASE READ ALL INSTRUCTIONS BEFORE ASSEMBLY.**

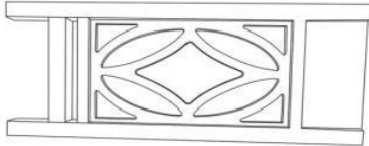
Unpack all parts from Styrofoam and bubble wrap inside the carton to ensure there are no missing or damaged parts. If any parts are missing or damaged, do not attempt to assemble or use the product.

**CARTON CONTENTS:**

1		Short Screw	Φ 12*30mm	8pcs	A		1pc
2		Long Screw	中12*40mm	4pcs	B		2pcs
3		Flat washer	中17mm	12pcs	C		1pc
4		Allen wrench	Φ 5*65mm	1pc			

# Instruction Manual

Please save this manual for future reference.

Product Name:	Whitewashed Wood 2-Drawer 1-Shelf Console and Entry
SKU #:	W2295P187493-H1100

## Assembly Instructions

### STEP 1:

Insert (B) to (A). Align and tighten Short screw (1) & flat washer (3) by Allen wrench (4)

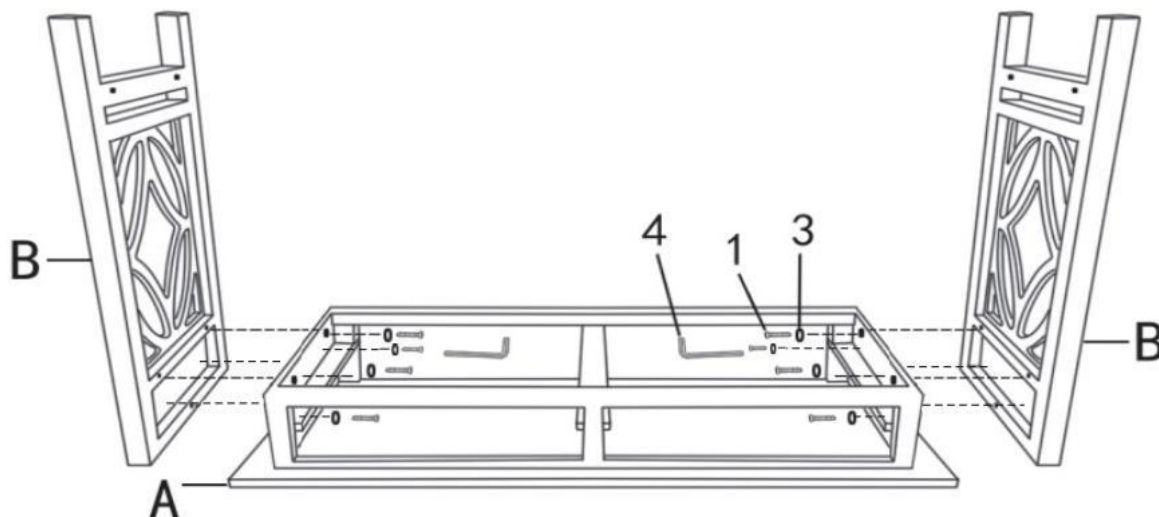

### STEP 2:

Insert (C) to (B). Align and tighten Long screw (2) & flat washer (3) by Allen wrench (4)

