

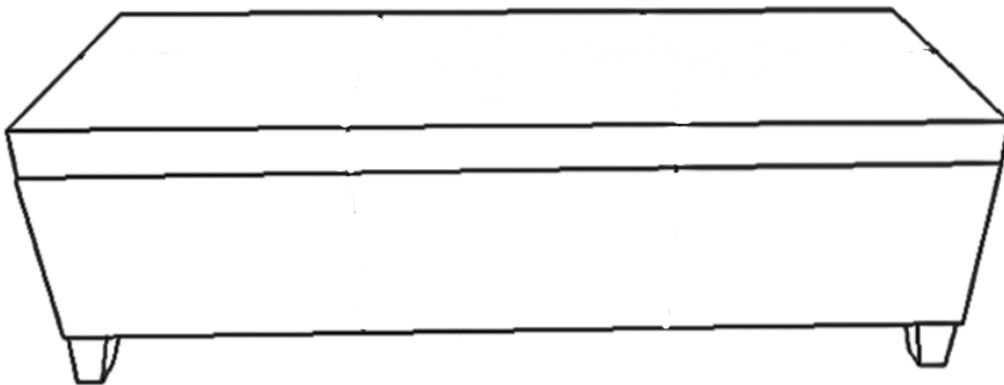

Assembly Instructions

Caution : You must read this before you proceed

Ottoman



Parts List

Label	Picture	Description	QTY
A		Ottoman	1
B		Wooden Leg	4

Hardware

Label	Picture	Description	QTY
①		Washer Ring	7

Assembly Preparation

Before Beginning Assembly:

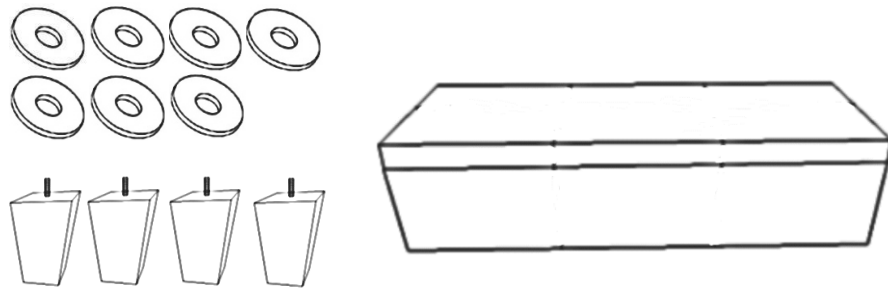

- Read instructions, cover to cover-



- Have 2 adults on hand for assembly-



- Do not assemble on flooring or carpet-



- Assemble on a clean non-marring surface (packing foam)-



- Save all packaging until finished-

Assembly Steps

Overview

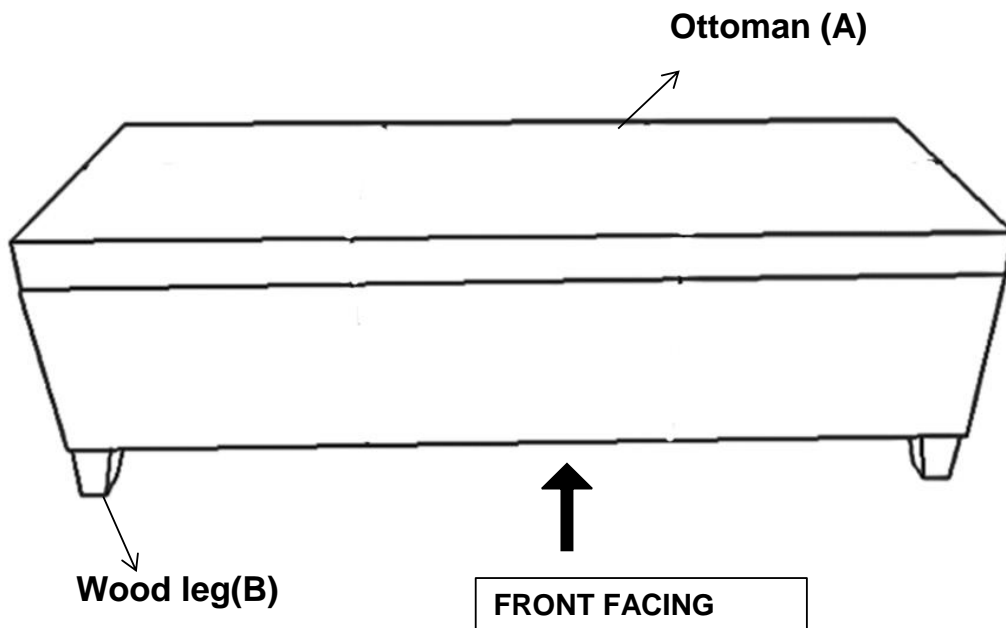

This Ottoman has multiple parts and may require up to 30minutes to assemble. To give you an overview of the ottoman parts, the above picture is to help you put the various parts into perspective. Please read through the instructions below to familiarise yourself with the parts and steps before assembly.

Step 1

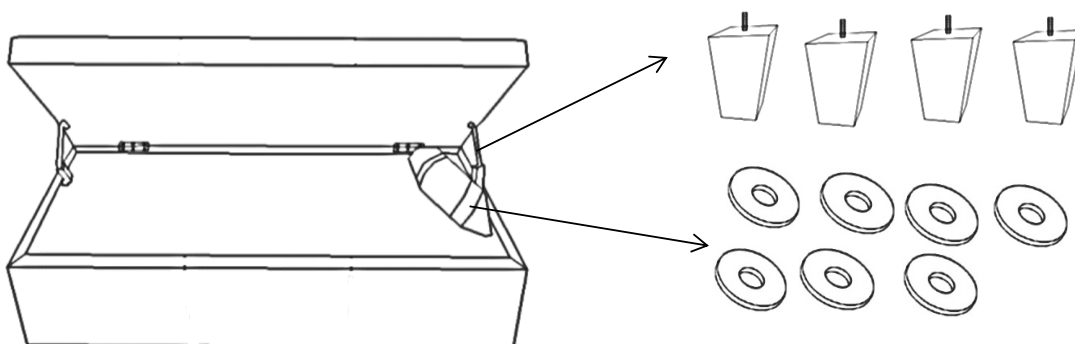

Open up the carton box and take the Ottoman out and place onto a clean soft surface.

Then open up the Storage Ottoman.

Take out the package from inside the Ottoman.

Open up this package and remove the 4 Wooden Legs and its contents.

Step 2

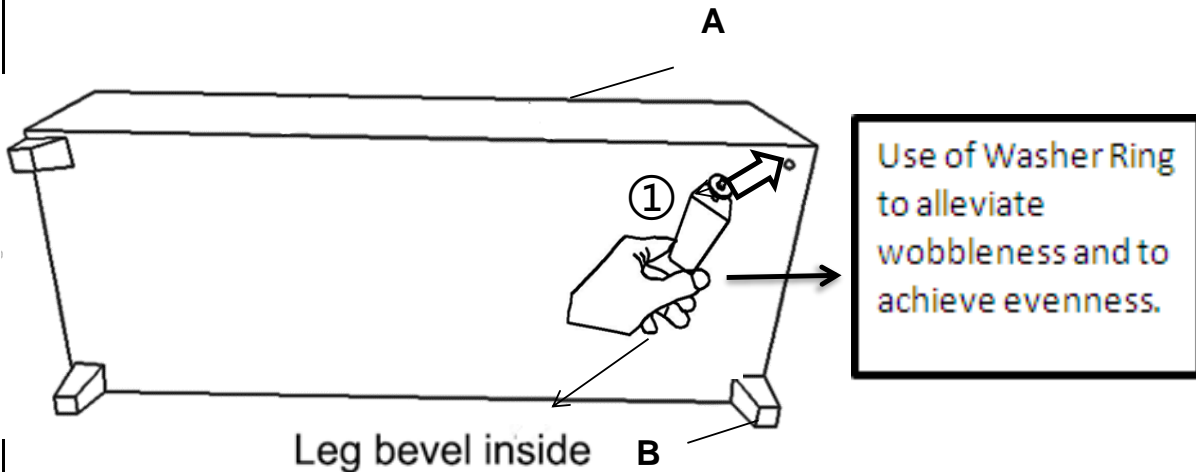

Install the first leg(B) into the bottom of the Storage Ottoman(A) by placing 1 (ONE) piece of Washer Ring on the threaded stem. The use of Washer Rings improves tightness and security of leg after assembly.

Tighten by turning the leg clockwise.

Repeat the same step to install the three remaining legs.

Note : The use of Washer Rings are OPTIONAL and is especially useful to help alleviate slight wobbleness . Some Legs may need more than one whilst some legs do not need any.

Step 3

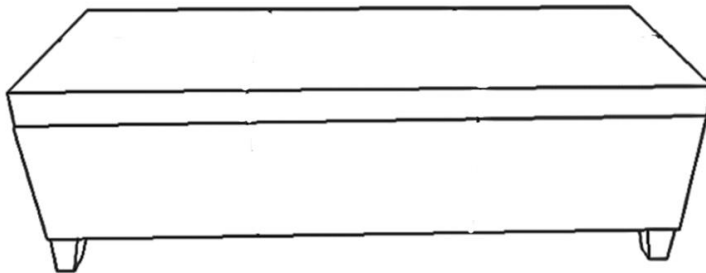

Place the Storage Ottoman right side up, test for evenness. Where you find this Storage Ottoman being uneven, identify the corresponding leg and "add or remove" a Washer Ring to achieve evenness.

Turn the Ottoman the right side up and it is ready for use.

This Ottoman can only be used on a flat, level surface.

Care & Maintenance



- Furniture may scratch floors. We recommend using furniture pads to protect your floors.



- Do not put hot items directly on furniture surface.



- Do not clean furniture with harsh cleansers or polish.



- Do not place furniture under direct sunlight.



- Do not place furniture near heating or cooling vents.



- Do not write on furniture without a padded barrier to protect the surface.



- Do not place furniture outside . For indoor use only.



- Not for commercial use. For residential use only.



- Stains may be removed with mild soap solution and damp cloth.



- Children should not climb or jump on the furniture.



- Dust and pick-up spills using a clean, non-colored, lint-free cloth.