

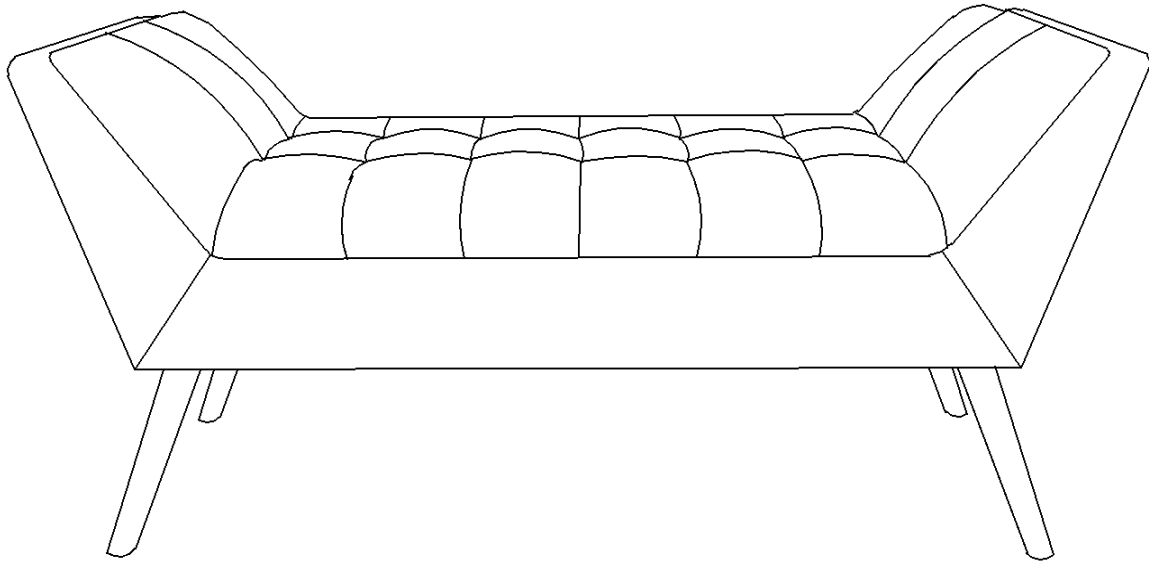

# Assembly Instructions

## Bench

**Caution** : You must read this before you proceed.



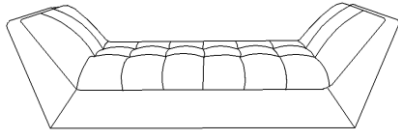



### Parts List

| Label | Picture   | Description | Qty |
|-------|---|-------------|-----|
| A     |  | Bench Seat  | 1   |
| B     |  | Legs        | 2   |

|   |  |      |   |
|---|--|------|---|
| C |  | Legs | 2 |
|---|--|------|---|

## Hardware

| Label | Picture   | Description     | Qty |
|-------|---|-----------------|-----|
| ①     |  | Bolt (M8X50mm ) | 9   |
| ②     |  | Spring Washer   | 9   |
| ③     |  | Washer          | 9   |
| ④     |  | Allen Key       | 1   |

## Assembly Preparation

Before Beginning Assembly:

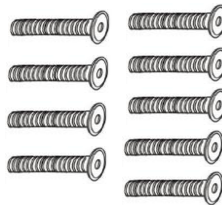
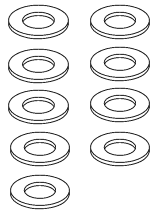
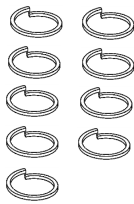
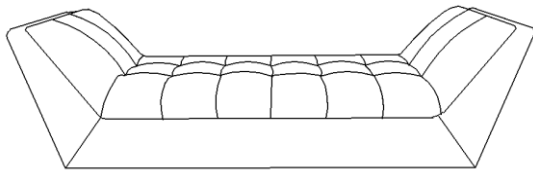

- Read instructions, cover to cover-



- Have 2 adults on hand for assembly-



- Do not assemble on flooring or carpet-



- Assemble on a clean non-marring surface (packing foam)-



- Save all packaging until finished-

# Assembly Steps

## Overview

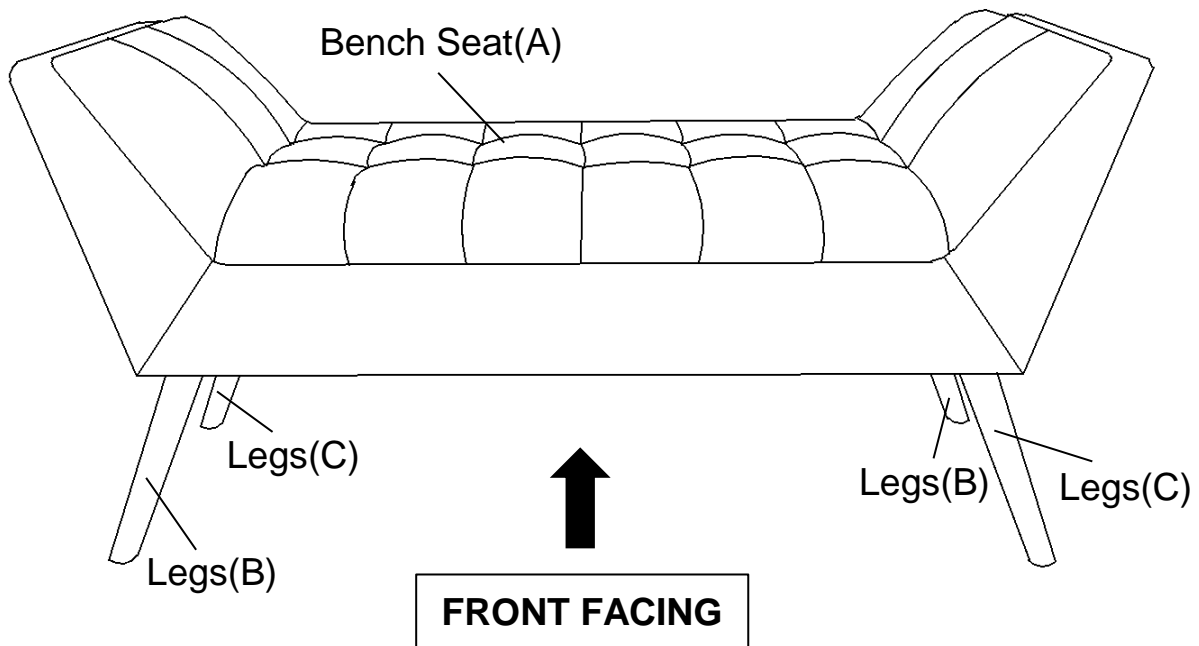

This Bench has multiple parts and may require up to 30 minutes to assemble. To give you an overview of the Bench parts, the above picture is to help you put the various parts into perspective. Please read through the instructions below to familiarise yourself with the parts and steps before assembly.

## Step 1

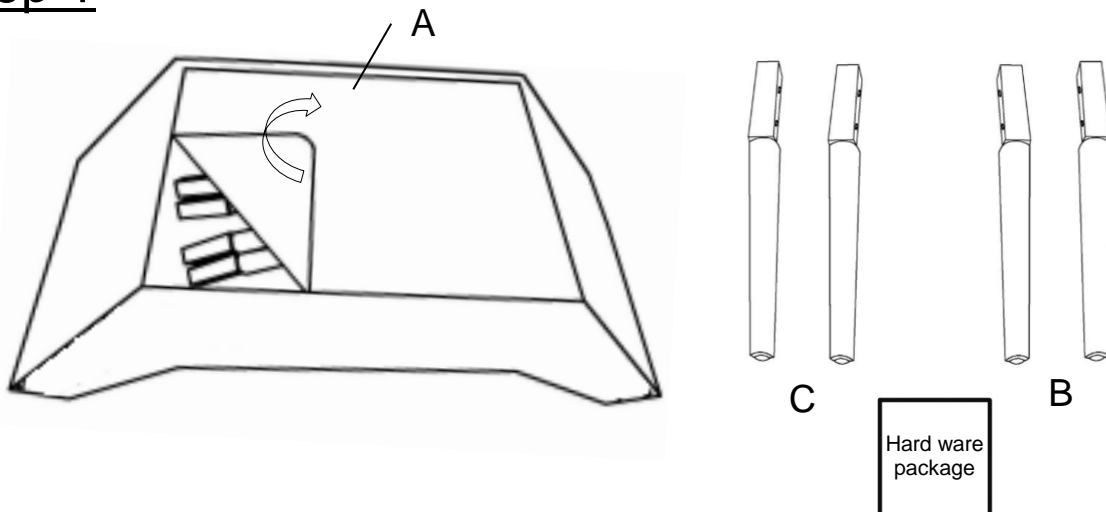

With assistance from your adult partner, Carefully place the Bench Seat(A) face down on a clean, non-marring surface.  
Remove the non-woven bottom cover as shown in above picture.  
Take out Legs(B), Legs(C) and hardware package. Open hardware package, and take out all hardware aside.

## Step 2

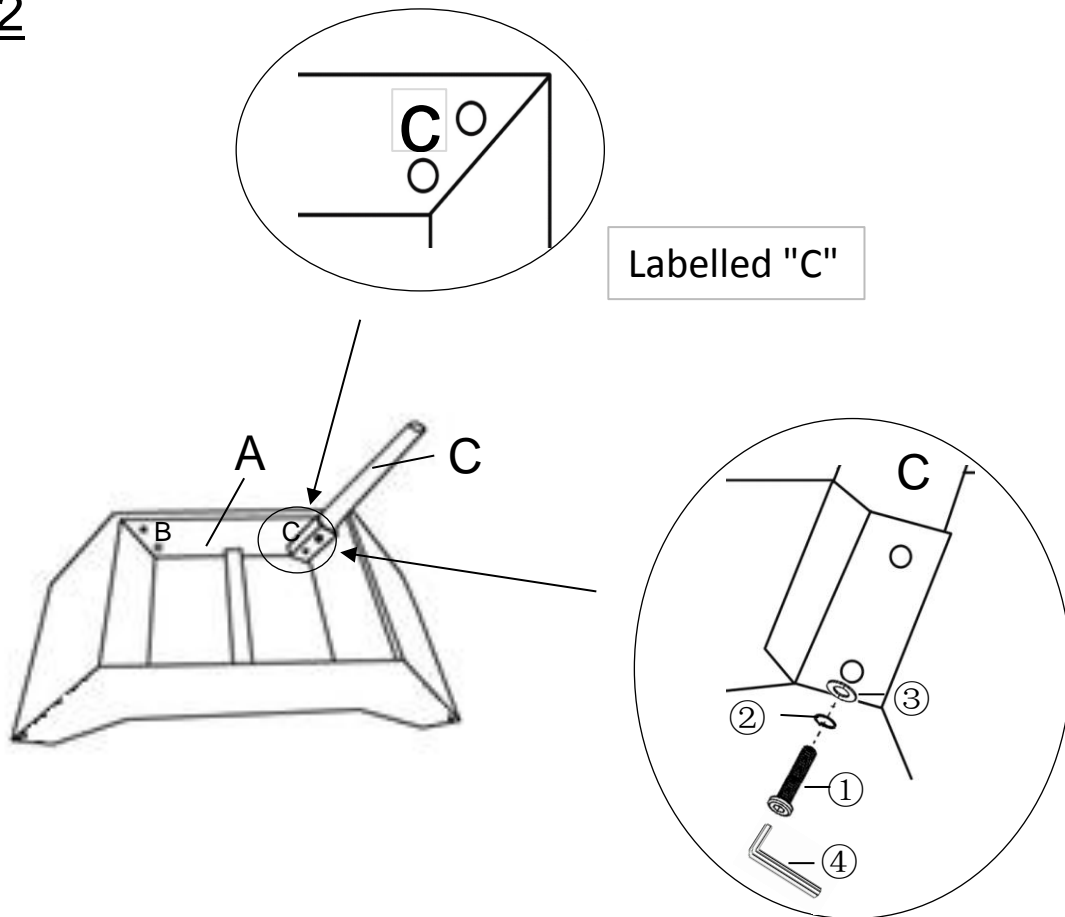

Align the mounting positions on the Legs(C) to those on the underside of Bench Seat(A). Attach one Leg(C) to Bench Seat(A) using two Bolts(①), two Washers(②) and two Spring Washers(③) with Allen Key(④).

**DO NOT tighten a Bolt fully and then move on towards another one.**

Repeat the same process with the remaining three Legs.

**There are Labels 'B' and 'C' on the bottom mounting positions of Bench Seat(A).**

**Please be sure to use Legs(B) with Label 'B' and Legs(C) with Label 'C'.**

## Step 3

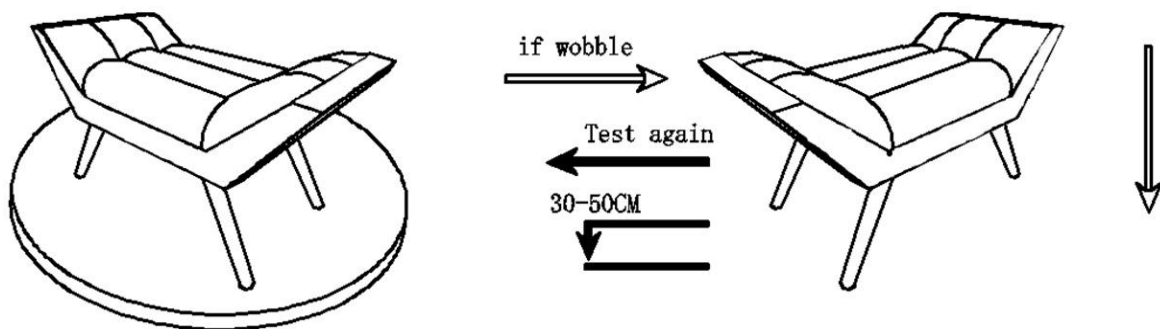

Place the Bench on a LEVEL SURFACE to see if it wobbles.  
If it wobbles, lift the bench some 30cm to 50cm high from the ground.  
Keep your feet and toes well away from the drop zone.  
Drop the bench freely and vertically with the four legs, hitting the ground, at the same time.  
This Drop Test will help to ensure that all the Bolts and gaps reach full alignment status.  
Test again for evenness on a LEVEL SURFACE.  
If no wobbles are found, proceed to tighten all the Bolts.  
**When tightening these Bolts, tighten sequentially.**  
**DO NOT tighten any Bolt fully and then move on towards the next one.**  
**This would cause the frame to warp.**  
If there are still wobbles, loosen the Bolts and execute this same drop test.

## Step 4

Step 4.1

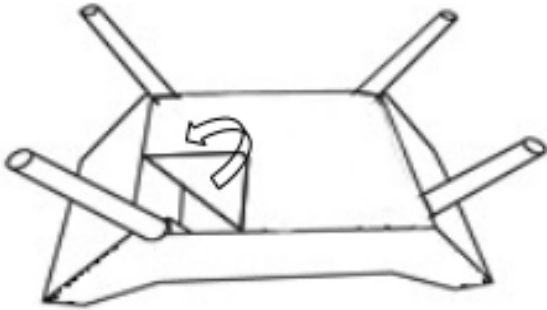

Step 4.2

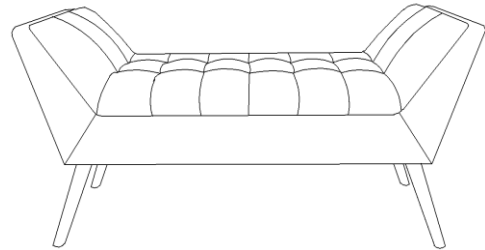

### Step 4.1

Lay down the Bench facedown on a clean non-marring surface.  
Seal the non-woven bottom cover back to the underside of the Bench.















### Step 4.2

Stand the Bench up. Inspect and make sure all parts are connected, locked and fully secured into position.

Your Bench is ready for use.

**This Bench can only be used on a flat, level surface.**

## Care & Maintenance

-   Do not put hot items directly on furniture surface.
  -   Do not clean furniture with harsh cleansers or polish.
  -   Do not place furniture under direct sunlight.
  -   Do not place furniture near heating or cooling vents.
  -   Do not write on furniture without a padded barrier to protect the surface.
  -   Do not place furniture outside . For indoor use only .
  -   Not for commercial use. For residential use only .
  -   Stains may be removed with mild soap solution and damp cloth.
  -   Children should not climb or jump on the furniture.
- 
-   Dust and pick-up spills using a clean, non-colored, lint-free cloth .

## What is Proposition 65?

Proposition 65 is a California law that requires warning labels on products that may contain one of more than 800-plus chemicals or ingredients that the California Office of Environmental Health Hazard Assessment (OEHHA) has deemed to cause cancer or other reproductive toxicity. Chemicals and elements on this list include wood dust, brass, and other everyday substances, which can be found in very common household items, such as: lamps, tableware, jewelry, crystal glasses, electric cords, beauty products, automobiles, and furniture.

## Why Did I Find a Proposition 65 Warning on My Home Goods Product?

We include Proposition 65 warnings on all of our products because there is always a chance that one of the 800-plus common chemicals and ingredients listed under this law could potentially be on our furniture or packing materials. We risk large fines under this law, if we don't include this warning.

## Should I worry?

We realize you may be worried finding this warning on our products, but we want to reassure you that the hazardous exposure limits for any of these chemicals have never been found on furniture products that we've shipped to our customers. Additionally, this warning label is very common and can be found on almost every piece of furniture sold in the state of California.

## Just How Common Are Proposition 65 Warnings?

Proposition 65 warnings have become so common in California that it is hard to take a trip to a local bank, grocery store, or restaurant without finding at least one warning. In fact, even the Disney Land Resort has a Proposition 65 warning:

