

Assembly Instructions

Storage Ottoman

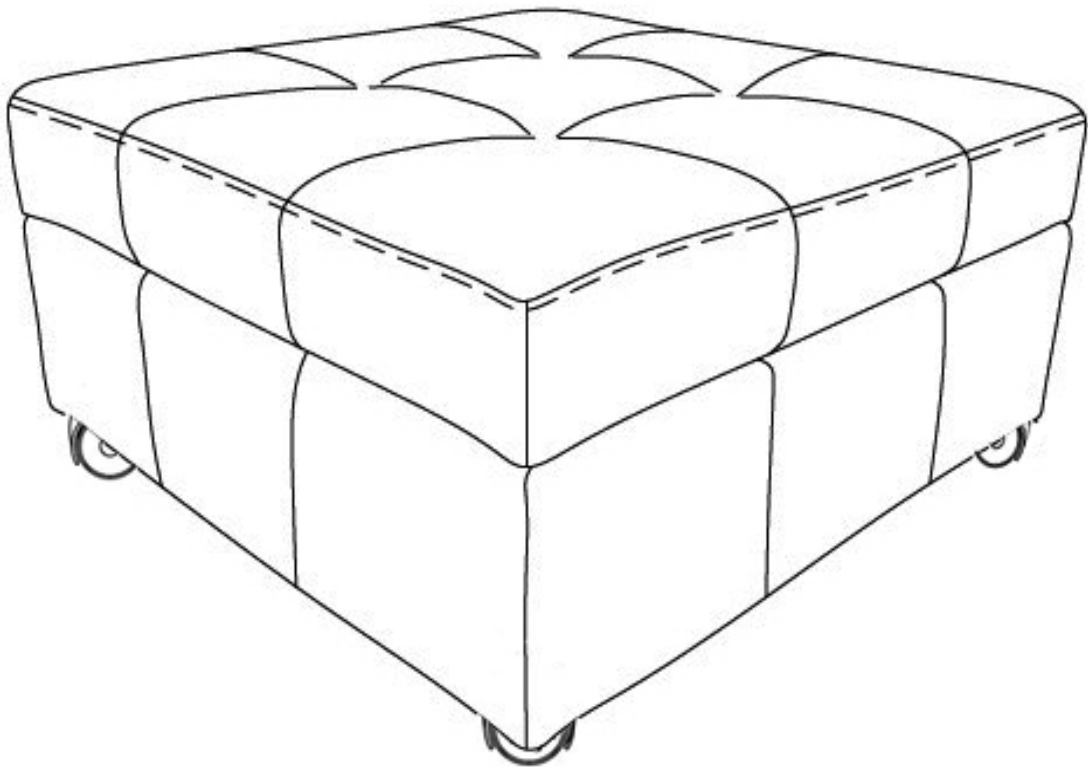
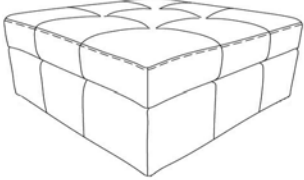
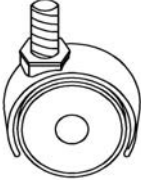

Parts List

Label	Picture	Description	QTY
A		Ottoman	1PC
B		Casters	4PCS





Hardware

Label	Picture	Description	QTY
1		Wrench	1PC

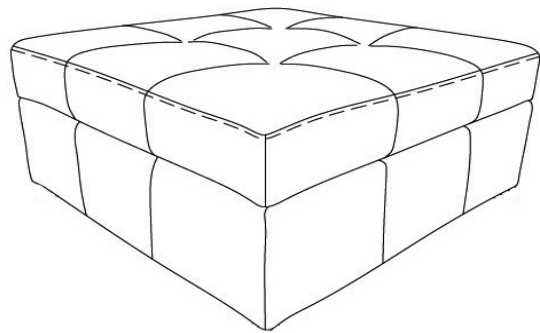
Assembly Preparation

Before Beginning Assembly:



-  • Read instructions, cover to cover-
-  • Have 2 adults on hand for assembly-
-  • Do not assemble on flooring or carpet-
-  • Assemble on a clean non-marring surface (packing foam)-

Assembly Steps

Step 1

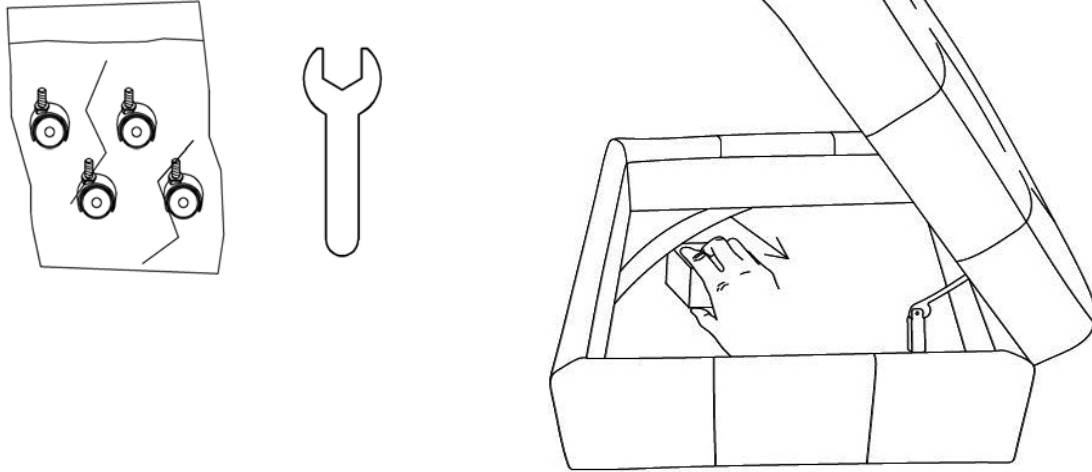

Open up the Storage Ottoman and take out the bag with parts inside the Ottoman.
Retrieve the Casters and Wrench.
Place the components on a clean and soft surface.

Step 2

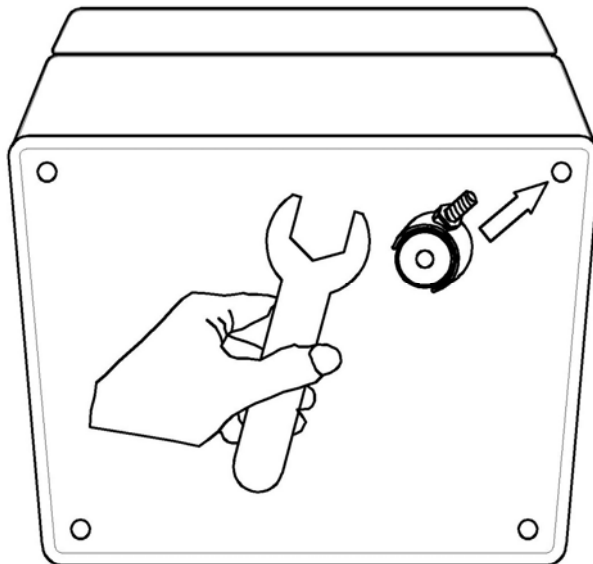





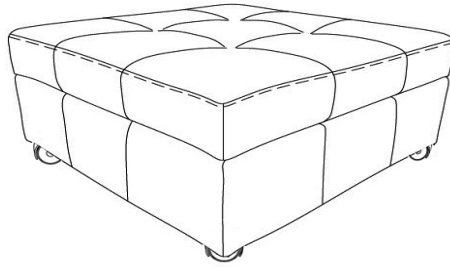













Position the Ottoman on its side.
Install the first Caster into the bottom of the Storage Ottoman.
Install by inserting the threaded stem into the threaded hole at each corner of the Storage Ottoman.
Tighten by turning the Wrench clockwise.
Repeat the same process of installation with the three remaining Casters.

Step 3



Place the Storage Ottoman right side up and it is ready for use.

Care & Maintenance

-   • Do not put hot items directly on furniture surface.
 -   • Do not clean furniture with harsh cleansers or polish.
 -   • Do not place furniture under direct sunlight.
 -   • Do not place furniture near heating or cooling vents.
 -   • Do not write on furniture without a padded barrier to protect the surface.
 -   • Do not place furniture outside. For indoor use only.
 -   • Not for commercial use. For residential use only.
 -   • Stains may be removed with mild soap solution and damp cloth.
-
-   • Dust and pick-up spills using a clean, non-colored, lint-free cloth.