

Installation Instruction of Concealed Shower System

Installation Manual

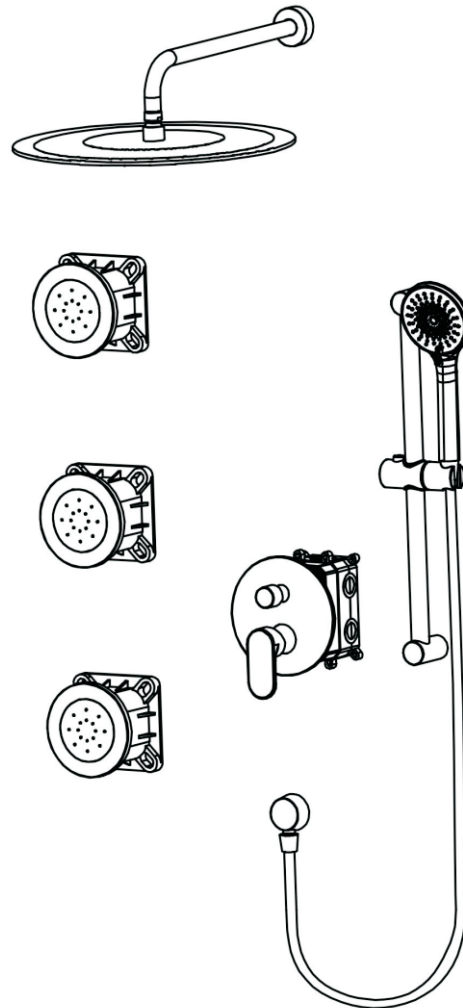

Installation: before drilling, please use electronic detector to confirm whether there is power line communication cable or water pipe in the wall. If you use an electric drill, remember two points: Please wear protective goggles. Turn off the power after using the device.

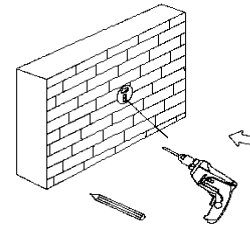

Installation of fixed base: first determine the installation hole and mark; Use a special drill to pierce the ceramic tile to prevent the ceramic tile from breaking. Hammer drill to drill the fixed hole of expansion adhesive and punch in the expansion adhesive. Fix the base on the wall with self-tapping screws, and use a screwdriver to tighten the self-tapping screws so that the base does not fall off.

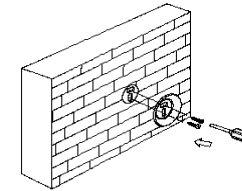

According to the size of the object to determine the location of the installation hole, mark, with a special method to install the fixed base on the wall. Then insert the lifting rod into the fixed base, and tighten the top wire with an inner hexagon wrench to prevent the lifting rod from falling off.

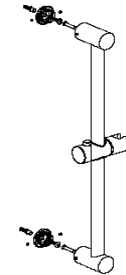

Three functions with side spray water dark flower shower set

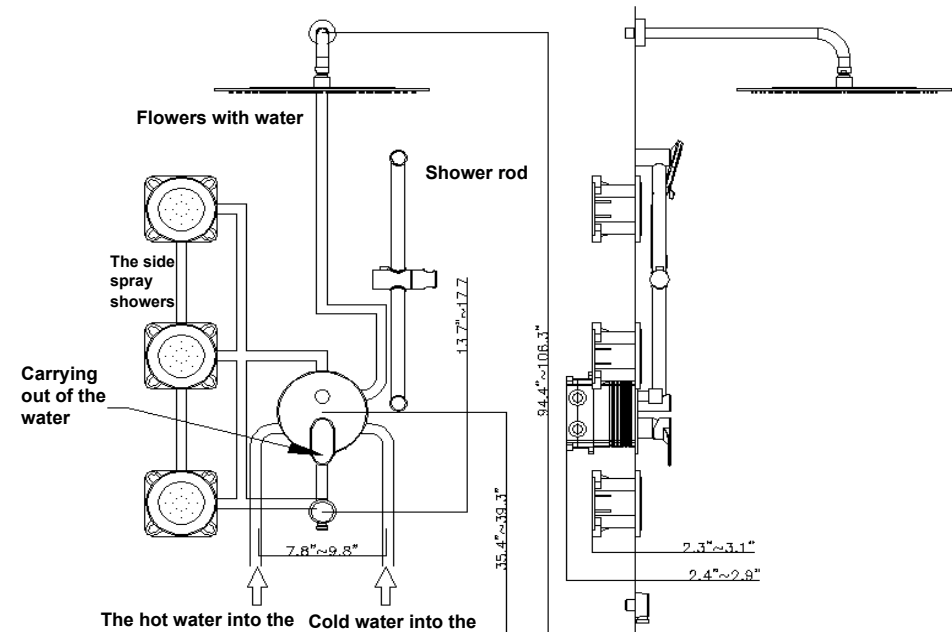

Note: All dimensioning or dimensioning instructions in this manual are in "inches"

INSTALLATION STEPS

2. Installation steps of side spray and shower head

1). Keep the bottom of the hole flat, adjust the vertical and horizontal of the embedded box, fix the embedded box with screws, and tighten the joint with a hexagonal wrench;

2). Tighten the connector with a hexagonal wrench and cover the installation cover;

3). Tighten the joint with a hexagonal wrench and test the water without leakage;

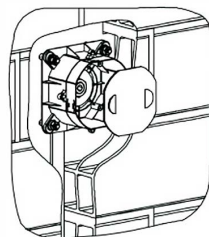
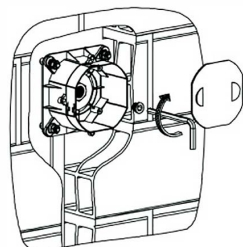
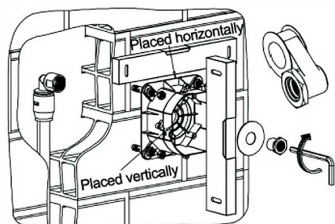

4). Laying wall tiles or other decorative walls, remove the plug, open the switch valve core, and keep it for a period of time to clean and manage foreign objects to prevent affecting the water outlet function;

5). With the aid of the mounting pad, and cut off the protruding part of the embedded box with a cutting knife;

6). Tighten the connecting rod, disassemble the spray body and the decorative cover, first fix the spray body with screws;

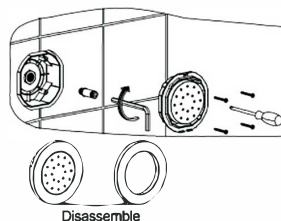
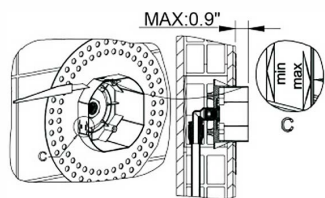
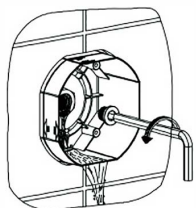

7). When installing, please install according to the upper and lower signs, and the cover plate opening is facing down;

8). The opening of the cover plate faces down to facilitate later maintenance;

9). Install shower arm and shower head (wrap the PTFE tape on the thread).

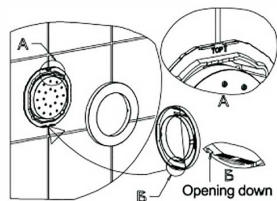

BEFORE INSTALLATION

NO.	Item	Qty
1	Shower Head Cover Plate	1
2	Shower Head Outlet Pipe	1
3	Shower Head	1
4	Three-Function Embedded Box	1
5	Plate	1
6	Diverter Cap	1
7	Switch Handle	1
8	Cover Plate	1
9	Fixed Seat	2
10	Lifting Lever	1
11	Hand Shower Bracket	1
12	Shower Hose	1
13	Hand Shower	1
14	Installation Cover	3
15	Embedded Seat	3
16	Cover Plate	3
17	Spray Body	3
18	Mounting Pad	1
19	Connecting Rod	3
20	Gasket	3
21	Connector	3
22	Plug	3
23	Side Spray Screw Accessory Bag	1
24	Handle Accessory Bag	1
25	Manual	1
26	Screw Accessory Bag	1

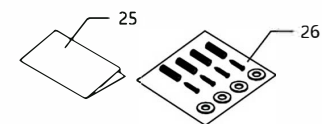
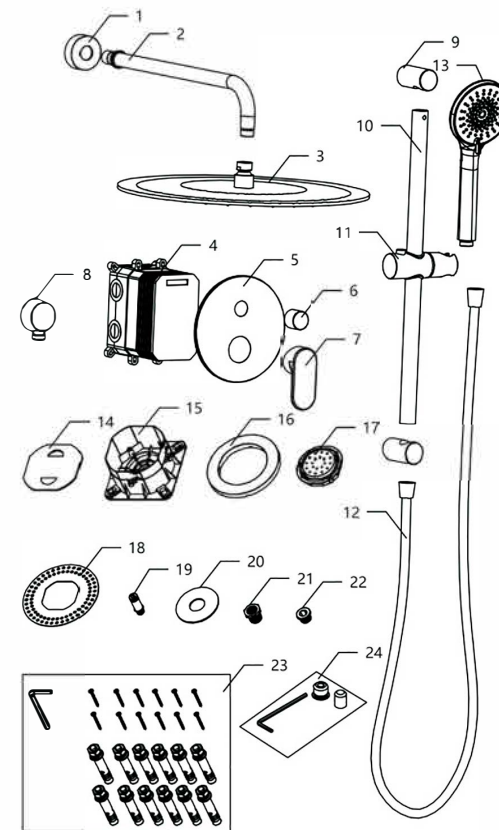

Check accessories

Standard List of Accessories:

When you open the product packaging, please check whether the objects in it are consistent with the main body and accessories you purchased. If there is any inconsistency, please contact our company or our distributor.

Note: 1. Accessories are subject to change without prior notice if the change does not affect usage;

2. The appearance of the product is subject to the physical objects you receive, and the schematic diagram is only for reference.

INSTALLATION STEPS

Cna. Solid wall installation

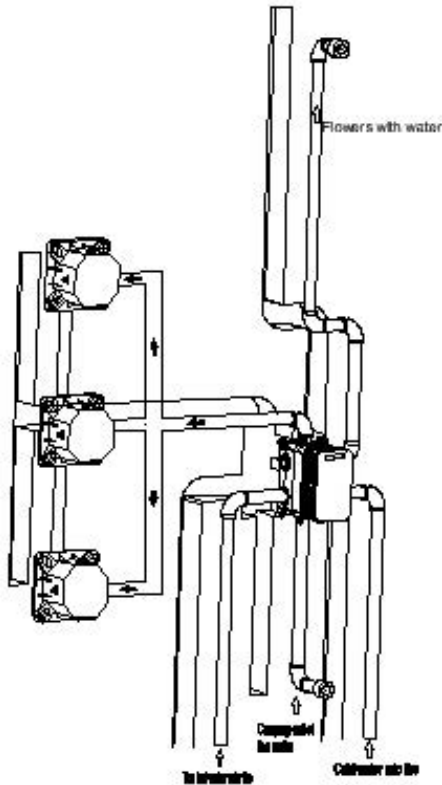
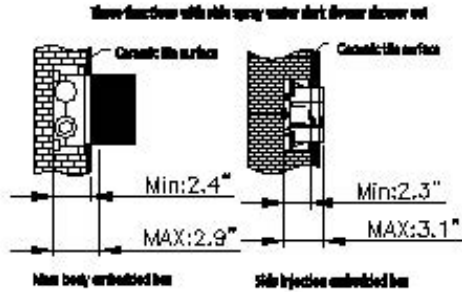

1. According to the basic size of the embedded box, use special tools to open the main hole on the solid wall. The depth of the hole is shown in the figure. Then the blank wall in the hole depth should choose the main body buried box distance between 1.8"~2.1", the top spray buried box distance between 1.5"~2.3";

2. the size of the hole with the embedded box for convenient installation principle;

3. The bottom surface of the opening hole should be kept smooth for subsequent adjustment of the vertical and horizontal of the embedded box;

4. According to the three functions of the embedded box connection pipeline, pay attention to the left and right directions of the embedded box. The left side is connected with hot water pipeline, the right side is connected with cold water pipeline, and the upper, lower and right side is connected with mixed water outlet pipeline; Side spray spray embedded box connection pipeline, pay attention to the bottom of the embedded box water;

5. After the pipeline is connected, according to the pipeline layout, the corresponding pipe groove is opened on the blank wall;

6. Before the embedded box is fixed, water test and pipeline cleaning shall be carried out on the embedded box and the connecting pipe, and the upper mixed outlet channel shall be in the open state before the test;

7. Before the test, open the switch spool and open the water source to test whether the left and right water inlet pipes are closely connected without leakage. After the water inlet pipe is tested and closed, adjust the flow switch to open to test whether the upper mixed water outlet pipe is closely connected without leakage; At the same time, maintain a period of time to clean the management of foreign matter to prevent affecting the control valve outlet function;

8. Fix the embedded box on the wall according to the tapping screw in the solid wall of the embedded box;

11. Confirm again that the pipeline connection is correct and there is no leakage in the water test. After the installation of other embedded components of the shower, seal and fix the embedded box and pipeline with filler;

12. At this point, the solid wall embedded box is installed, and the subsequent control valve can be installed after the wall is laid.

⚠ Note: seal the wall after the pipe is connected correctly without leakage.

INSTALLATION STEPS

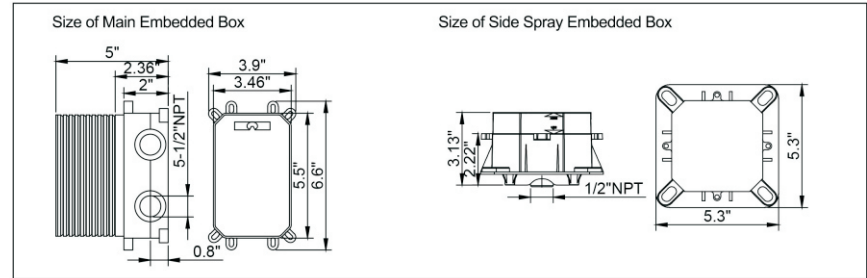

2. Installation steps of valve body

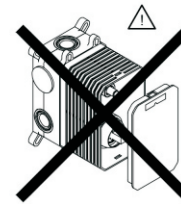

NOTE:

- ① Do not leave the embedded box in an open state when laying the wall, so as not to affect the function of the embedded box and the installation of the control valve after the solidification of the filling in the box;
- ② The built-in 0.16" hexagonal sheet metal hand is placed in the box after the embedded box is installed, so as not to lose it and affect the subsequent installation;
- ③ The surface of the control valve set is mostly electroplated and smooth. It should be stored in the original packaging before installation to prevent scratches, corrosion and loss.

1). Lay wall tiles or other decorative wall, keep the wall level and 90° perpendicular to the embedded box, make the embedded box in the middle of a single tile as far as possible, and cut off the protruding part of the embedded box with a cutting knife;

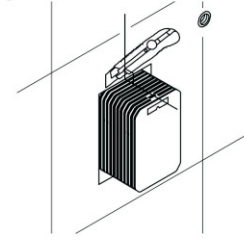

3). Install the control valve plate, check whether the protective rubber sleeve at the plate hole is off before installation, if there is no protective rubber sleeve, directly install the plate that is easy to scratch;

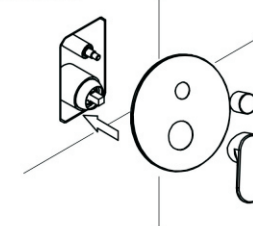

2). Remove the embedded box cover plate and the water testing assembly.

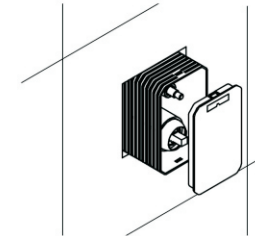

4). Install the switch handle, use a small hexagon wrench clockwise to fix the switch handle on the main valve core of the control valve, and install the decorative cap;

