

Corner Curio Cabinet (Flower)

Item: YL-009

Assembly Instructions

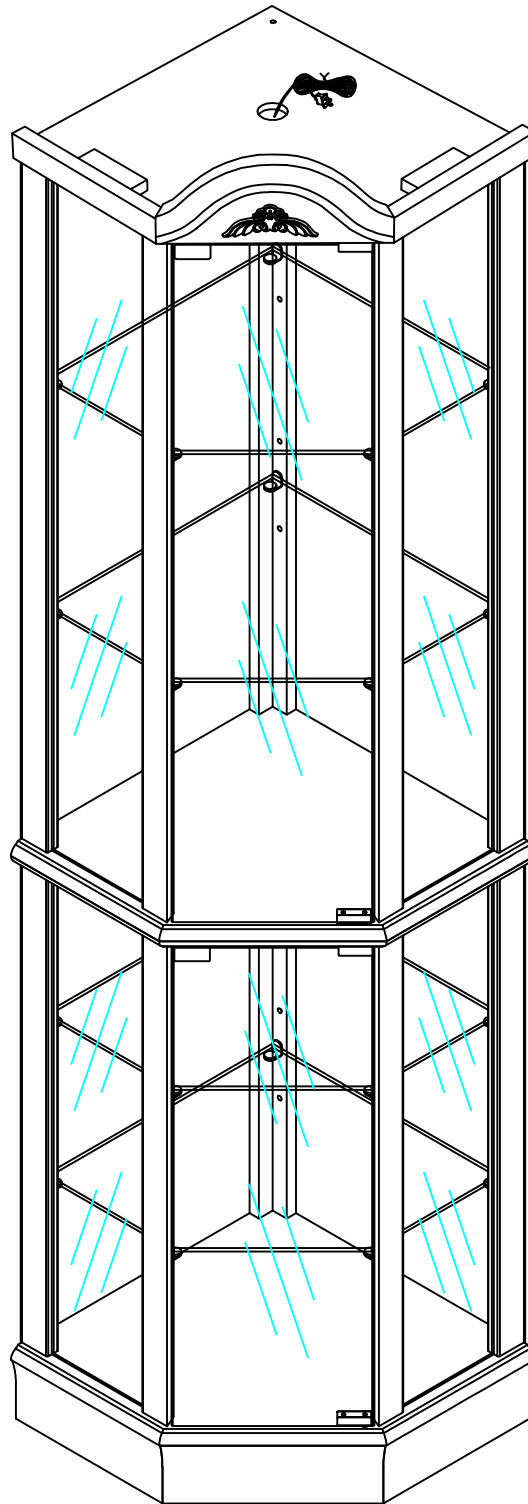

ASSEMBLY TOOLS REQUIRED (NOT INCLUDED)

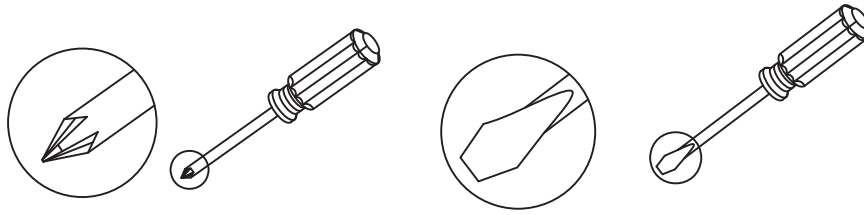

WOODEN DOWEL INSTALLATION PROCEDURE

- (1) FILL HOLE 1/4 FULL OF GLUE.
- (2) GENTLY TAP DOWEL INTO HOLE WITH RUBBER MALLET OR USE HAND PRESS IN.
DO NOT USE HAMMER
- (3) WIPE AWAY EXCESS GLUE.

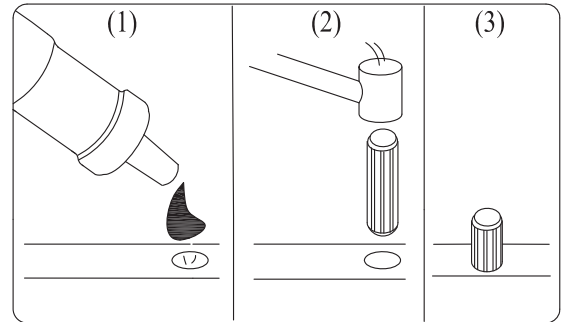

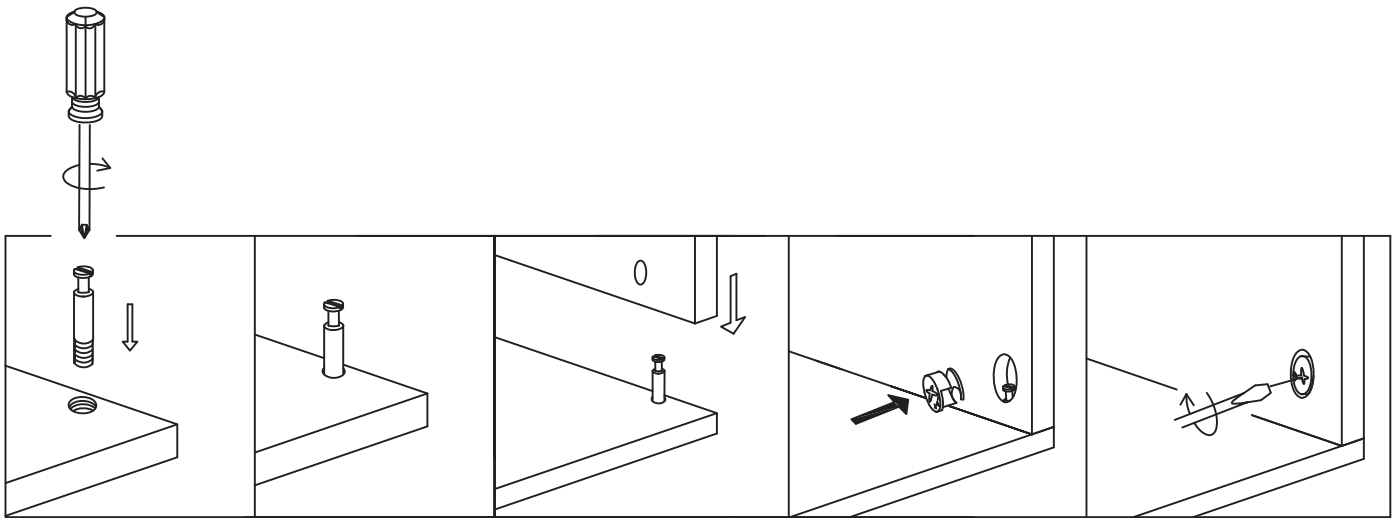

HIDDEN CONNECTOR.....ASSEMBLY TECHNIQUES



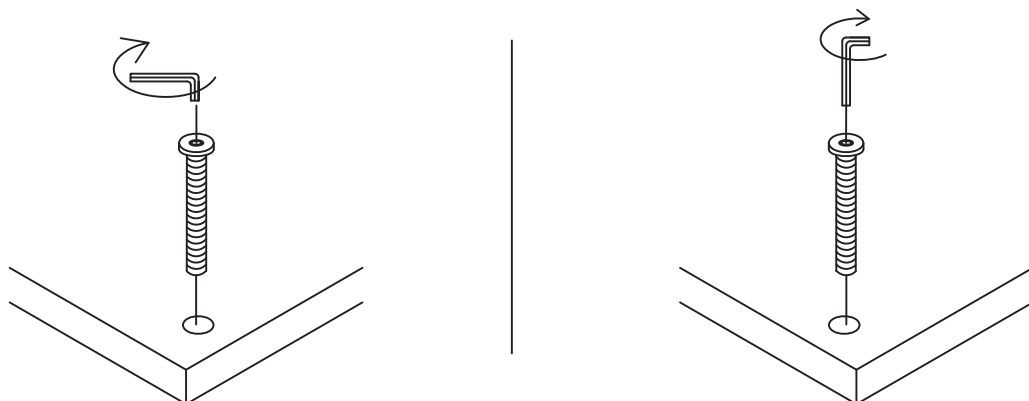



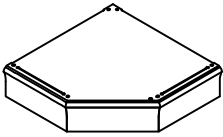
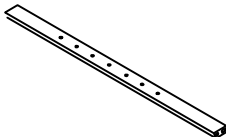
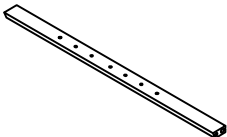
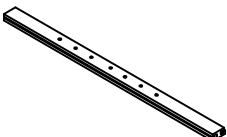
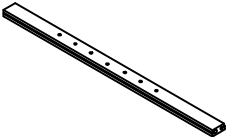
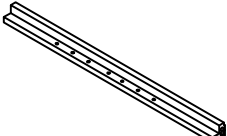
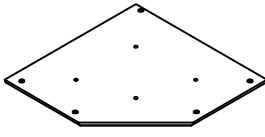
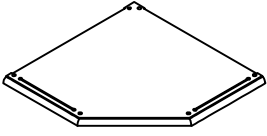
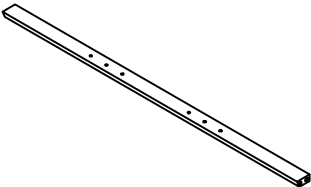
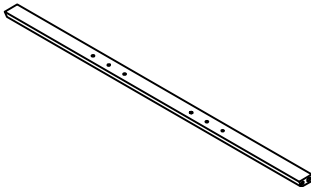
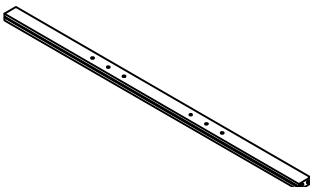
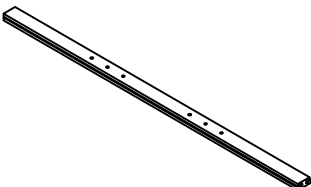
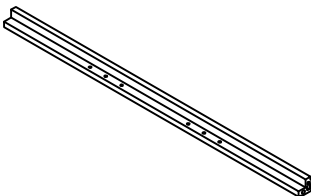
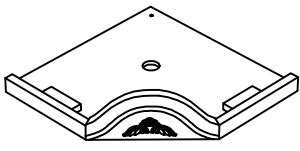

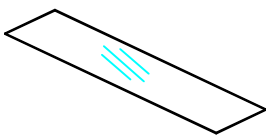
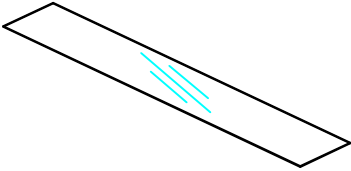
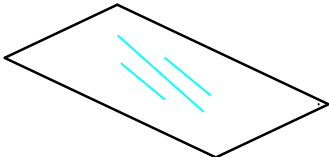
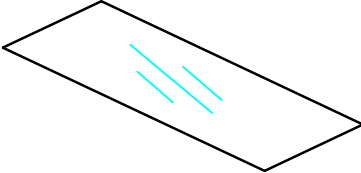
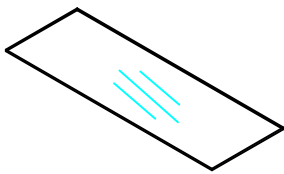
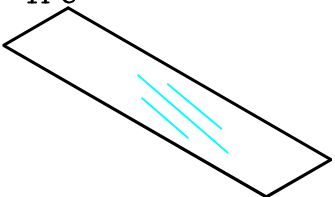
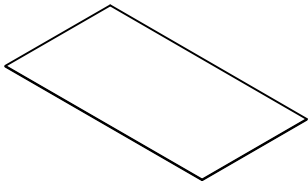
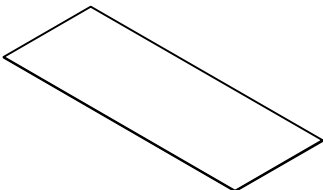





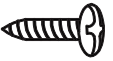
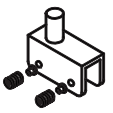
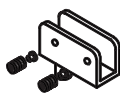

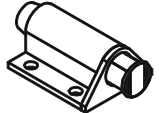

MACHINE SCREW INSTALLATION PROCEDURE





Parts List

<p>1: Bottom Frame -1Pc</p> 	<p>2: Lower Left Front Corsspiece -1Pc</p> 	<p>3: Lower Right Front Corsspiece -1Pc</p> 	<p>4: Lower Left Back Corsspiece -1Pc</p> 
<p>5: Lower Right Back Corsspiece -1Pc</p> 	<p>6: Lower Back Pole -1Pc</p> 	<p>7: Lower Top Panel -1Pc</p> 	<p>8: Upper Bottom Panel -1Pc</p> 
<p>9: Upper Left Front Crosspiece -1Pc</p> 	<p>10: Upper Right Front Crosspiece -1Pc</p> 	<p>11: Upper Left Back Crosspiece -1Pc</p> 	<p>12: Upper Right Crosspiece -1Pc</p> 
<p>13: Upper Back Pole -1Pc</p> 	<p>14: Upper Top Frame -1Pc</p> 	<p>15: Glass Shelves -4Pcs</p> 	<p>16: Lower Side Glass -2Pcs</p> 
<p>17: Upper Side Glass -2Pcs</p> 	<p>18: Lower Back Mirror -2Pcs</p> 	<p>19: Upper Back Mirror -2Pcs</p> 	<p>20: Lower Door Glass -1Pc</p> 
<p>21: Upper Door Glass -1Pc</p> 	<p>22: Lower Back Panel -2Pcs</p> 	<p>23: Upper Back Panel -2Pcs</p> 	

Hardware List

A: Machine Screw 20Pcs  $\phi 1/4" \times 1 1/8"$	B: Wood Dowel 20Pcs  $\phi 8 \times 30 \text{mm}$	C: Flat head Screw 2Pcs  $\phi 3 \times 12 \text{mm}$	D: Round Head Screw 68Pcs  $\phi 3 \times 12 \text{mm}$	E: Door Clip A 2Sets 
F: Door Clip B 2Sets 	G: Metal Clip 2Sets 	H: Magnet 2Pcs 	I: Shelf Support 20Pcs 	J: Banana Lamp 1Pc 
K: Wood Dowel 2Pcs  $\phi 8 \times 20 \text{mm}$	L: Machine Screw 2Pcs  $\phi 1/4" \times 3/4"$	M: Allen Wrench 1Pc 	N: Safety Wall Strap 2Pcs 	O: Plastic Anchor 2Pcs 
P: Mounting Screw 2Pcs  $\phi 4 \times 38 \text{mm}$	Q: Washer 4Pcs 	R: Lamp Bulb 1Pc  120V 4W Type T Bulb	S: Glue 1Pc 	



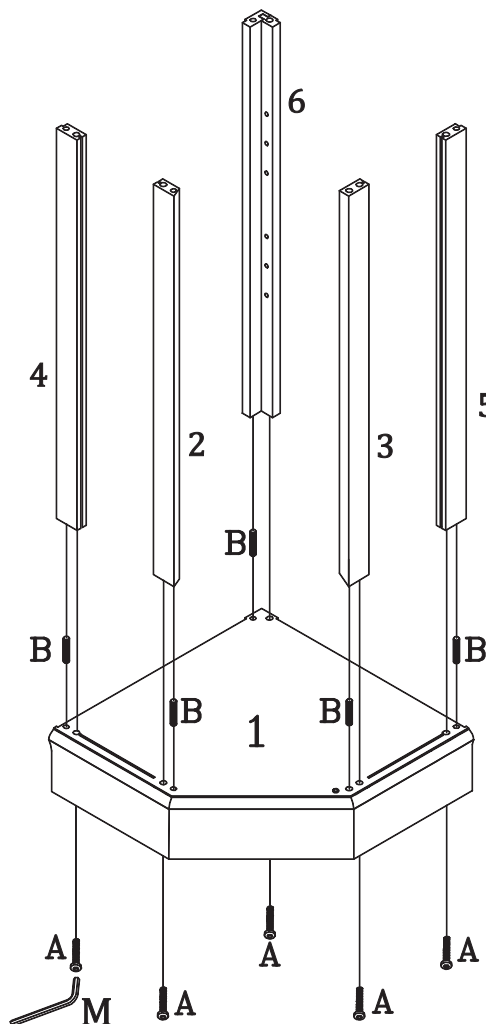

STEP 1

A		5
B		5
M		1

Put the bottom frame on a worktable in horizontal, keep the crosspieces stand on the base, then to assemble it.



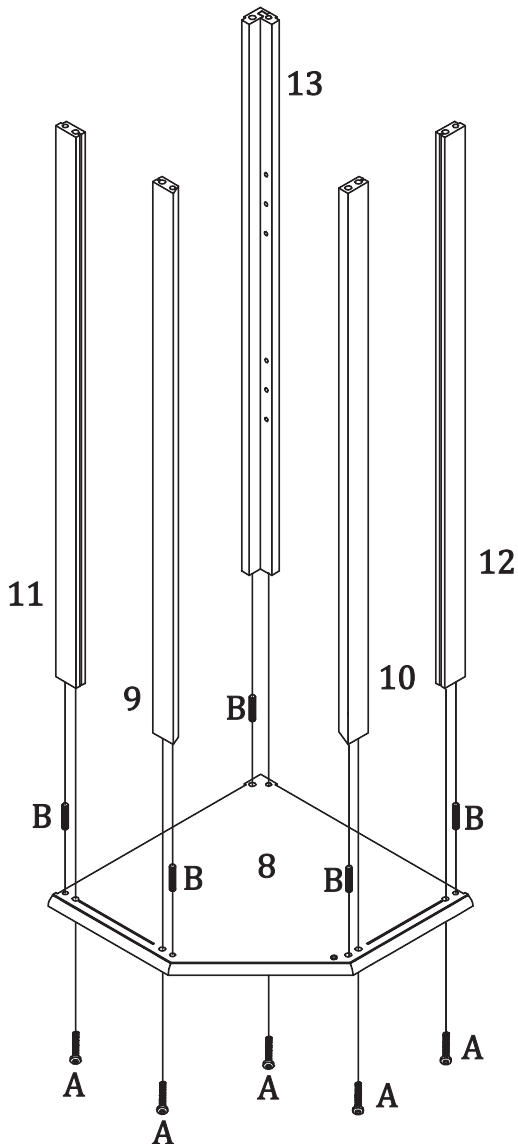
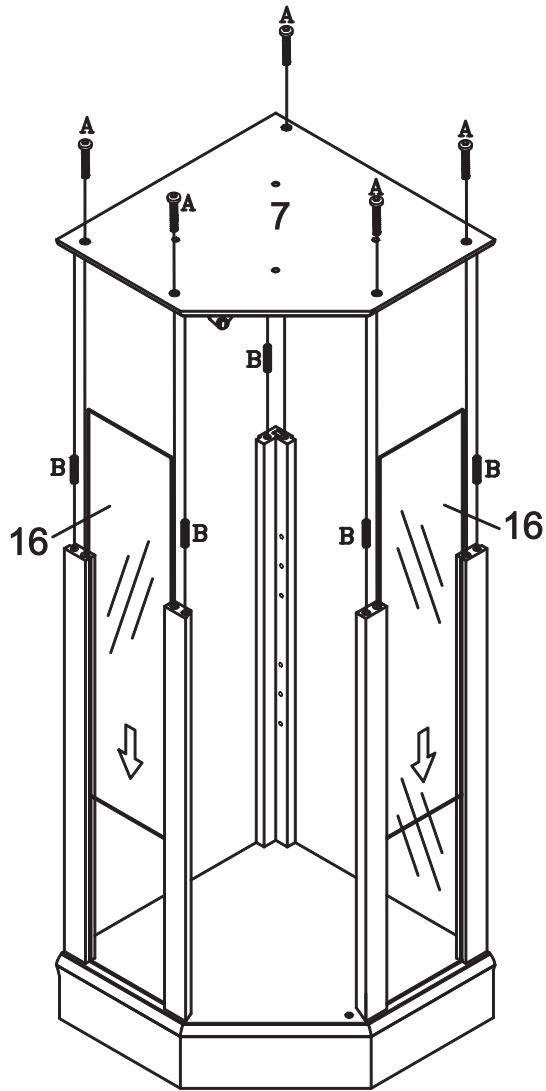
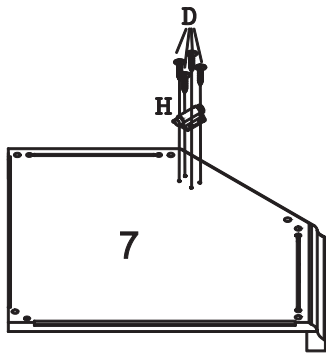

STEP 2

A		5
B		5
D		4
H		1









STEP 3

A		5
B		5



Put the upper bottom panel on a worktable in horizontal, keep the crosspieces stand on the base, then to assemble it.

STEP 4

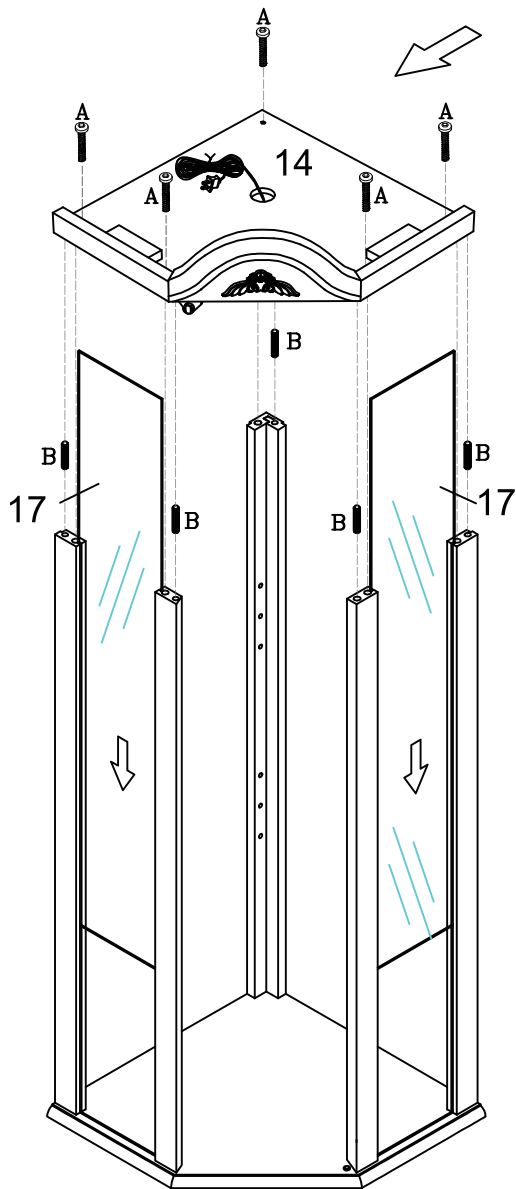
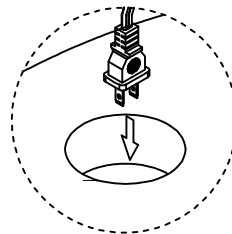
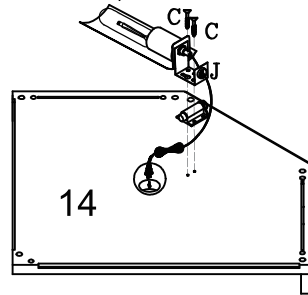
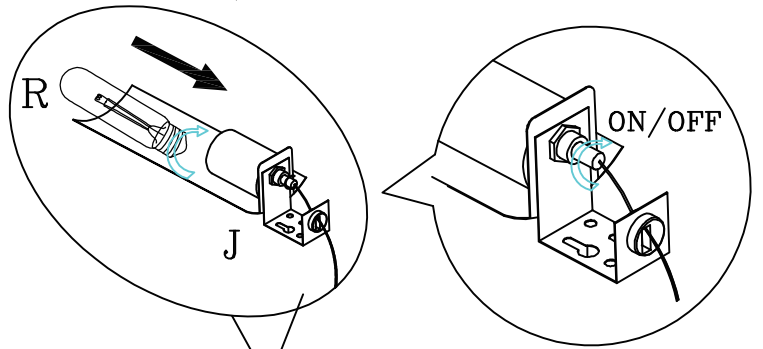
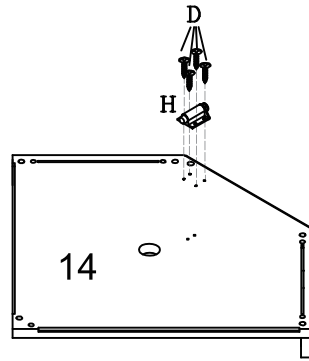
A		5
B		5
C		2
D		4
H		1
J		1
R		1



STEP 5

D		32
N		2
Q		2

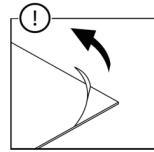
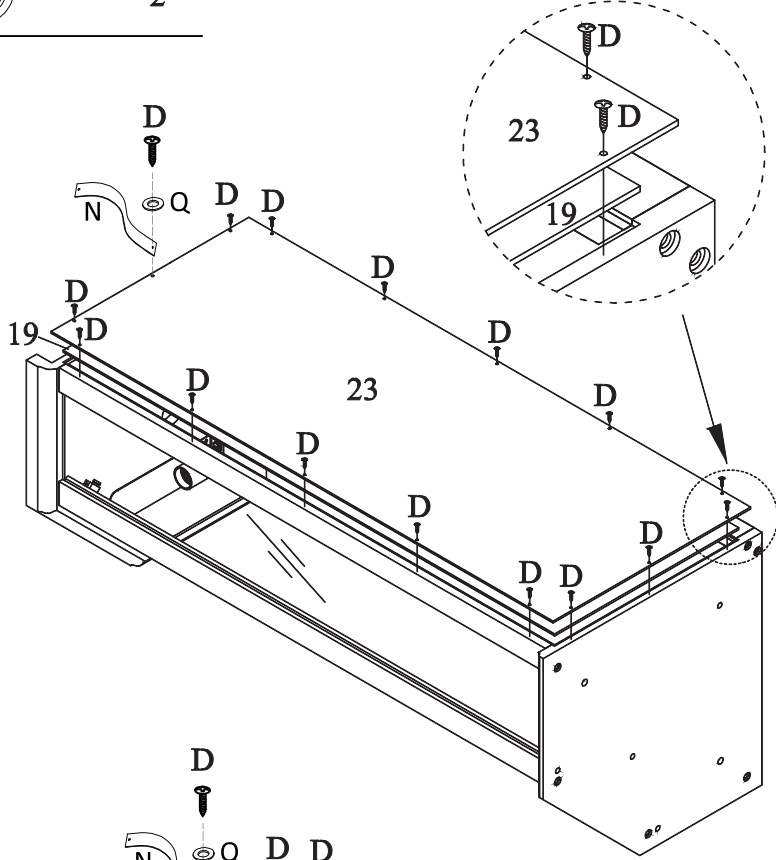

Remove protective film on the mirror panel.
 Tips: First remove protective film on the #19 upper back mirror, then you can assemble with #23 upper back panel

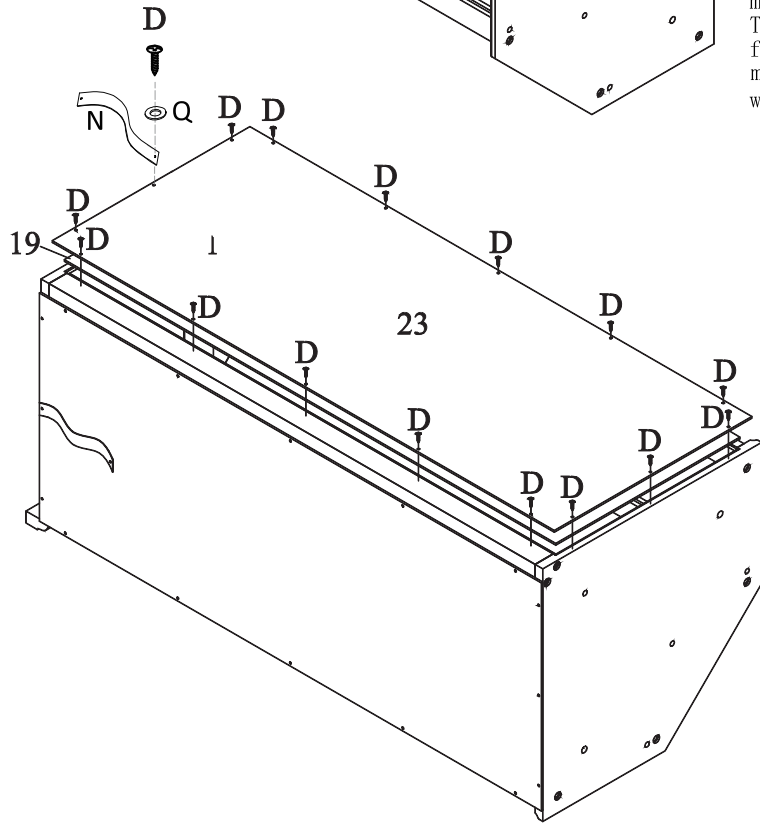

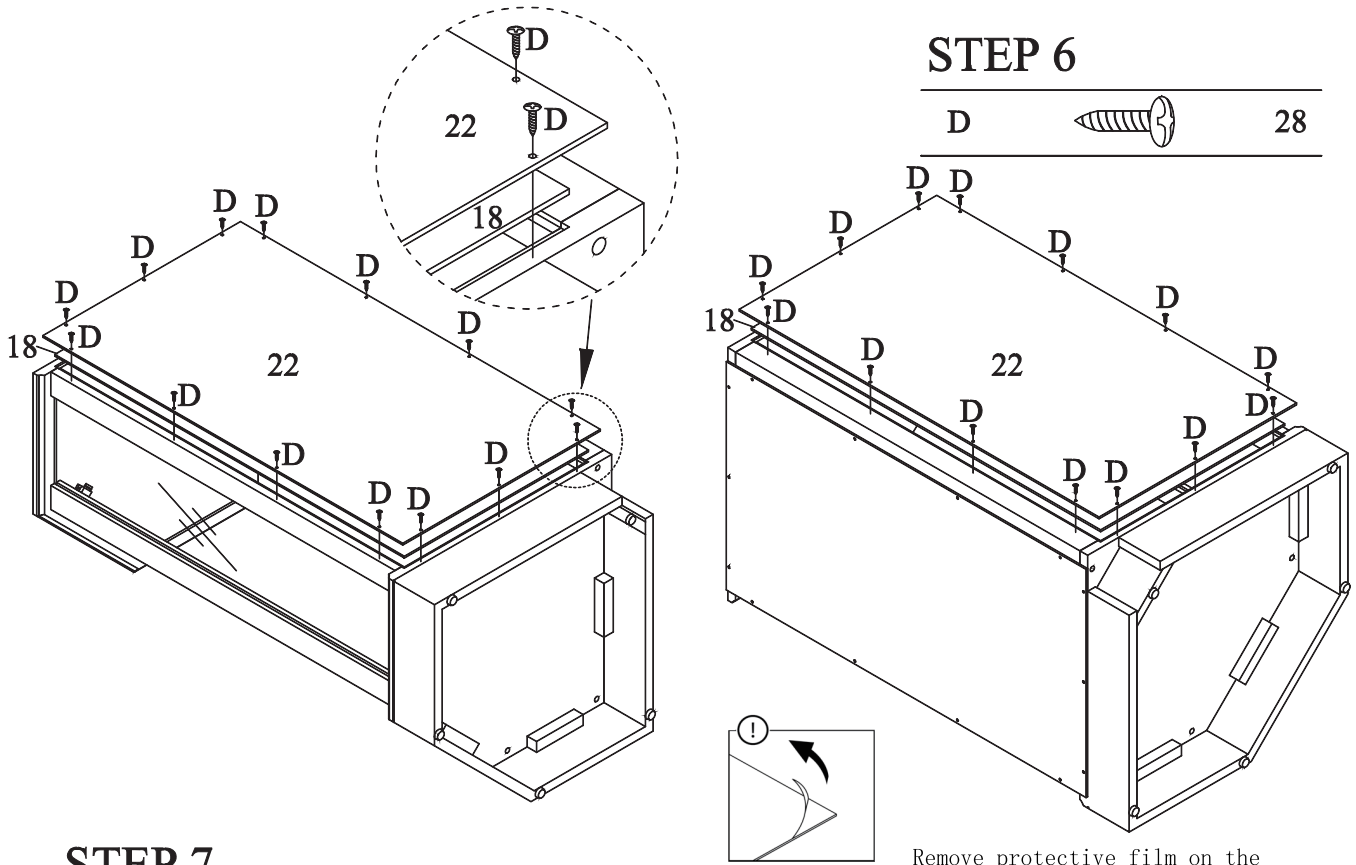

STEP 6

D		28
---	-------------------------------------------------------------------------------------	----





Remove protective film on the mirror panel.
 Tips: First remove protective film on the #18 upper back mirror, then you can assemble with #22 upper back panel

STEP 7

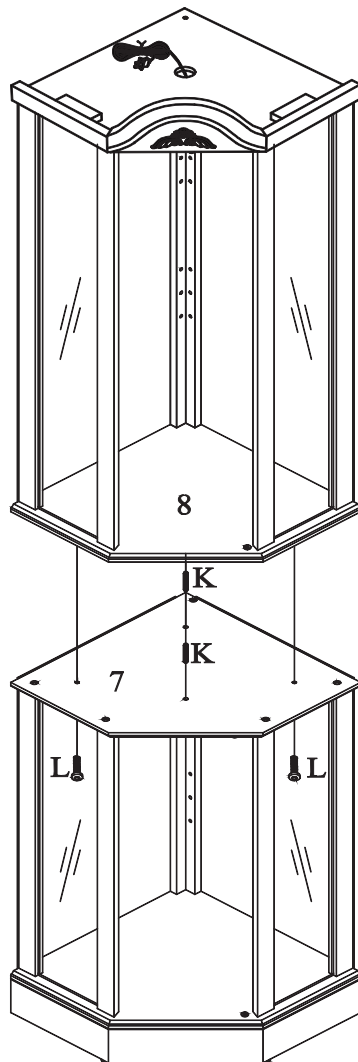
L		2
K		2



STEP 8

E		2
F		2
G		2

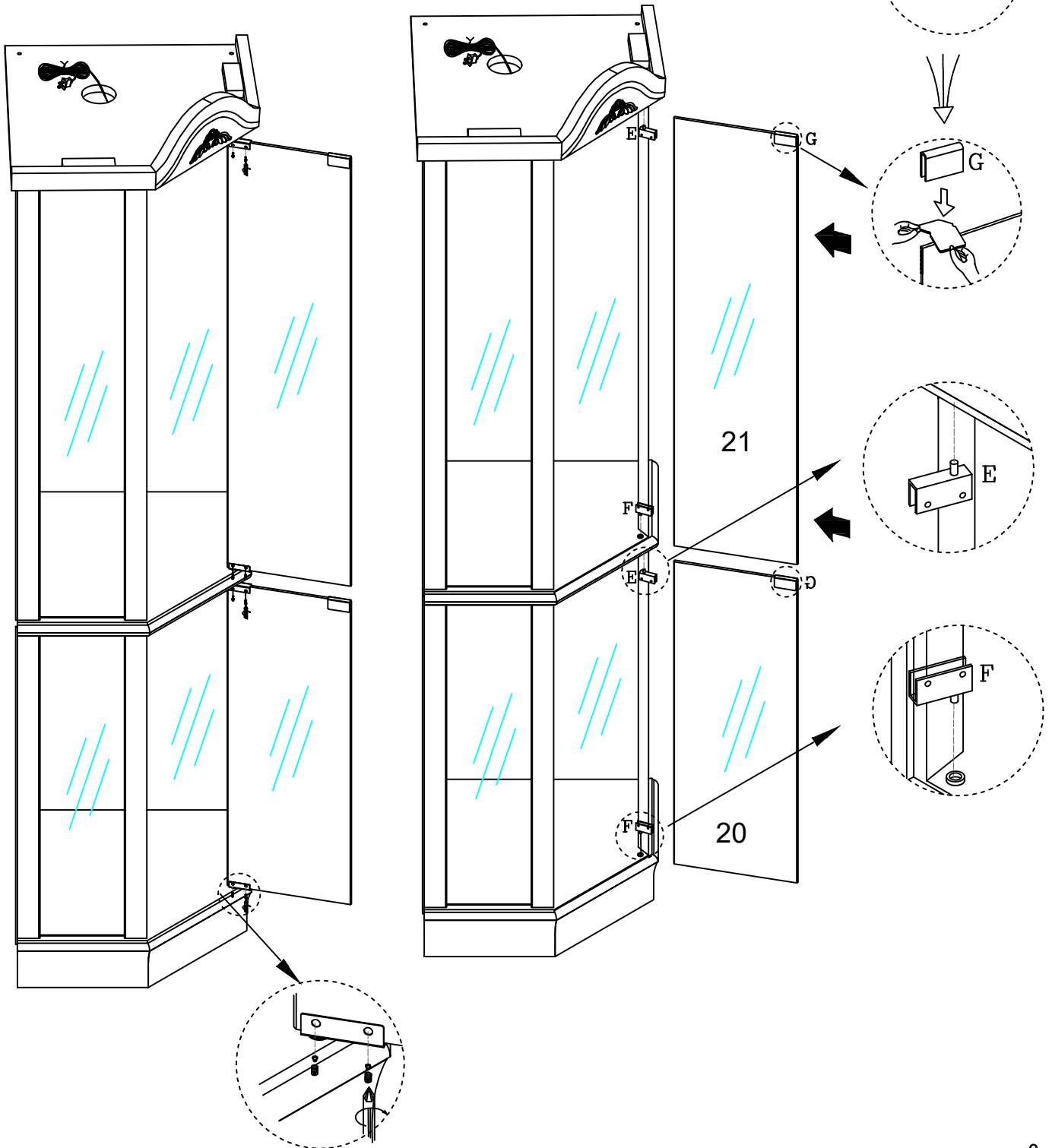

STEP 9

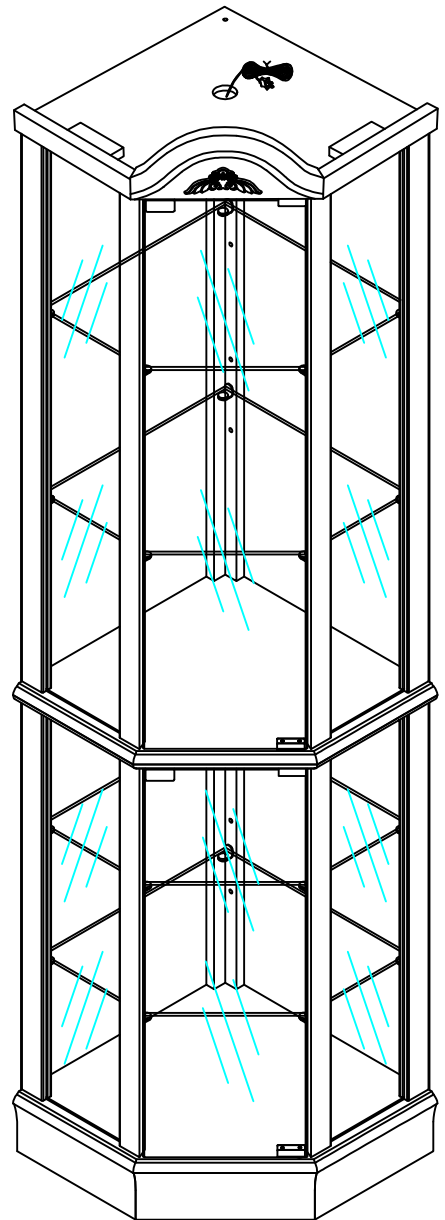
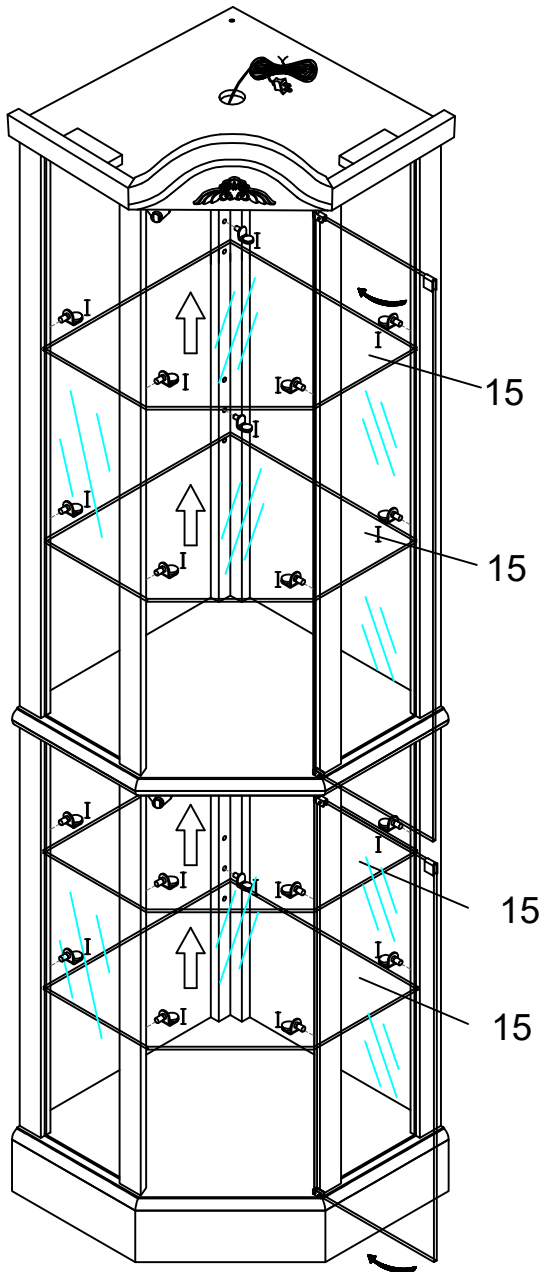

I		20
---	-----------------------------------------------------------------------------------	----

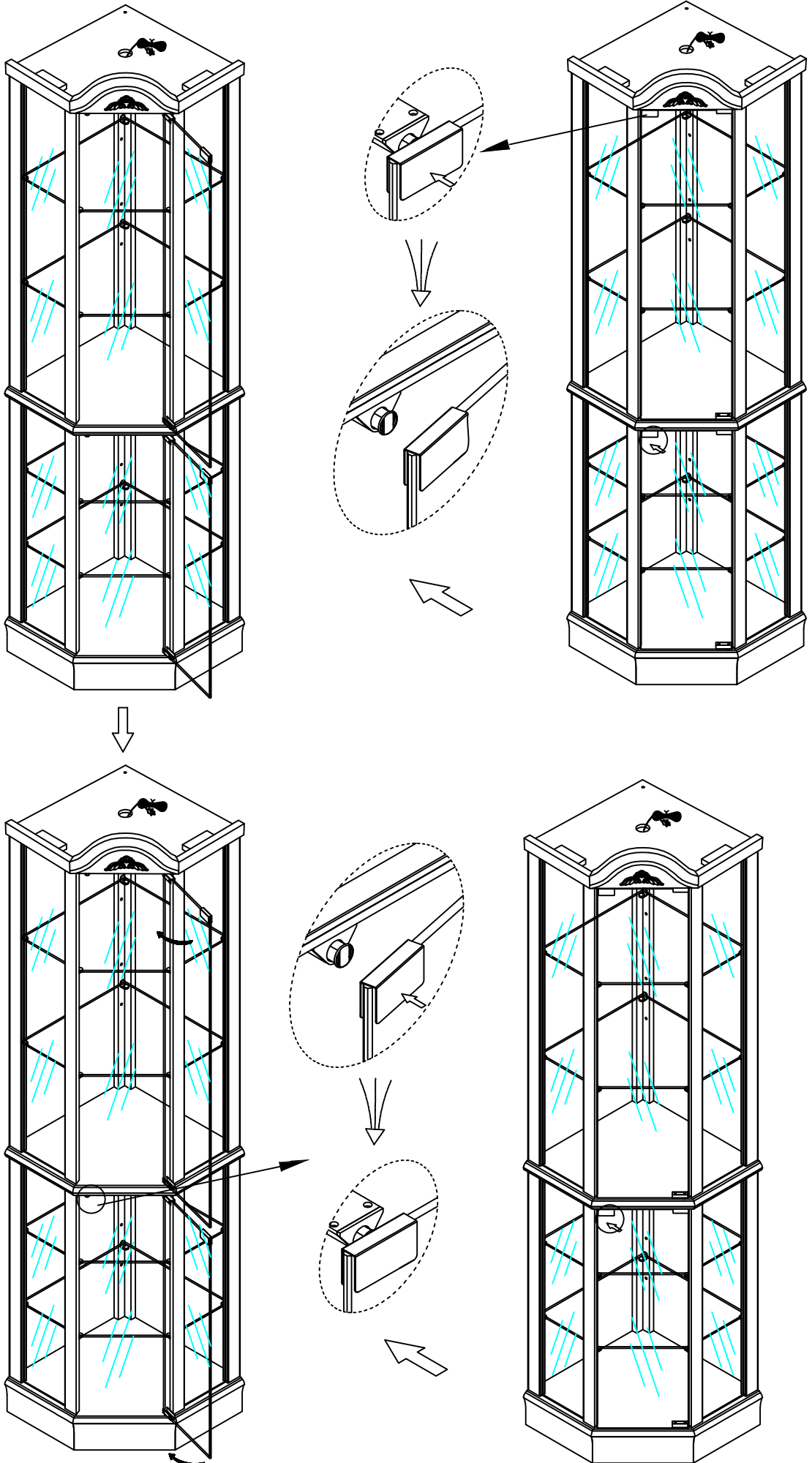

STEP 10



STEP 11

O		2
P		2
Q		2

