



I. IMPORTANT PRECAUTIONS



	MINIMUM USER HEIGHT	140 cm		MAX USER WEIGHT	90 kg.
---	---------------------------	--------	---	-----------------------	--------

To decrease the risk of suffering severe injuries, read carefully all the important instructions and warnings regarding the use of a treadmill before using it.

UMAY doesn't take any responsibility for personal injuries or property damages resulting from the use of this product.

1- Before starting any workout program, consult your doctor. It's especially important for people older than 35 years old, people with a health problem, and pregnant women.

2- The owner must ensure that all users are correctly informed about the warnings.

3- Use the equipment as explained in the instructions manual.

4- Keep the equipment in an enclosed area, away from dust or humidity. Don't store it in a garage, indoor backyard, or near the water. Humidity, dust, and water could lead to a malfunction of the equipment, annulling its guarantee.

5- Place the unit on a flat surface. If the surface is uneven, the proper functioning could be affected. Some models include leveler or leveling threads behind the legs, helping the leveling. Please read the manual to verify if your unit is provided with one of them.

6- The unit must be placed in a ventilated area. Don't use it in places with sprays or with oxygen dispensers. The air you breathe may be affected and cause an accident.

7- Keep children younger than 12 years old and pets away from the equipment. Keep the security distance.

8- Check in the manual the maximum weight your equipment can support. Excessive weight could lead to a malfunction in the operating system, which won't be covered by the guarantee.

9- Wear suitable clothes and shoes. Do not use loose clothing that may get hooked.

10- If your equipment is working through a power supply: make sure that the power cord and plug are in good condition. Carry out the connection only when the circuit has ground connection, otherwise, it could cause damages on the equipment or in the property which the guarantee won't cover. Power cords must be away from hot surfaces.

- 11- If it is a battery-powered unit: check and make sure that they are charged enough so the display will fully function.
- 12- If your unit works thanks to a power supply: don't put it into operation while you are on the belt. The motor would be unnecessary loaded. The right way is placing yourself with open legs, each one on a side of the belt, and sit up once it is ongoing.
- 13- If your unit works with an electric supply: check the speed it can reach, for your security. The best is to adjust gradually the speed to avoid sudden changes.
- 14- Machines don't take too much space as they can be folded. Once folded, make sure that all is well assembled to the locking system, either if it has a lock or a hydraulic engine. Don't try to move it or raise unless you are insured. Should any damage happen to be the machine uninsured, it won't be covered by the guarantee.
- 15- Check and tighten all screws regularly, because due to vibrations screws and nuts tend to loosen. Damages caused by a lack of maintenance won't be covered by the guarantee.**
- 16- A correct lubrication of the treadmill with silicon oil or Teflon is IMPORTANT.**
- 17- Two people will be needed to take the unit from the package. Otherwise, the damages caused at this moment won't be covered by the guarantee.**
- 18- Do not let any object fall into the grooves.
- 19- If the unit works through a power cord: unplug always the power cord before cleaning it, after the workout, and before performing any maintenance duty.
- 20- This unit is designed for a domestic purpose and in an interior place, not for a business environment or outside.
- 21- Do a workout with stretches before and after the sessions, you will avoid injuries.
- 22- Drink water before, during, and after the workout.
- 23- If you start feeling pain or dizziness while training: **STOP IMMEDIATELY.**
- 24- You must preserve the original packaging with its protections, manuals, and components during the guarantee period.**
- 25- The accessories can be different from the other models.
- 26- This electronic product can't be thrown under any circumstances into the municipal rubbish bins. To preserve the environment, this product must be recycled according to the applicable law of your country. Please contact your town council to know more about this procedure.
- 27- Should you need technical assistance or advice with the installation of pieces, You can get in touch with us by email :umay1123@outlook.com or you can call us: +1 626-416-8618.

YOU MUST KEEP THE PURCHASE RECEIPT to HAVE ACCESS TO THIS SERVICE

KEEP THESE ADVISE FOR FUTURE REFERENCES

II. MAIN TECHNICAL FEATURES

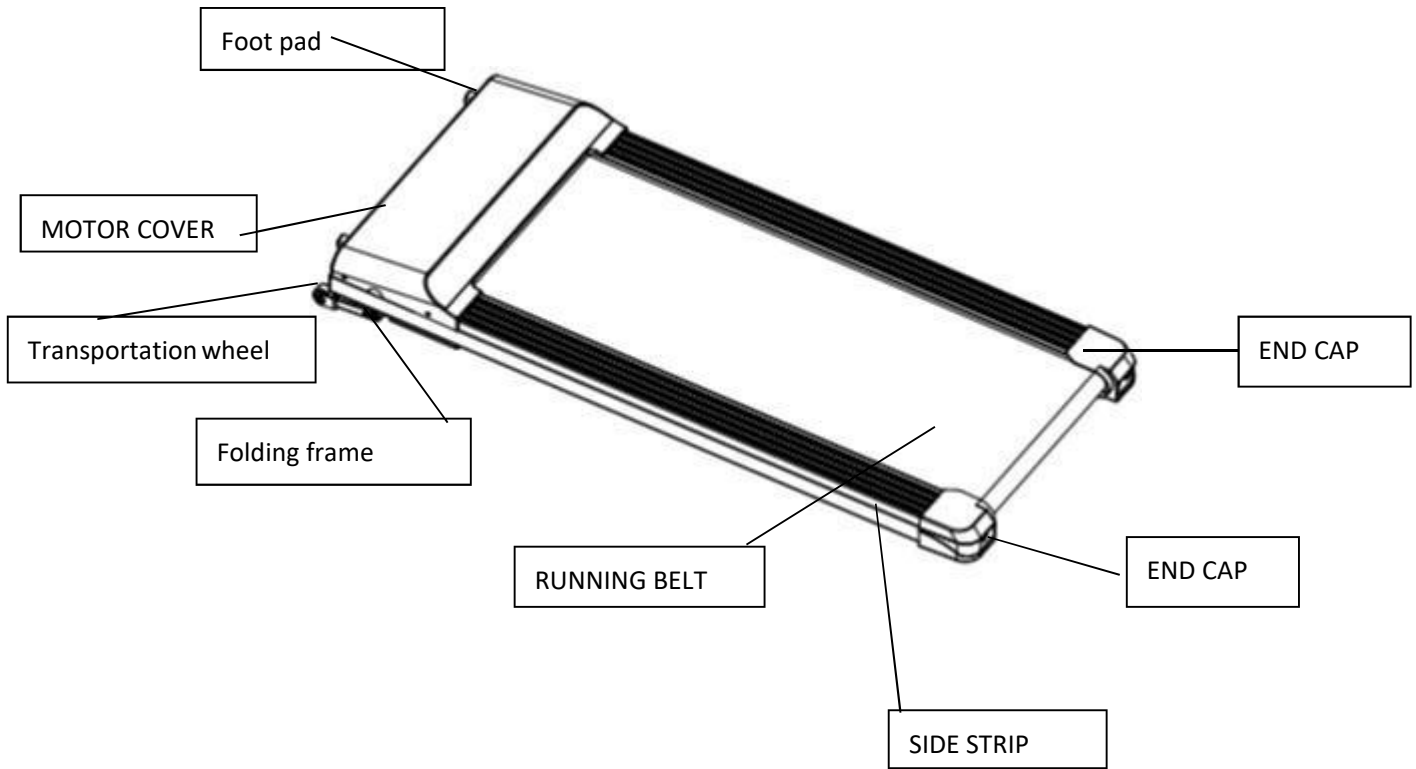





Input Voltage	110V±10%
Frequency	50/60 HZ
Running area	1050*410mm
Function	Time, Speed, Distance, Calories and remote controller
Speed Range	1.0-6.0KM/H(0-4MPH)
Max user weight	90kgs/198lbs
Power	1.5HP

III. ASSEMBLY



NOTICE:ASSEMBLY REQUIRES TWO PERSONS

No.	Fittings	Qty
1	remote controller	1
2	Silicone oil 	1
3	5mm wrench 	1
4	6mm wrench 	1
5	Multi- wrench 	1

STEP 1

1. Carry out the machine from the package by two persons and place it lightly on flat floor, and put other fittings beside the machine.
2. Plug in the power and turn on the switch(in front of your treadmill). Press the start key and stop key on the controller to check if the machine can work well.



STEP 2

When not use the treadmill, please fold the machine in direction of arrow A until the transportation wheels pop up in direction of arrow B

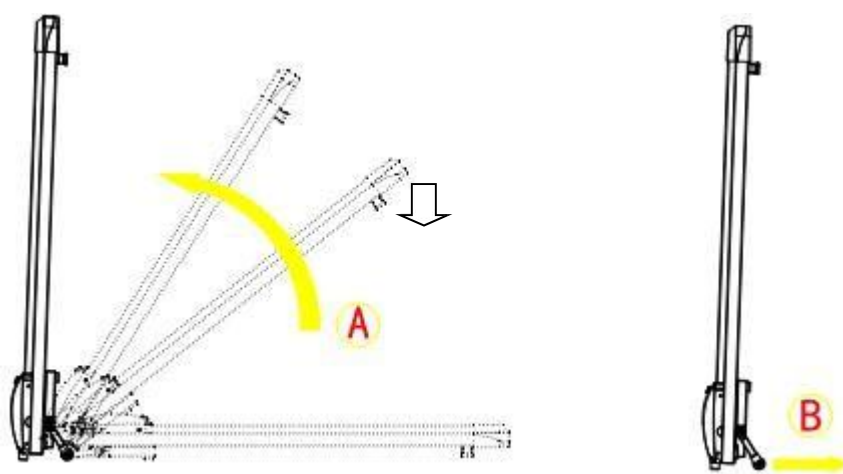

IV. SPAX INSTRUCTIONJN

Remarks: the Android system need above 5.1.1 version.

Download: Search and download "SPAX" from Apple Store / Google Play Store

Android download:

<https://play.google.com/store/apps/details?id=com.onespax.int.spax>

IOS download:

<https://apps.apple.com/us/app/spax/id1545365744>

A. Open SPAX app to log in and register by
email

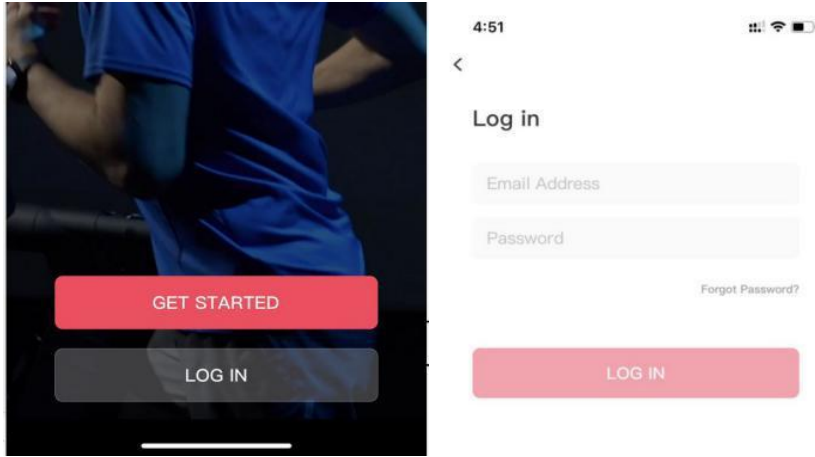

B. Turn on Bluetooth, search the device.

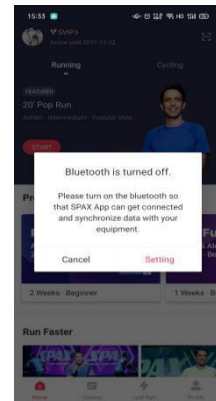

C. Select the third button below, click "JUST RUN", and then click "JOIN".

Start your treadmill.

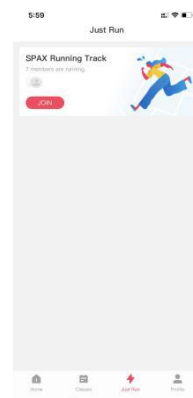

D. Class selection: According to your needs, choose running, cycling or competitive run

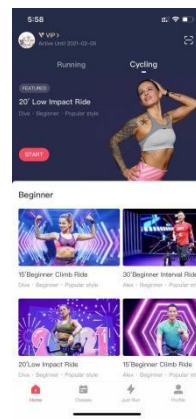
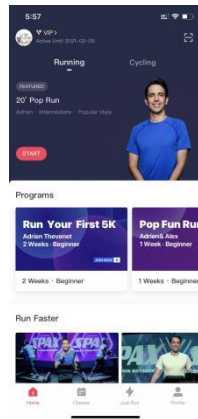

E. You can use the SPAX for three months for free. Enter the password “Umay move it” to have it

V.WORKOUT GUIDELINES

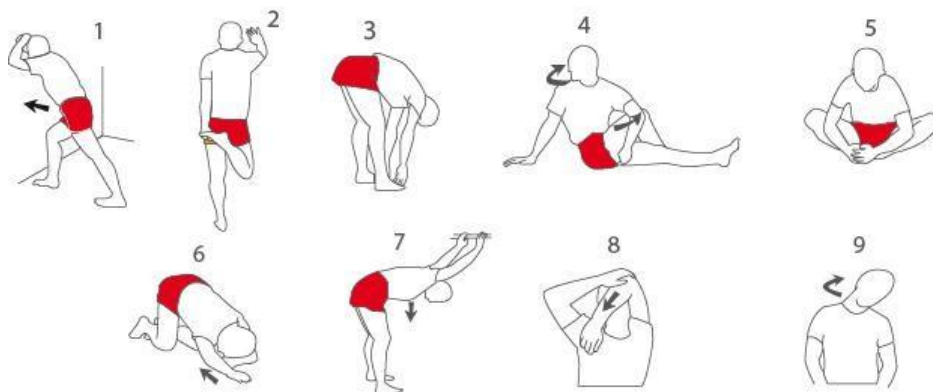

BEWARE: Before starting to use this or any exercise programs, consult your doctor. This is especially important for people older than 35 years old, or people with health problems.

PROGRAMM WITH WARM UP WORKOUTS:

Warm-up: Start stretching and slightly activating the muscles between 5 and 10 minutes. The warm-up will increase your corporal temperature, your heart rate, and your blood flow, making you ready for the workouts.

- **Workout focused on the training area:** Do some exercises during 20-30 minutes with your heart rate (don't maintain your heart rate more than 20 minutes during the first weeks of the exercise program). Breath constantly and deeply during the workout (never hold your breath).
- **Cool down:** Finish with stretching exercises during 5-10 minutes. Stretching increases the flexibility of your muscles and helps you to avoid injuries after the workouts.

FREQUENCY OF THE WORKOUT: To be fit or improve your shape, complete three workout sessions each week, with a rest day between the workouts. After some months of regular training, you will be able of completing up to five workouts a week.

VI. TREADMILL OPERATION

CONTROLLER



LED display: Speedy range 1 km- 6 km(0-4MPH)

Press “ +” key, speed will go up by 1.0km

Press “ -” key, speed will go down by1.0km

VII. MAINTENANCE

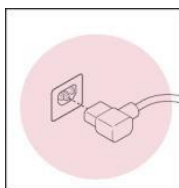

This product must be earthed. If the power cord

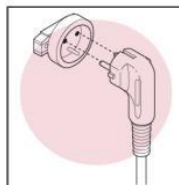

is damaged, it must be replaced with a manufacturer recommended power cord.

✗ DO NOT TANGLE THE POWER CORD

REGULAR MAINTENANCE OF THE TREADMILL

- **STORAGE:** Keep your equipment in an enclosed place, away from dust or humidity. Store it neither in a garage nor in an indoor backyard, nor near the water. Humidity, dust, and water could damage it and have an effect on its functioning
- **ELECTRIC CABLE:** Make sure that the cable and plug are in perfect conditions. Electric cables must be away from hot surfaces
- **SCREWS AND CONNECTING CABLES:** Supervise and tighten the screws on a regular basis, because due to the vibration the screws and nuts tend to loosen.

LUBRICATION:



The treadmill doesn't have a hole.

The following are some steps you need to take.

Step 1: Turn your treadmill off and unplug the power.

Step 2: Gently lift one side of the treadmill belt.

Step 3: Spray or squirt lubricant or your oil along the side of the treadmill deck.

Step 4: Lower the treadmill belt and re-tighten the treadmill belt.

Step 5: Plug the treadmill back in and turn it on.

Walk on your treadmill at a speed of 1 mph for up to five minutes. This will ensure the lubricant spreads evenly across the deck surface and reaches its center.

Lubrication Regularly:

< 3 hours/week	2 months
4 – 7 hours/week	1 month
> 8 hours/week	15 days

- **ALIGN AND TIGHTEN THE BELT OF THE TREADMILL**

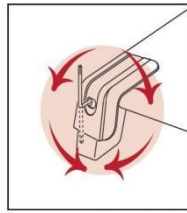

LEFT BOLT RIGHT BOLT

- **ALIGN THE BELT:** Due to its use, the belt can move off-center. If the belt has moved to the left, start treadmill and increase the speed to 3MPH. Use the 5mm Wrench to turn the fixed left bolt clockwise or turn the fixed right bolt counterclockwise. Don't tighten the belt too much in order to be able to walk. Repeat this procedure until the belt is properly aligned.

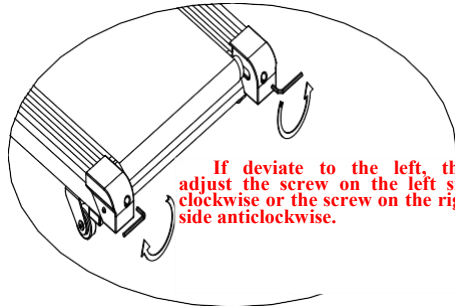

If deviate to the left, then adjust the screw on the left side clockwise or the screw on the right side anticlockwise.

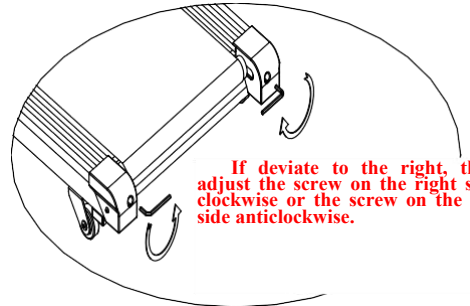

If deviate to the right, then adjust the screw on the right side clockwise or the screw on the left side anticlockwise.

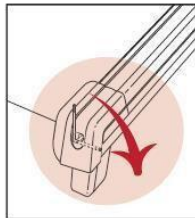
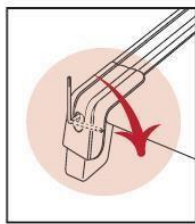

LEFT BOLT RIGHT BOLT

- **TIGHTEN THE BELT:** (if the belt slips on the treadmill when walking). Start a treadmill and increase the speed to 3MPH. Using the 5mm Wrench, turn both bolts 1/4 clockwise. If the belt is properly tight to walk, you must be able to pull up each side of the belt 5 or 7 cm off the platform. Be careful and maintain the belt aligned. Repeat this procedure until the belt is properly tightened.

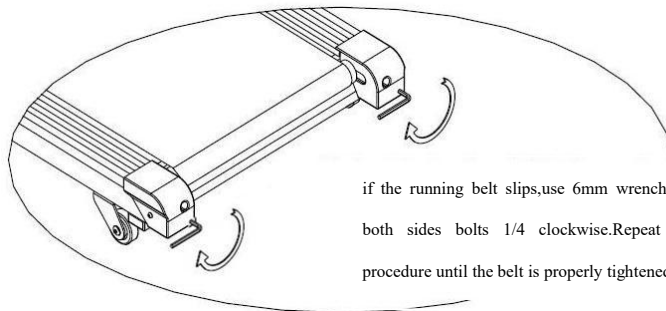

if the running belt slips,use 6mm wrench,turn both sides bolts 1/4 clockwise.Repeat this procedure until the belt is properly tightened.

- **TIGHTEN THE DRIVE BELT:** If the drive belt becomes loose after using for some time, you need to:
 - (1) Open the motor cover.

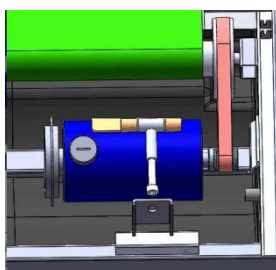

(2) Use the 5mm wrench to turn the adjusting bolt clockwise.

Repeat this procedure until the drive belt is not slippery anymore.

- **CLEANING:** Don't use abrasive products. A damp cloth is enough.
- **LEVELING:** If your unit is provided with leveling wheels, please adjust them in order to avoid vibrations and therefore malfunctions.
- **KEEP THESE MAINTENANCE ADVISES FOR FUTURE REFERENCES**

VIII. RECYCLING INFORMATION

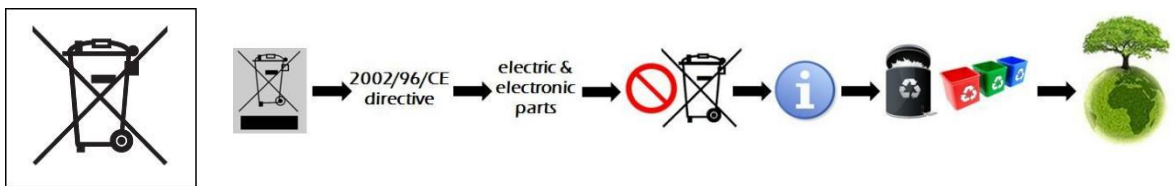

This electronic product must not be disposed of in the municipal waste. To preserve the environment, this product must be recycled after its useful life as required by law.



Correct lubrication of the treadmill with silicon oil or Teflon is IMPORTANT. This lubrication MUST BE PERFORMED REGULARLY DEPENDING ON EACH PERSON, EVEN BEFORE ITS FIRST USE.

YOU MUST PRESERVE THE ORIGINAL PACKAGING WITH ITS PROTECTIONS, PURCHASE RECEIPT, MANUAL AND COMPONENTS DURING THE GUARANTEE PERIOD

IX. WARRANTY

We have a year quality warranty for the products. Within the warranty period, we provide FREE replacement parts. If caused by incorrect assembly, incorrect use or change of parts failures, our company takes no responsibility. You should show our products series no. and relative pictures or information before getting the warranty.

This treadmill is only for home use, if the problems occurred by commercial use, our company takes no responsibility.

IF you have any problems.

please email us: umay1123@outlook.com

You can also call us: +1 626-416-8618

You can also contact us through Skype: +1 626-416-8618

you can also leave your phone number to the same email address to consult us.