

ASSEMBLY INSTRUCTION

ITEM : WF321697
Burl Cabinet w/3 doors

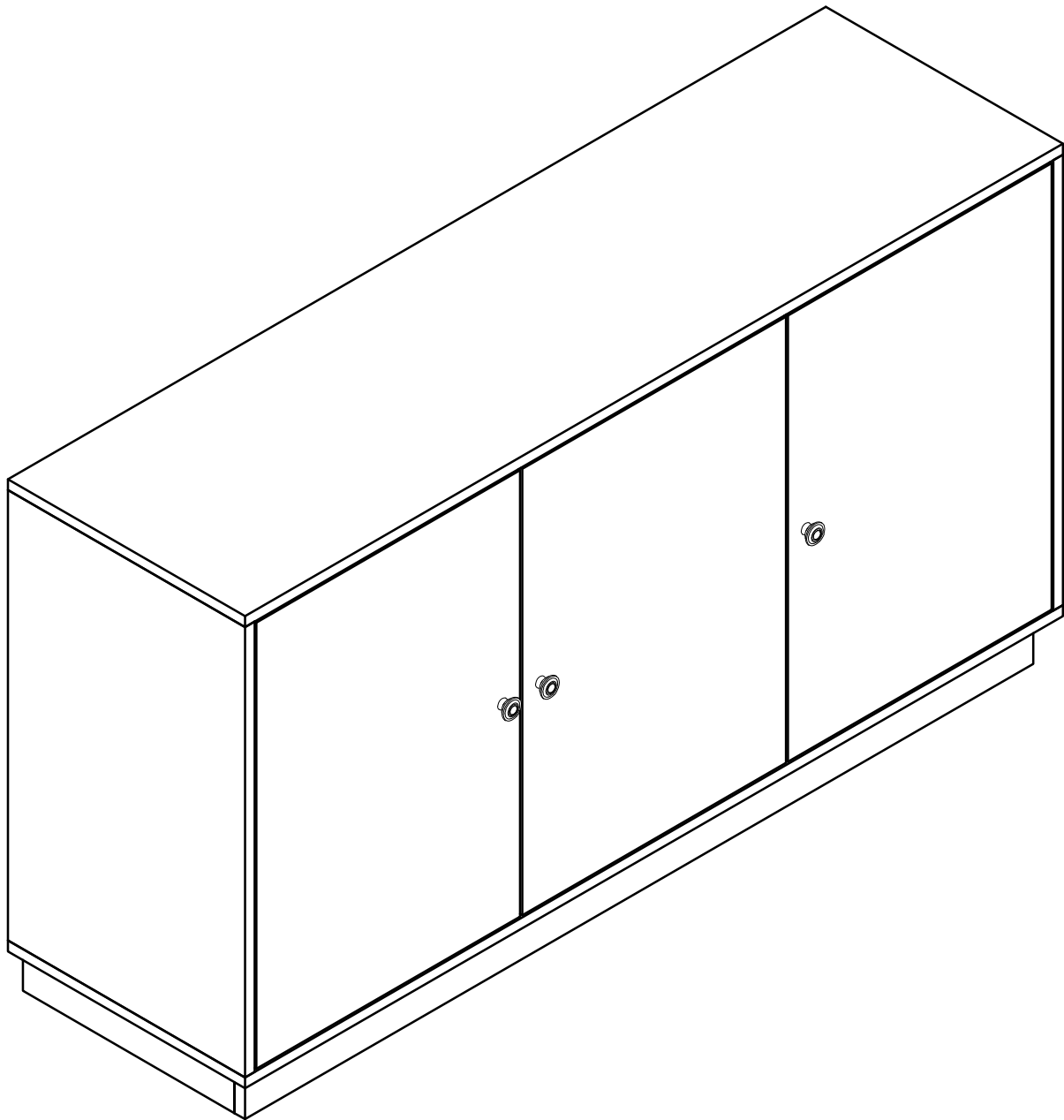

1. Thank you for choosing *our products*.

2. Return Policy







DO NOT RETURN TO THE STORE! Skip the process of returning your product and contact us directly for a replacement

If you find that parts of your order are missing or damaged, we will gladly ship any needed replacement parts free of charge.

If your product's quality does not meet your expectations or you have found any sort of defect, please contact our customer service department and let us know the details of your order and any issues encountered, we will try our best to provide you with a solution. Feel free to also directly contact our manufacturer at wftteam@comptree.net concerning needed replacement parts and they will be happy to help provide you with a solution or answer any questions you may have.

















Recommendations Before Beginning Assembly



-  • Read instructions, cover to cover
-  • Have 2-4 adults on hand for assembly [depending on product size](#)
-  • Do not assemble [directly](#) on flooring or carpet
-  • Assemble on a clean non-marring surface ([example](#): packing foam)
-  • Save all packaging until finished



3. Assembly Notice:

- If you encounter any problems during assembly and find that you cannot continue, rest assured we will help you solve the situation as soon as possible. Simply keep all of the parts of the product stored in a safe place and contact us immediately so we may assist you further.
- Once you have opened your package, remove all inner hardware packages and take the parts out. One by one, Place the parts out neatly in front of you, then refer to the instructions to ensure no parts are missing. If any pieces are found missing, please carefully look in the box first, as the hardware packaging might have torn making the hardware spill in the box.
- Some key parts of your product may be stored and hidden inside of other parts. Please open any zippered or hook & loop storage compartments to remove all parts. (example: cushions and legs being stored in the underside of a sofa)
- **IMPORTANT:** When setting up your product, **DO NOT INSTALL THE SCREWS ALL THE WAY IN THE BEGINNING.** Place each screw into their proper hole and use your hand to twist the screw halfway. Twist all the screws in halfway to ensure the holes will match up properly and the product is level on the ground. When everything seems fitted, then tighten the screws.
- When you have completed assembly, we suggest you have more than one person to assist you with lifting and placing the product.

Care & Maintenance

- 

 - Do not put hot items directly on furniture surface
- 

 - Do not clean furniture with harsh cleansers or polish
- 

 - Do not place furniture under direct sunlight
- 

 - Do not place furniture near heating or cooling vents
- 

 - Do not write on furniture without a padded barrier to protect the surface
- 

 - Do not place furniture outside. For indoor use only
- 

 - Not for commercial use. For residential use only
- 

 - Stains may be removed with mild soap solution and damp cloth

  ● Children should not climb or jump on the furniture

  ● Dust and pick-up spills using a clean, non-colored, lint-free cloth

Caution

● This product contains small components. Please ensure that they are kept away from small children.

● Do not use power tools to assemble your furniture. Power tools may strip or damage the parts.

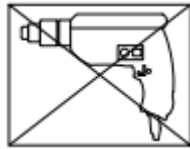

ASSEMBLY INSTRUCTION

ITEM : WF321697
Burl Cabinet w/3 doors

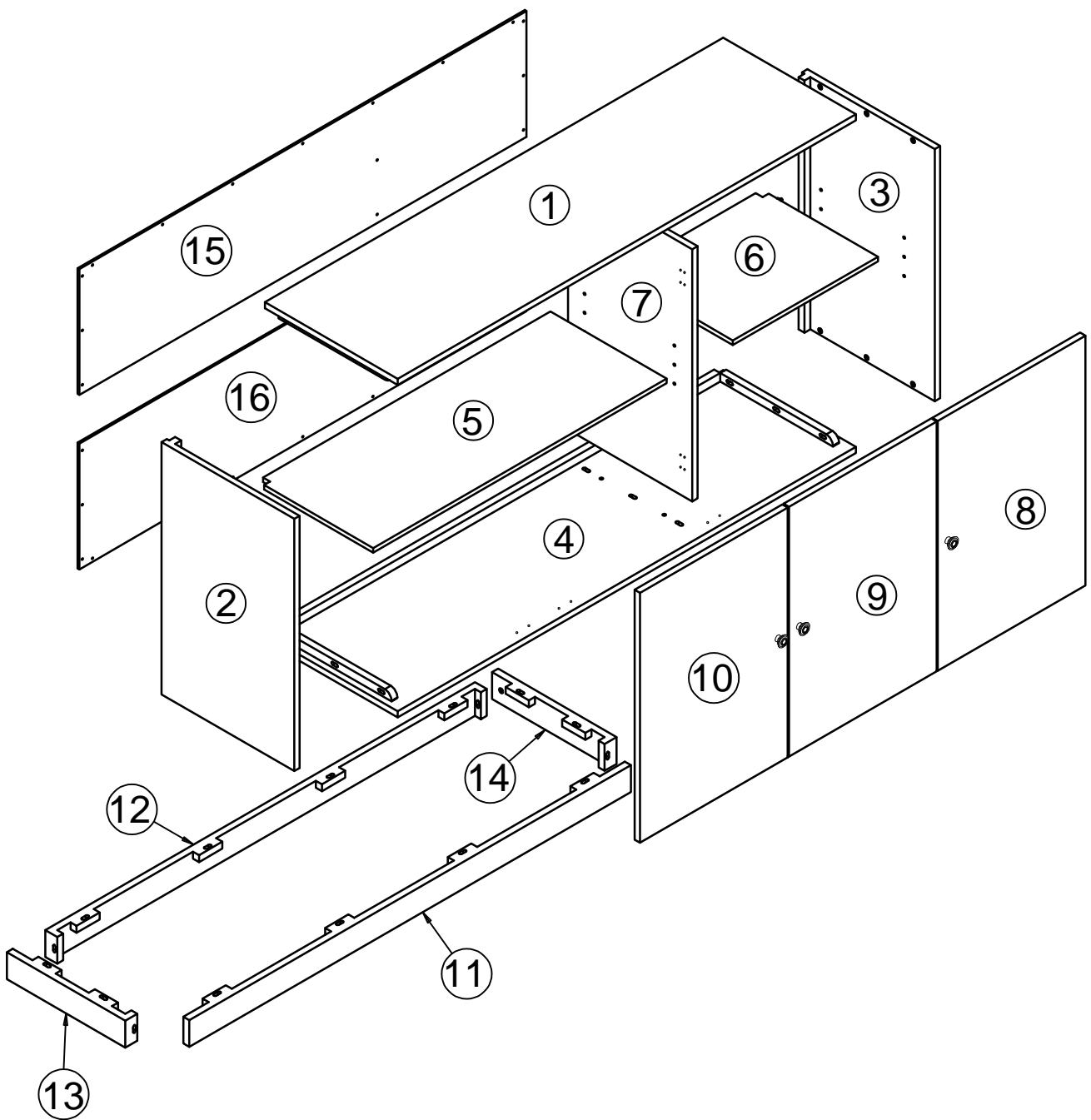

ASSEMBLY INSTRUCTION

ITEM : WF321697
Burl Cabinet w/3 doors

ASSEMBLY INSTRUCTION
ITEM: WF****

Important – Please read these instructions fully before starting assembly

- Check you have all the components and tools listed on the following pages.
- Remove all fittings from the plastic bags and separate them into their groups.
- Keep children and animals away from the work area, small parts could choke if swallowed.
- Make sure you have enough space to layout the parts before starting.

- During assembly do not stand or put weight on the product, this could cause damage.
- Assemble the item as close to its final position (in the same room) as possible.
- Assemble on a soft level surface to avoid damaging the unit or your floor.
- Parts of the assembly will be easier with 2 people.



- To reduce the likelihood of damaging your product please ensure that your power drill is set on a low torque setting.

Care and maintenance

- Only clean using a damp cloth and mild detergent, do not use bleach or abrasive cleaners.
- From time to time check that there are no loose screws on this unit.
- This product should not be discarded with household waste. Take to your local authority waste disposal centre.

Handy Hints

- Assemble all parts and bolts loosely during assembly, only once the product is complete should you fully tighten the bolts
- Regularly check and ensure That all bolts and fittings are tightend properly.

WARNING In order to help prevent overturning – please follow these instructions

To help prevent product toppling over please follow the below steps:-

Use the anti tip stap or wall fixing method provided (if applicable)
Do not allow children to climb or hang on the furniture
Do not open more than one drawer at a time
Do not place heavy items in the top drawers
Do not place heavy items on top of the furniture, unless the furniture has been designed for this purpose

Please note that only the anti tip strap is provided.

You will need to provide wall plugs and screws applicable for your wall type



Tools required



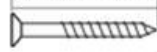

Phillips screwdriver
(medium & large)

Ruler - Use this ruler to help correctly identify the screws





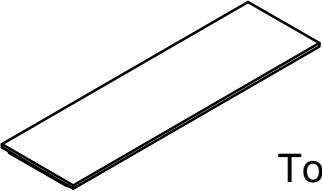

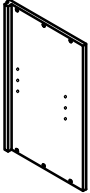
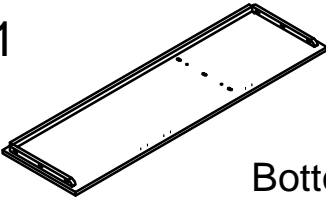
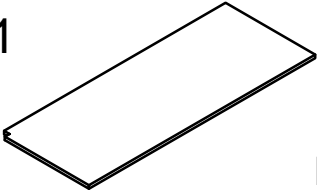
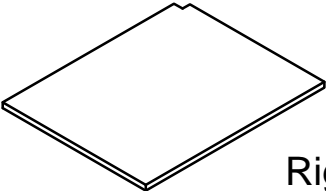
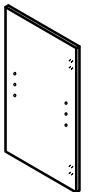
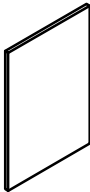
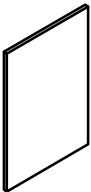
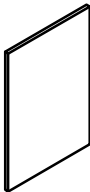
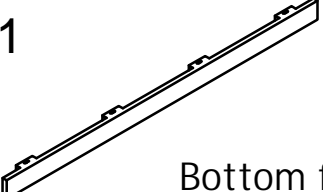
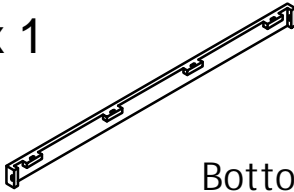
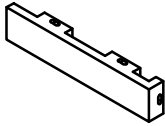
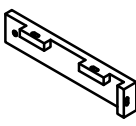
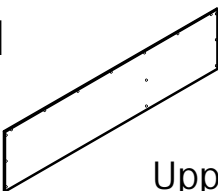
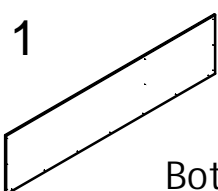





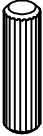

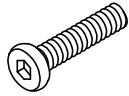
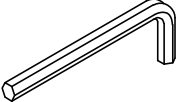
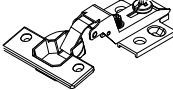
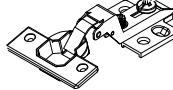
The screws length is measured from the head to the point (30mm screw shown).

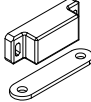
Part List (Box 1 - WF321697)

<p>① x 1</p>  <p>Top panel</p>	<p>② x 1</p>  <p>Left side</p>
<p>③ x 1</p>  <p>Right side</p>	<p>④ x 1</p>  <p>Bottom panel</p>
<p>⑤ x 1</p>  <p>Left shelf</p>	<p>⑥ x 1</p>  <p>Right shelf</p>
<p>⑦ x 1</p>  <p>Partition panel</p>	<p>⑧ x 1</p>  <p>Left door</p>
<p>⑨ x 1</p>  <p>Middle door</p>	<p>⑩ x 1</p>  <p>Right door</p>
<p>⑪ x 1</p>  <p>Bottom front rail</p>	<p>⑫ x 1</p>  <p>Bottom back rail</p>
<p>⑬ x 1</p>  <p>Bottom side rail (Left)</p>	<p>⑭ x 1</p>  <p>Bottom side rail (Right)</p>
<p>⑮ x 1</p>  <p>Upper back panel</p>	<p>⑯ x 1</p>  <p>Bottom back panel</p>

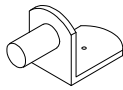
Hardware List

Box 1 - WF321697

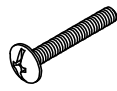
<p>A</p>  <p>Ø8 x 30 mm Wood dowel 2pcs</p>	<p>B</p>  <p>M4x15mm Screw round head 30pcs</p>	<p>C</p>  <p>M6 x 30 mm Allen key bolt 34pcs</p>
<p>D</p>  <p>Allen key 1pcs</p>	<p>E</p>  <p>Adjustable Hinge 4pcs</p>	<p>F</p>  <p>Adjustable Hinge 2pcs</p>
<p>G</p>  <p>M4x15mm Wood Screw 36pcs</p>	<p>H</p>  <p>Magnet And Plate 12pcs</p>	<p>I</p>  <p>M3x10mm Wood Screw 12pcs</p>
<p>J</p>  <p>M3x15mm Wood Screw 12pcs</p>	<p>K</p>  <p>M3.5x10mm Wood Screw 8pcs</p>	<p>L</p>  <p>Shelf Support 8pcs</p>
<p>M</p>  <p>a.  M4 X 15mm - QTY 1 b.  M4 X 40mm - QTY 1</p> <p>FURNITURE TIP OVER RESTRAINT QTY 1 SET</p>	<p>N</p>  <p>Handle 3pcs</p>	<p>O</p>  <p>M4 x 20 mm Bolt 3pcs</p>

ASSEMBLY TOOLS REQUIRED (NOT INCLUDED)



STEP: 1



NOTE: The screwdriver is not included in the hardware pack.

Ax2

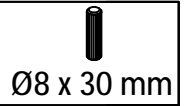

Cx18

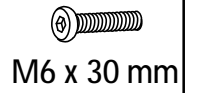

Dx1

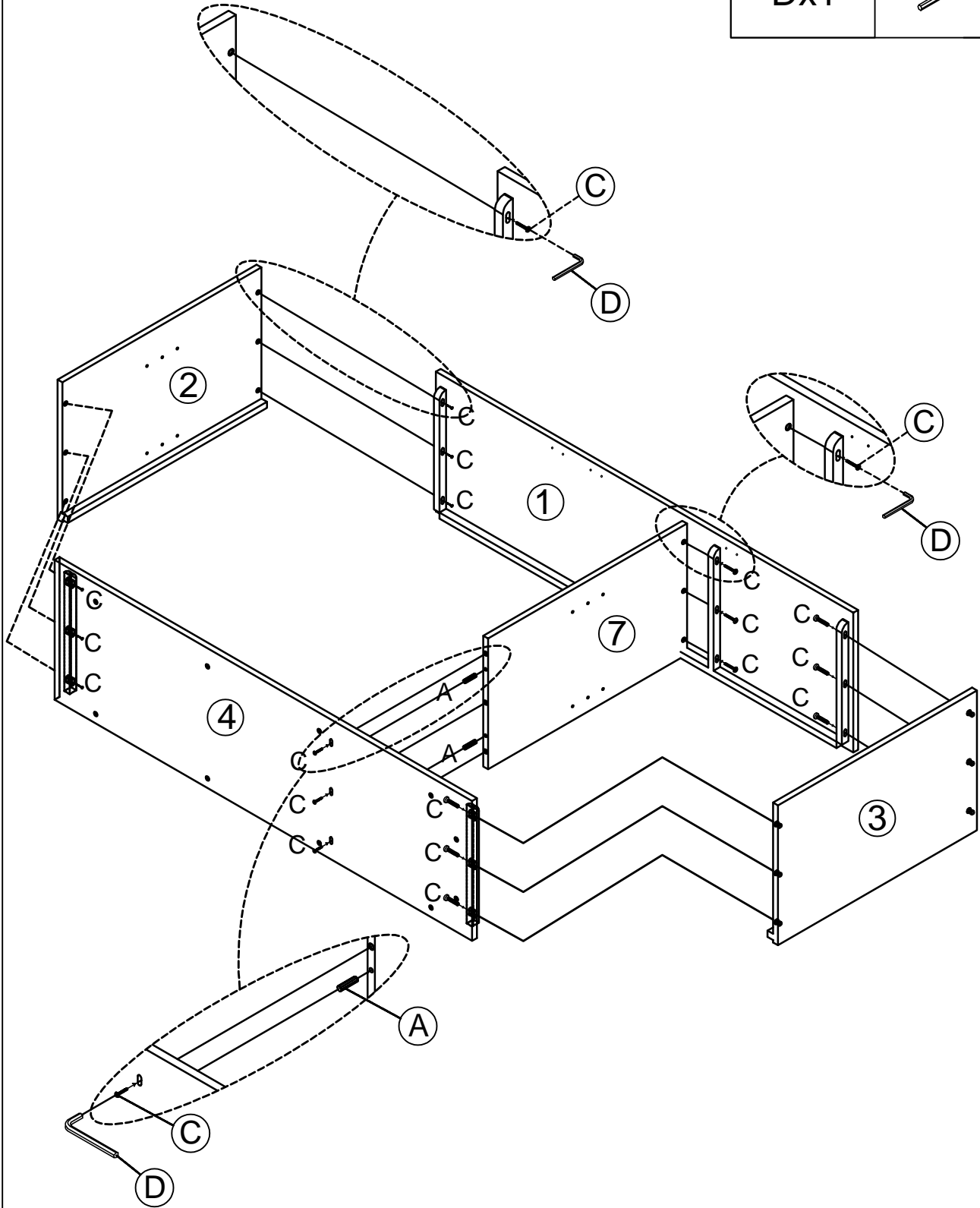

STEP: 2

Cx16

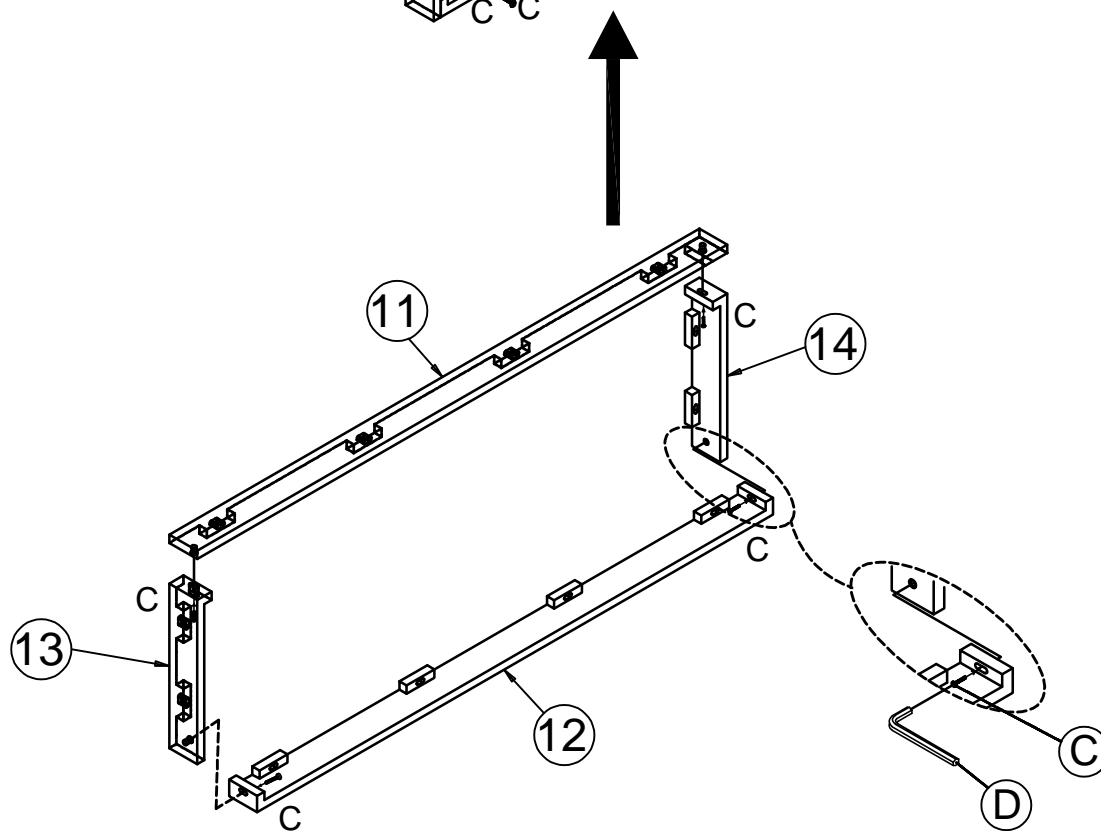
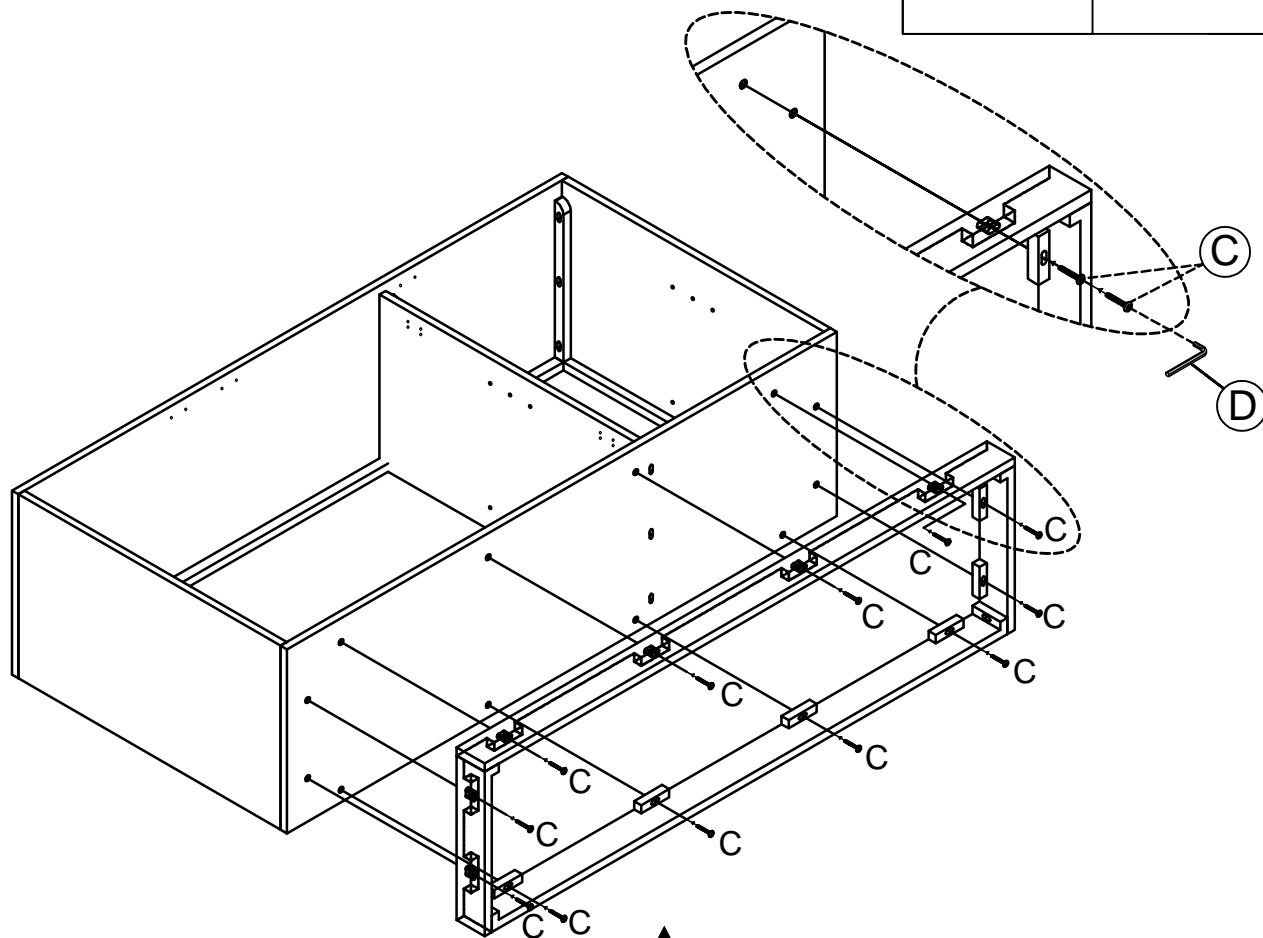

M6 x 30 mm

Dx1



STEP: 3



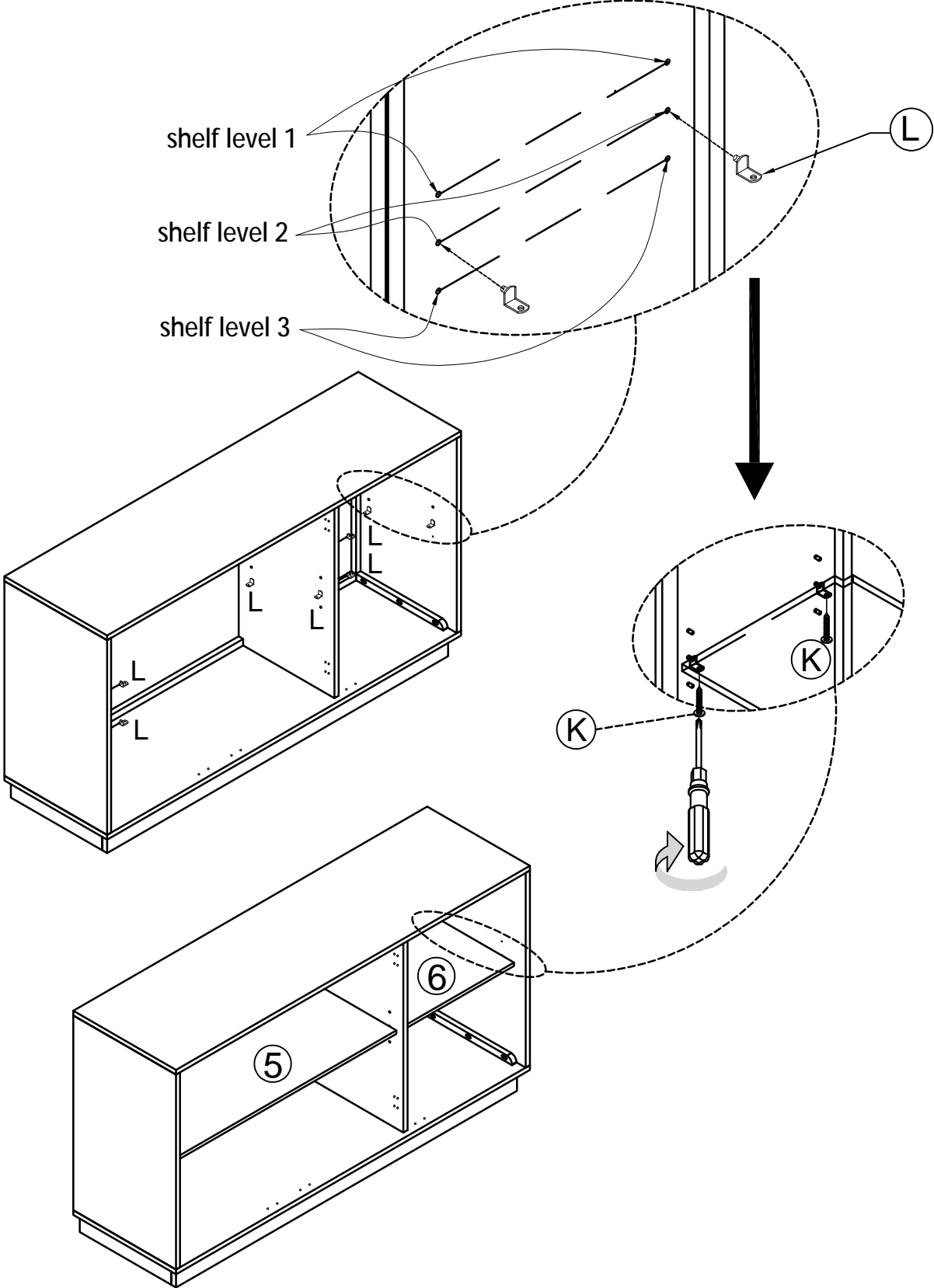

NOTE: The screwdriver is not included in the hardware pack.

Kx8	 M3.5x10mm
Lx8	 2x15x15mm



STEP: 4





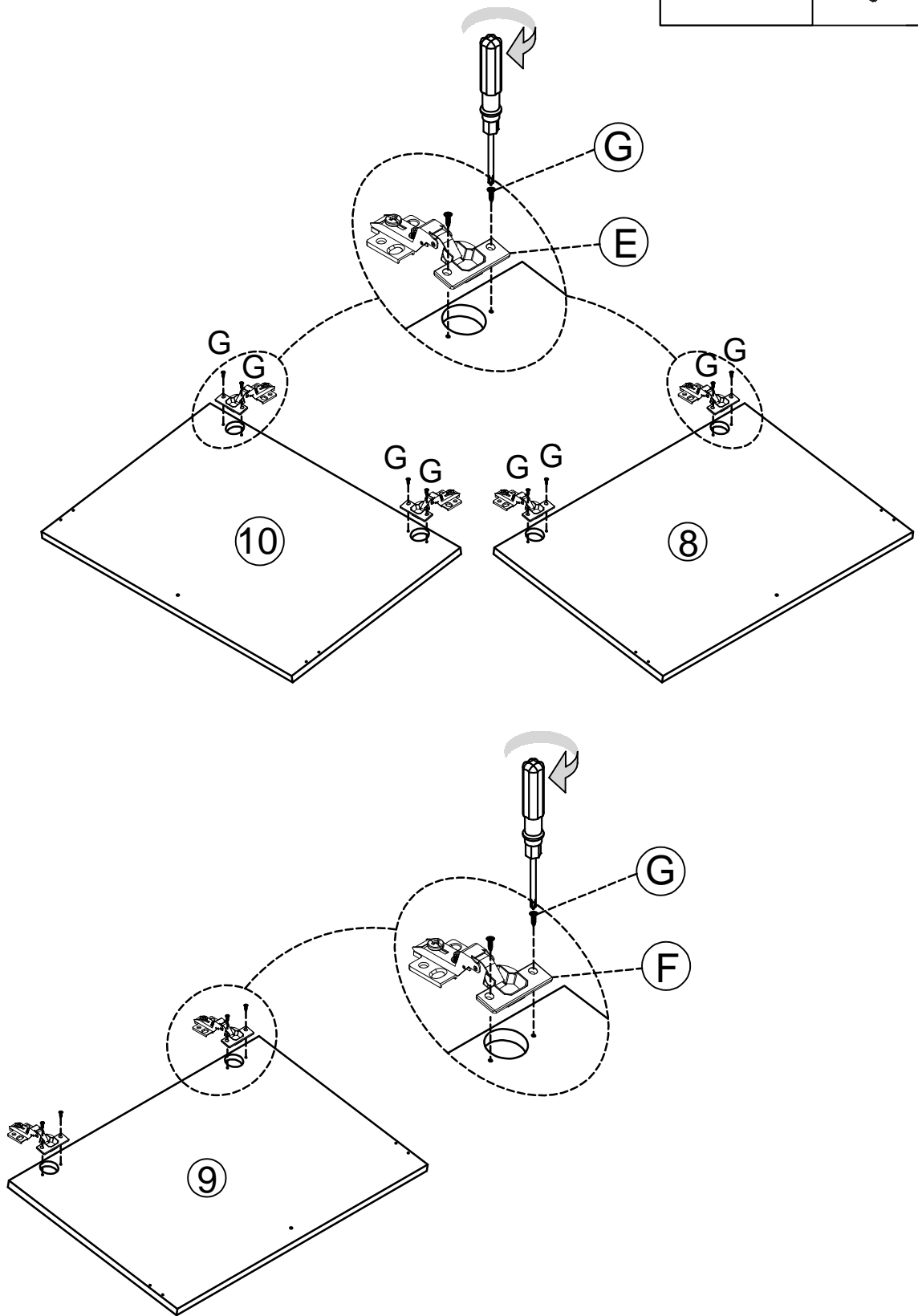

NOTE: The screwdriver is not included in the hardware pack.

Gx12	 M4x15mm
Ex4	
Fx2	



STEP: 5

NOTE: The screwdriver is not included in the hardware pack.

Gx24	 M4x15mm
Hx12	
Ix12	 M3x10mm
Jx12	 M3x15mm
Nx3	
Ox3	 M4 x 20 mm

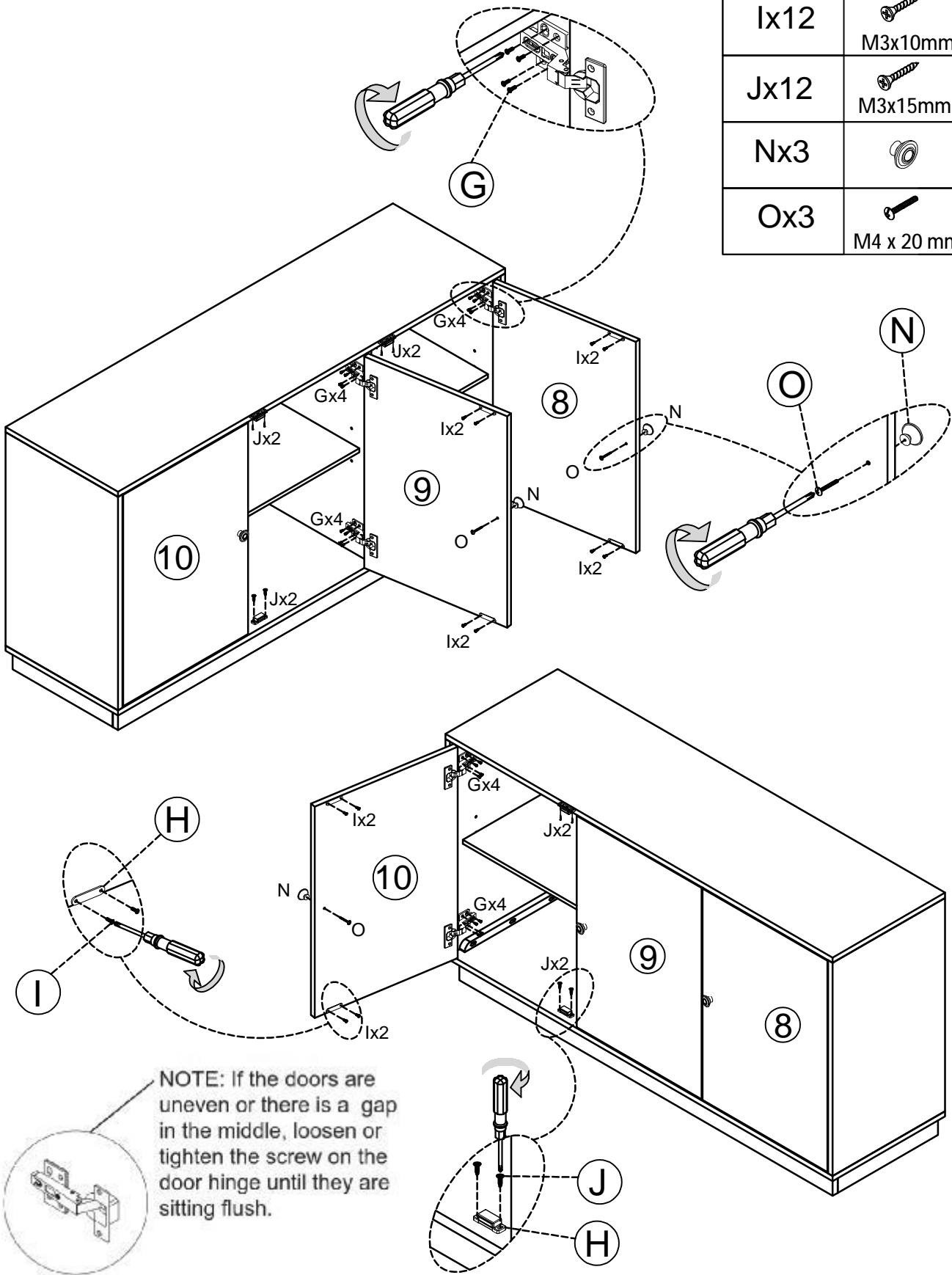

NOTE: If the doors are uneven or there is a gap in the middle, loosen or tighten the screw on the door hinge until they are sitting flush.

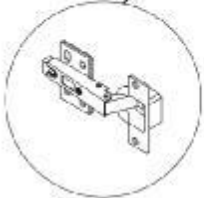

STEP: 6

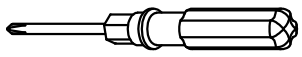
NOTE: The screwdriver is not included in the hardware pack.

Bx30

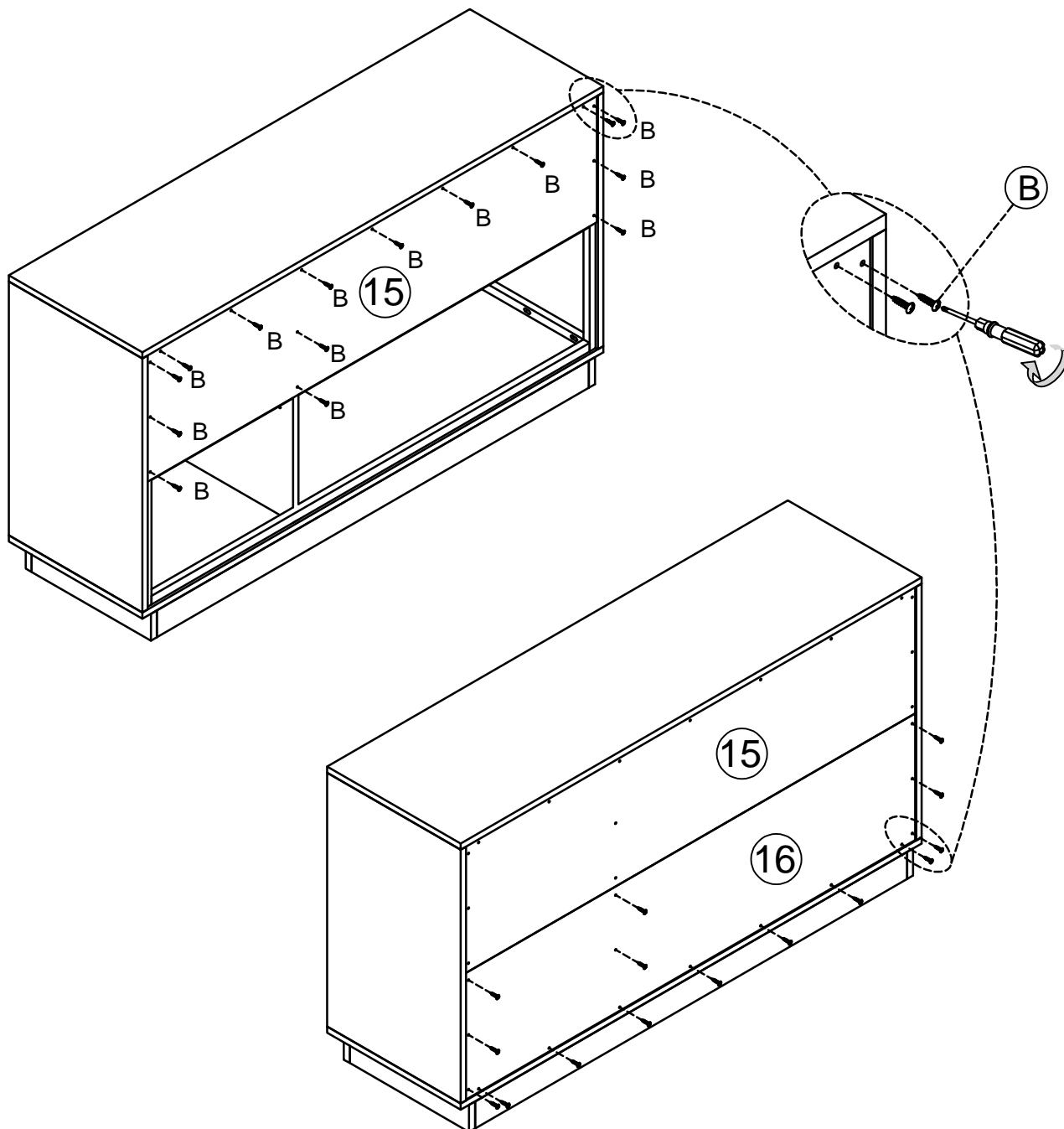

M4x15mm



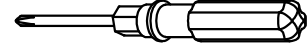

WARNING

Serious or fatal crushing injuries can occur from furniture tip-over.
If the furniture tip over restraint kit is not in the box, please contact our customer service department in order to obtain another kit before using the furniture.



NOTE: The screwdriver is not included in the hardware pack.

STEP: 7

