

SKU:WF321486

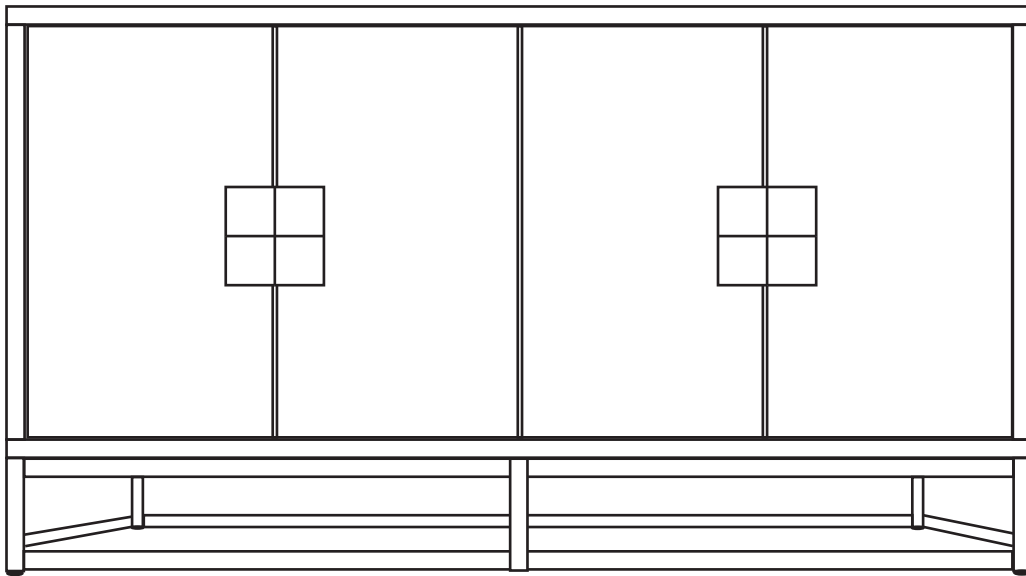

1. Thank you for choosing *our products*.

2. Return Policy







DO NOT RETURN TO THE STORE! Skip the process of returning your product and contact us directly for a replacement

If you find that parts of your order are missing or damaged, we will gladly ship any needed replacement parts free of charge.

If your product's quality does not meet your expectations or you have found any sort of defect, please contact our customer service department and let us know the details of your order and any issues encountered, we will try our best to provide you with a solution. Feel free to also directly contact our manufacturer concerning needed replacement parts and they will be happy to help provide you with a solution or answer any questions you may have.

Recommendations Before Beginning Assembly

-  • Read instructions, cover to cover
-  • Have 2-4 adults on hand for assembly depending on product size
-  • Do not assemble directly on flooring or carpet
-  • Assemble on a clean non-marring surface (example: packing foam)
-  • Save all packaging until finished











3. Assembly Notice:

- If you encounter any problems during assembly and find that you cannot continue, rest assured we will help you solve the situation as soon as possible. Simply keep all of the parts of the product stored in a safe place and contact us immediately so we may assist you further.
- Once you have opened your package, remove all inner hardware packages and take the parts out. One by one, Place the parts out neatly in front of you, then refer to the instructions to ensure no parts are missing. If any pieces are found missing, please carefully look in the box first, as the hardware packaging might have torn making the

hardware spill in the box.

- Some key parts of your product may be stored and hidden inside of other parts. Please open any zippered or hook & loop storage compartments to remove all parts. (example: cushions and legs being stored in the underside of a sofa)
- **IMPORTANT:** When setting up your product, **DO NOT INSTALL THE SCREWS ALL THE WAY IN THE BEGINNING.** Place each screw into their proper hole and use your hand to twist the screw halfway. Twist all the screws in halfway to ensure the holes will match up properly and the product is level on the ground. When everything seems fitted, then tighten the screws.
- When you have completed assembly, we suggest you have more than one person to assist you with lifting and placing the product.

Care & Maintenance

-  Do not put hot items directly on furniture surface
-  Do not clean furniture with harsh cleansers or polish
-  Do not place furniture under direct sunlight
-  Do not place furniture near heating or cooling vents
-  Do not write on furniture without a padded barrier to protect the surface
-  Do not place furniture outside. For indoor use only
-  Not for commercial use. For residential use only
-  Stains may be removed with mild soap solution and damp cloth
-  Children should not climb or jump on the furniture
-  Dust and pick-up spills using a clean, non-colored, lint-free cloth





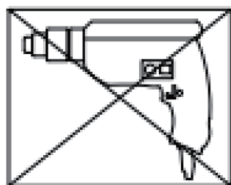



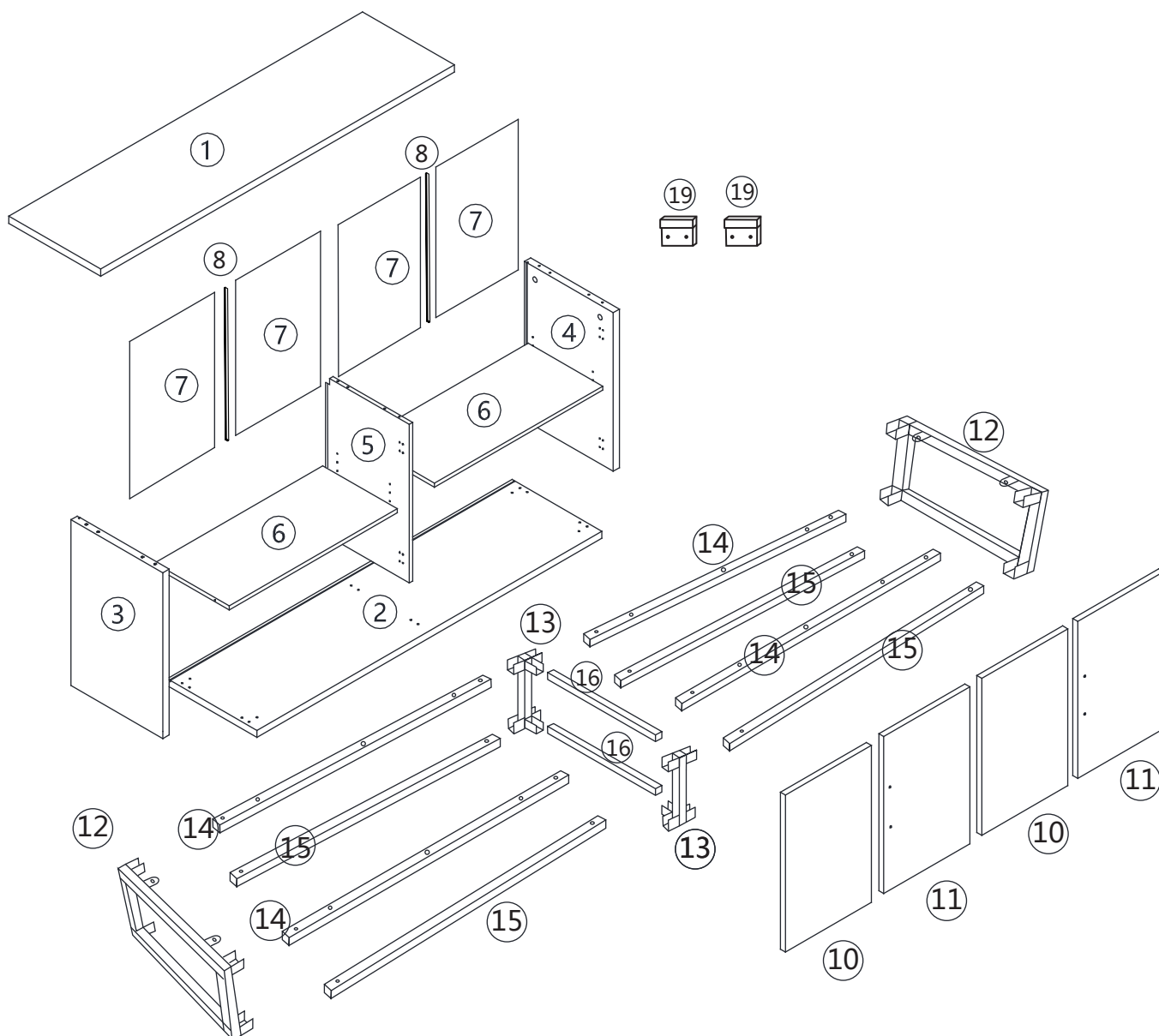
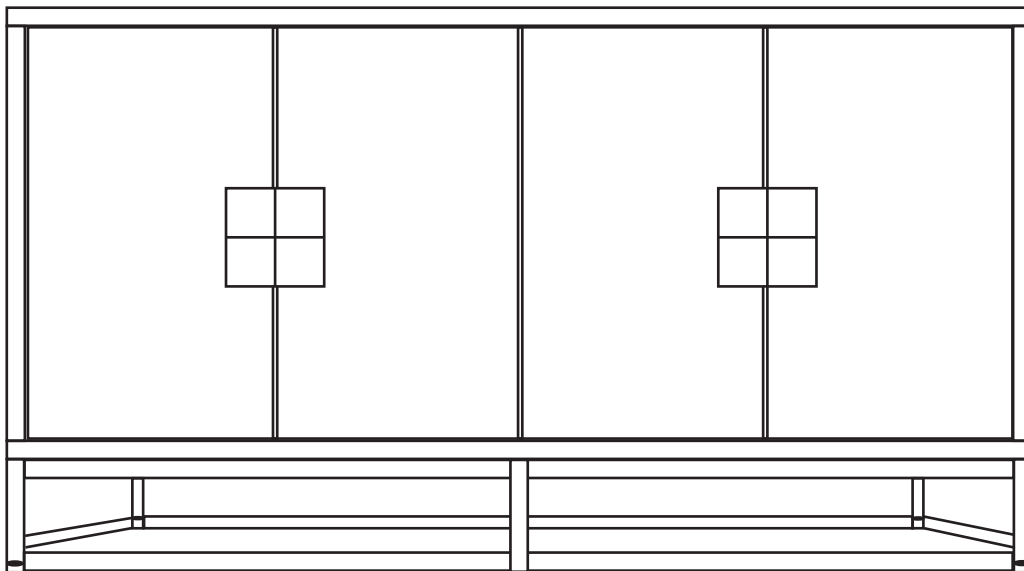





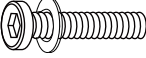

Caution

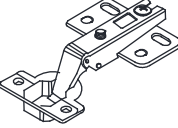
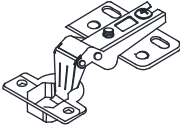
- This product contains small components. Please ensure that they are kept away from small children.
- Do not use power tools to assemble your furniture. Power tools may strip or damage the parts.

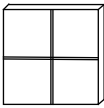

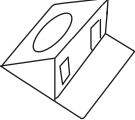
SKU:WF321486

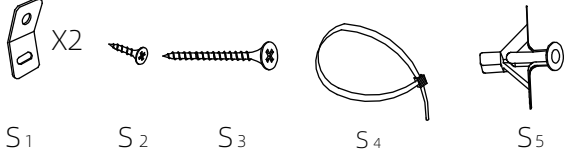

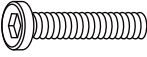

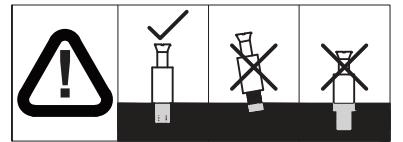

 Ø 6x35mm AX2	 Ø 15x12mm BX2	 Ø6x30mm CX4	 Ø5x50mm DX2	 EX1
 Ø8x40mm FX8	 Ø3x14mm GX8	 Ø3.5X35mm HX12	 IX8	 Ø6x12mm JX20
 KX4	 LX4	 Ø 4x16mm MX48	 NX2	 Ø6x30mm OX4
 PX8	 QX1	 RX4	 S ₁ S ₂ S ₃ S ₄ S ₅ SX1	
 Ø3x25mm TX4	 Ø8x20mm UX4			

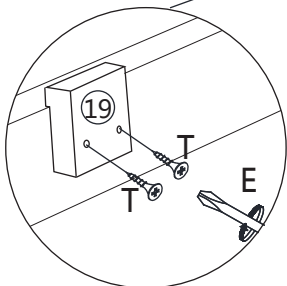
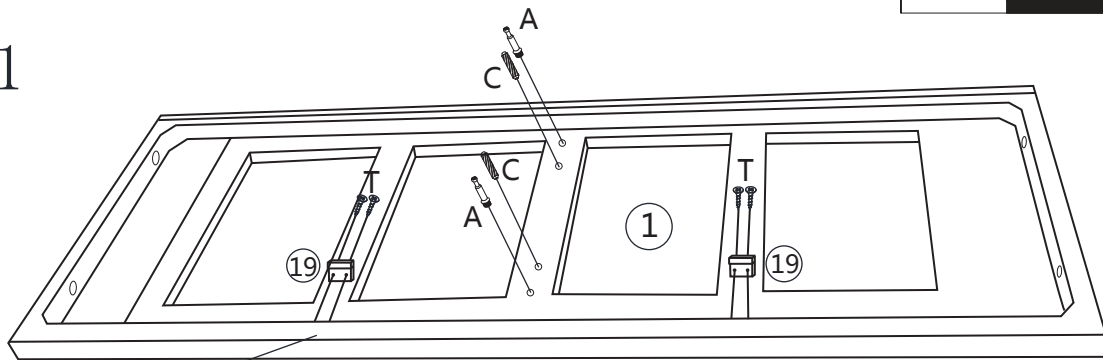





STEP 1

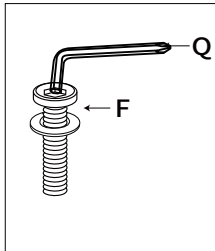
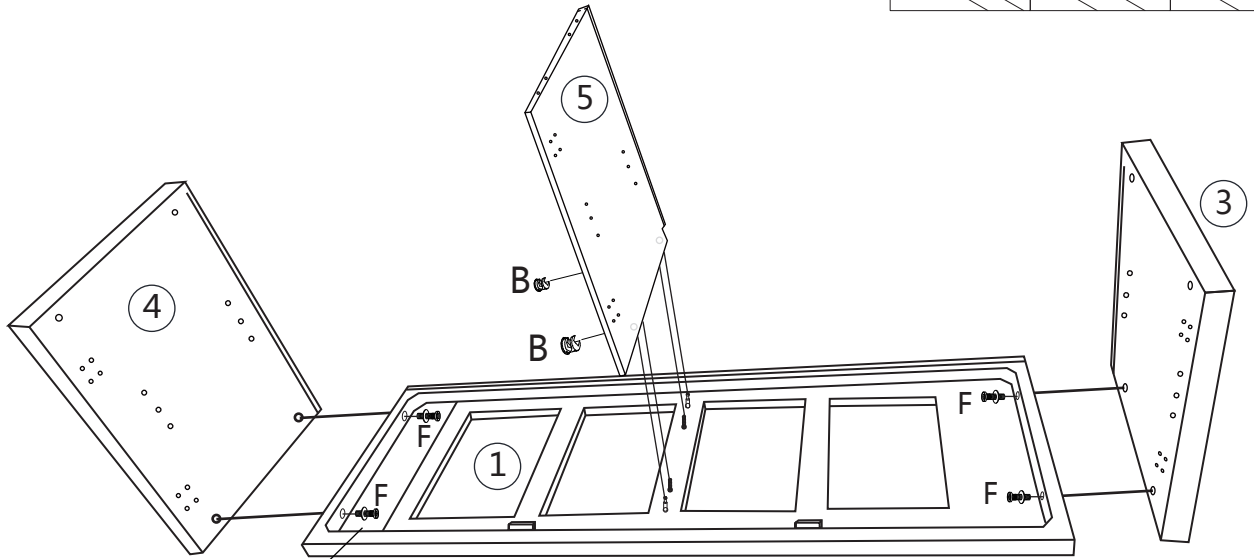
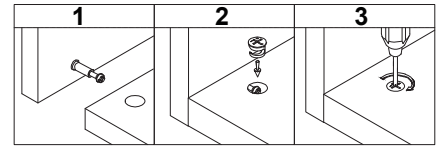

 Ø 6x35mm AX2	 Ø6x30mm CX2	 EX1	 Ø3x25mm T X4
---	---	---	---

STEP 2

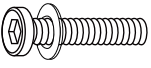



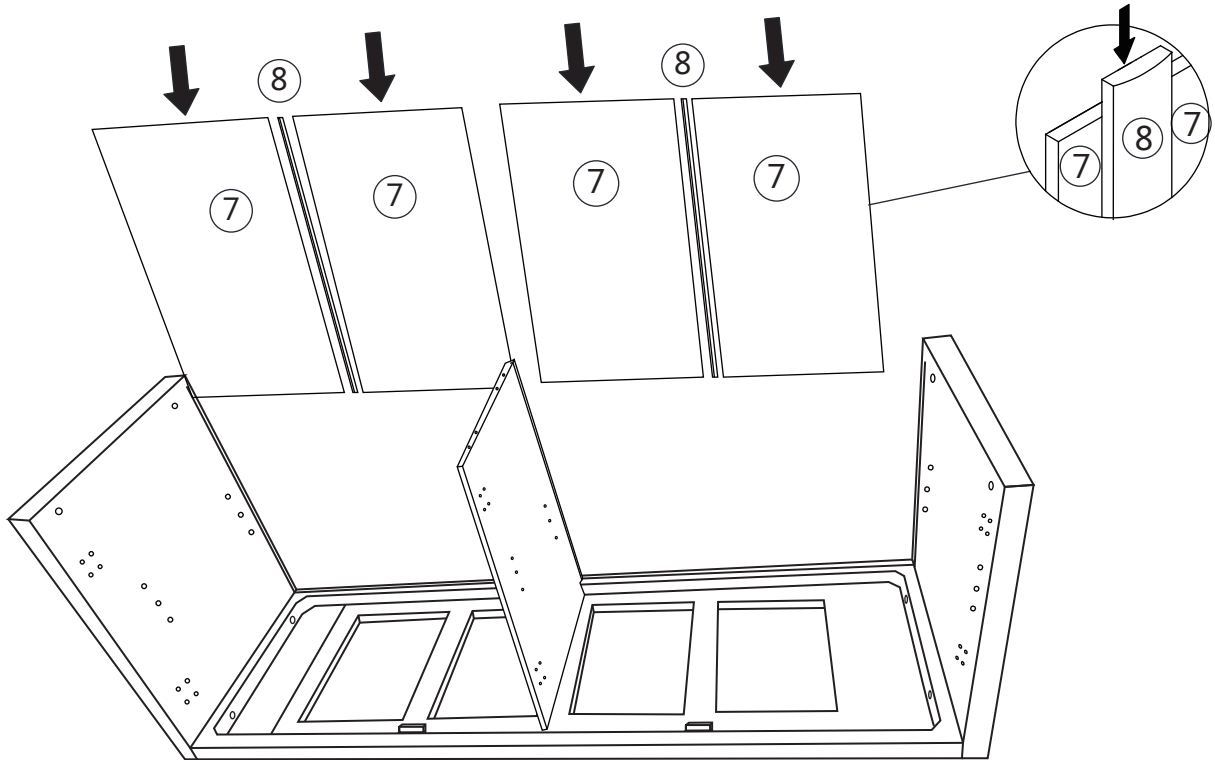

		
Ø15x12mm	Ø8x40mm	
BX2	FX4	QX1

STEP 3

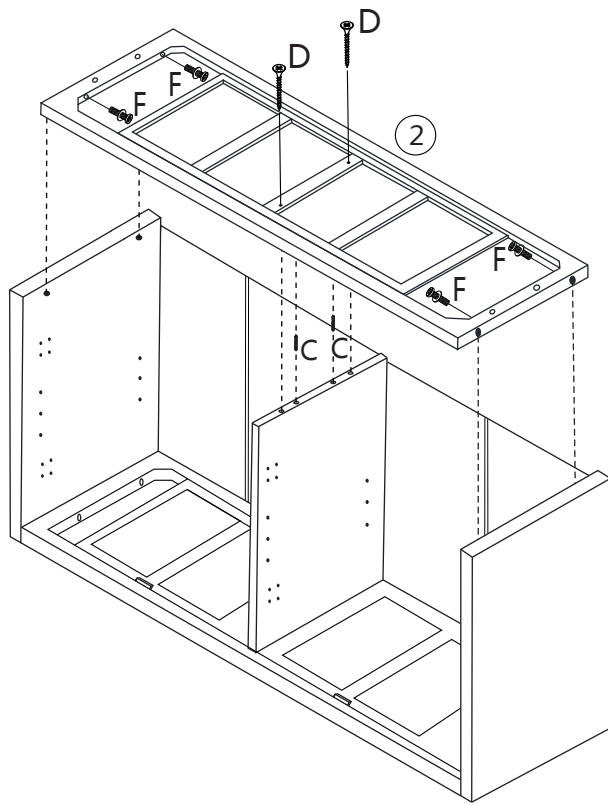



STEP 4

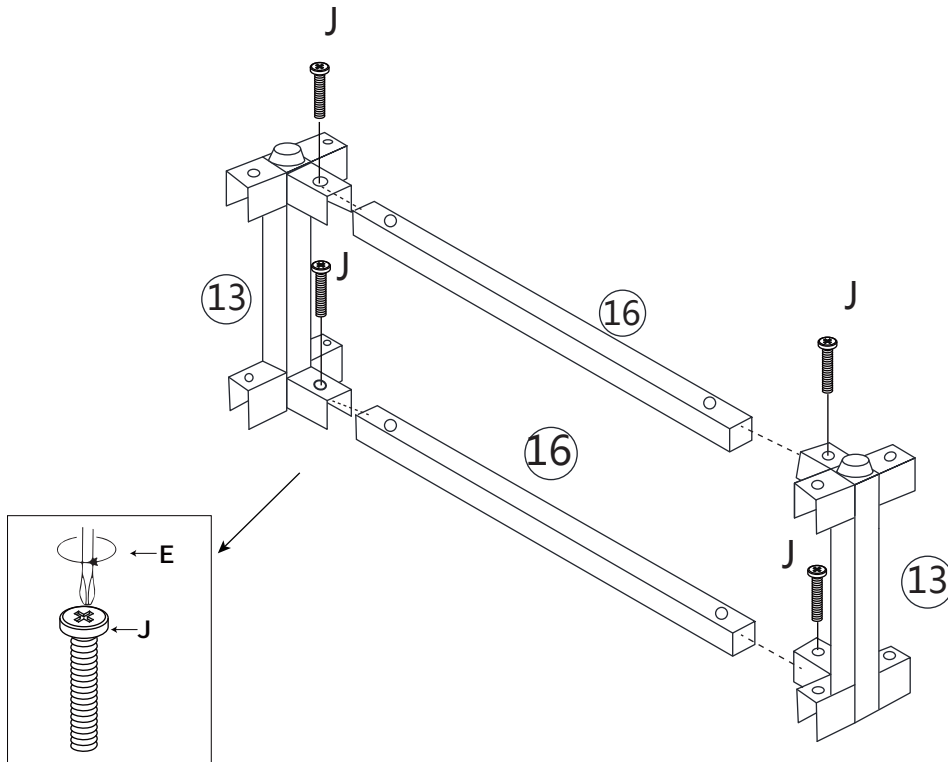

		
Ø6x30mm	Ø5x50mm	Ø8x40mm
CX2	DX2	FX4

STEP 5



Ø6x12mm
JX4

STEP 6

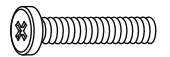
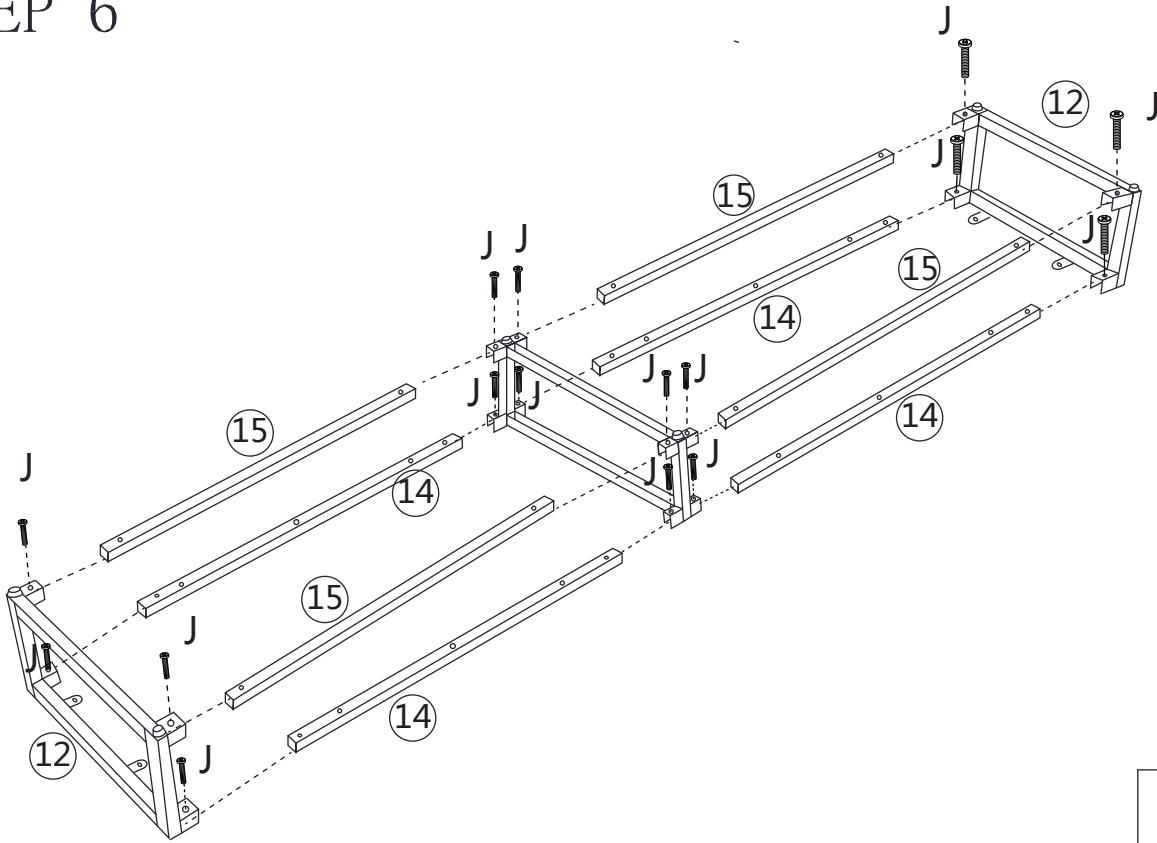

Ø6x12mm

JX16

STEP 7

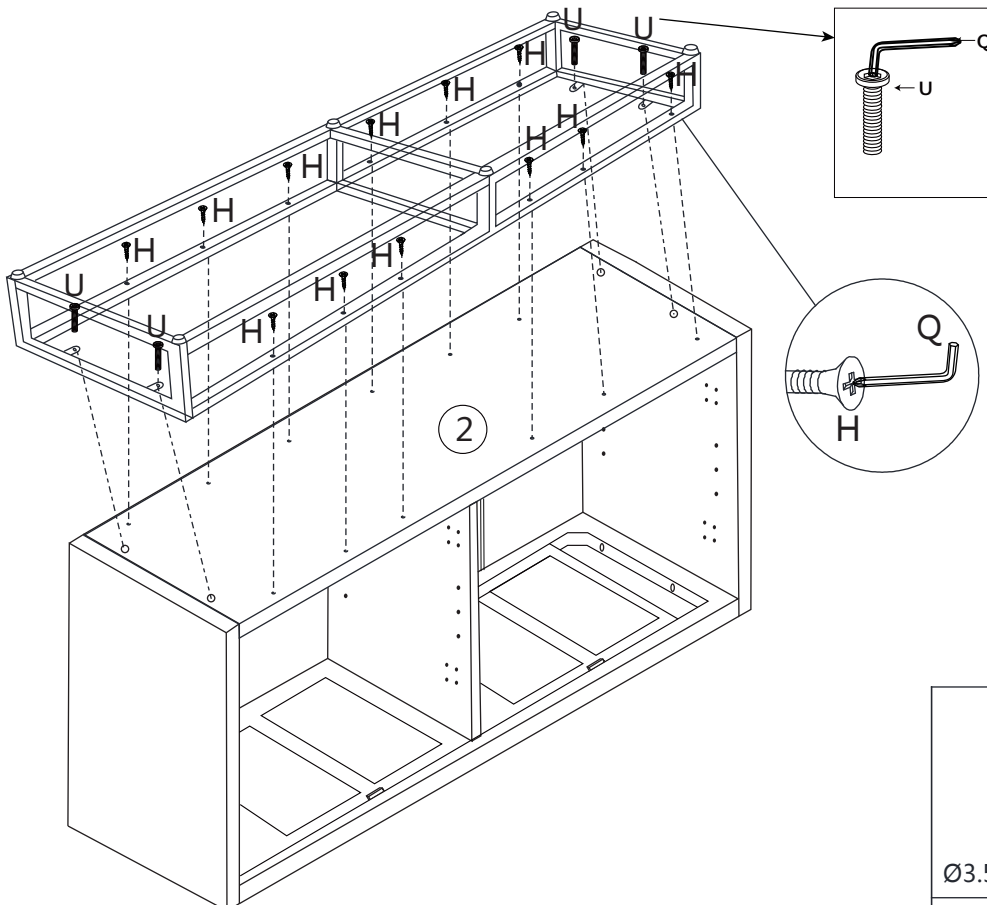

Ø3.5X35mm

HX12

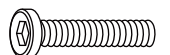



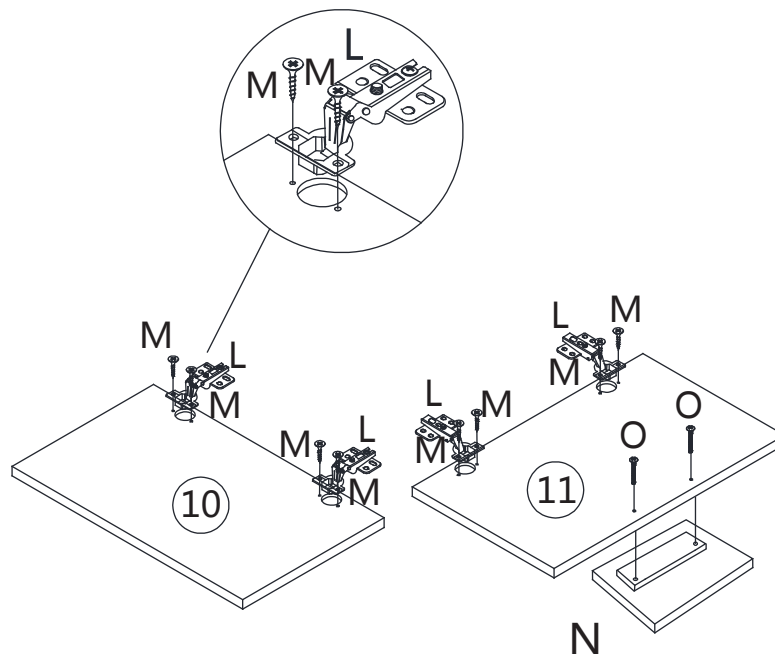

Ø8x20mm

UX4

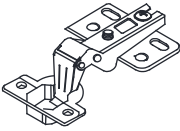
STEP 8

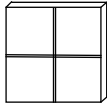

	 Ø 4x16mm		 Ø6x30mm
LX4	MX8	NX1	OX2

STEP 9

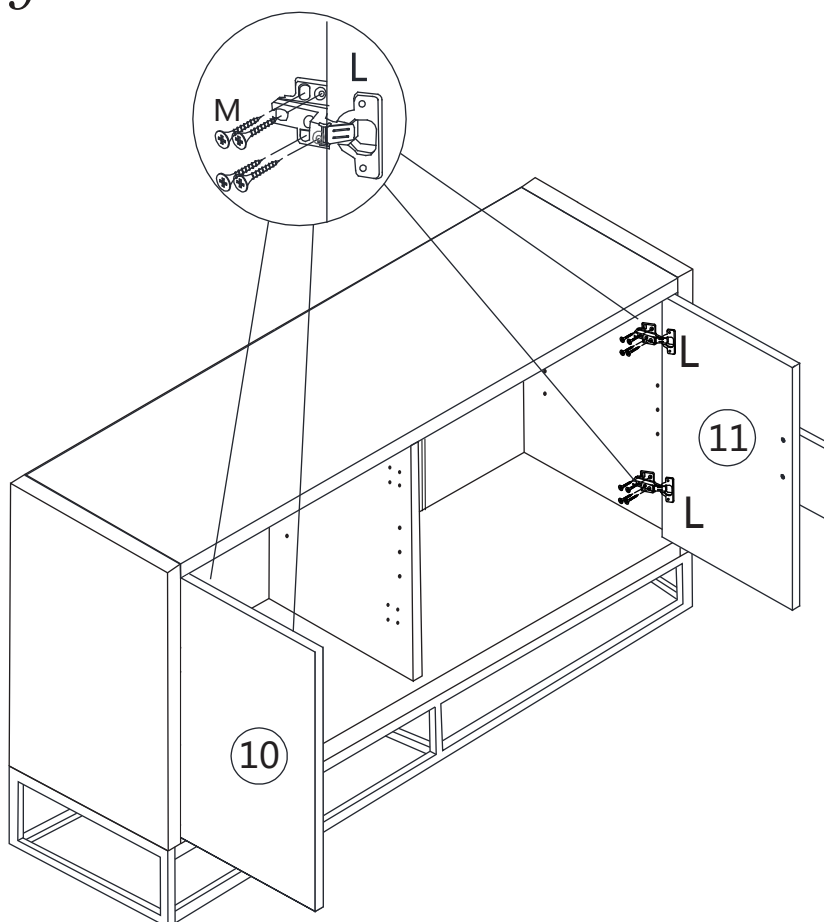

 Ø4X16mm
MX16

STEP 10

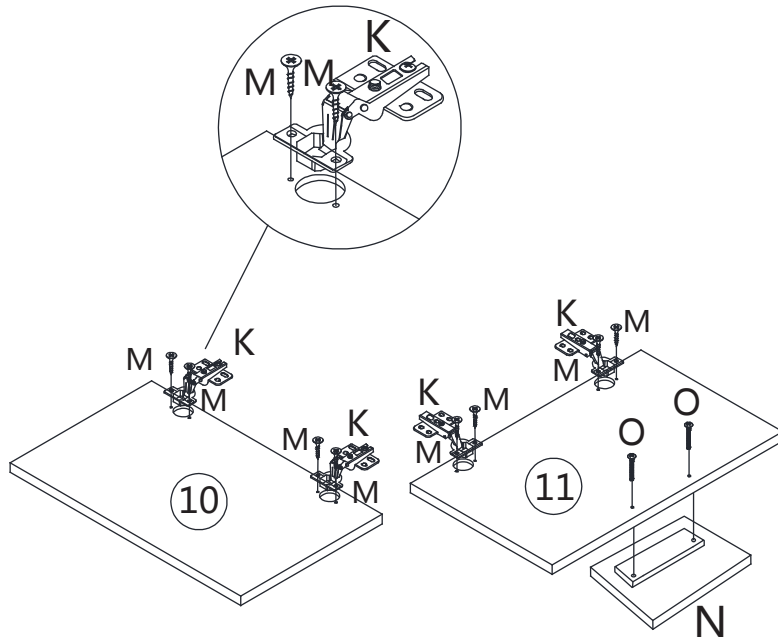

KX4	MX8	NX1	OX2

STEP 11

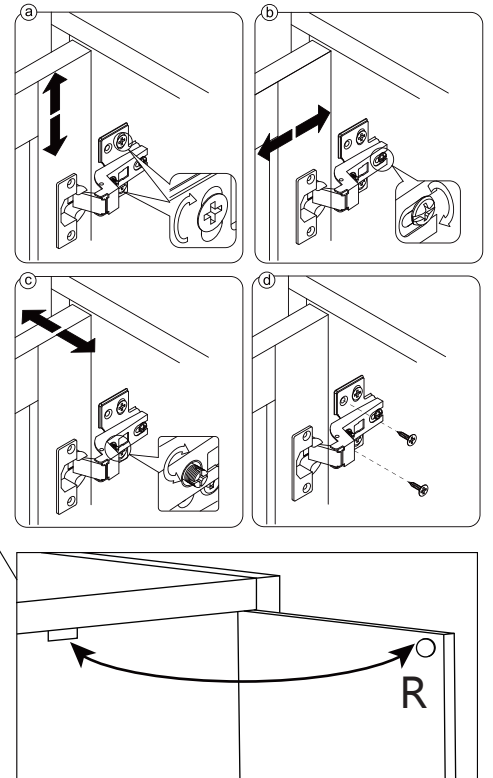
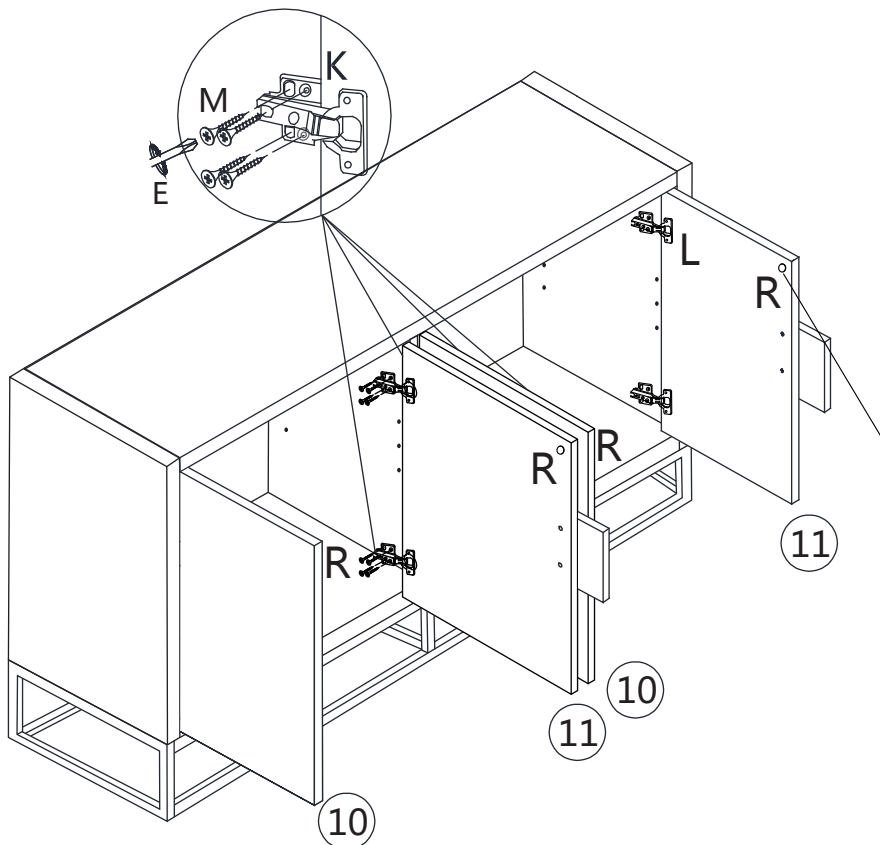

R X4	MX16

STEP 12

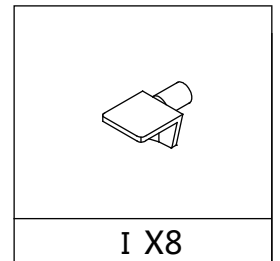
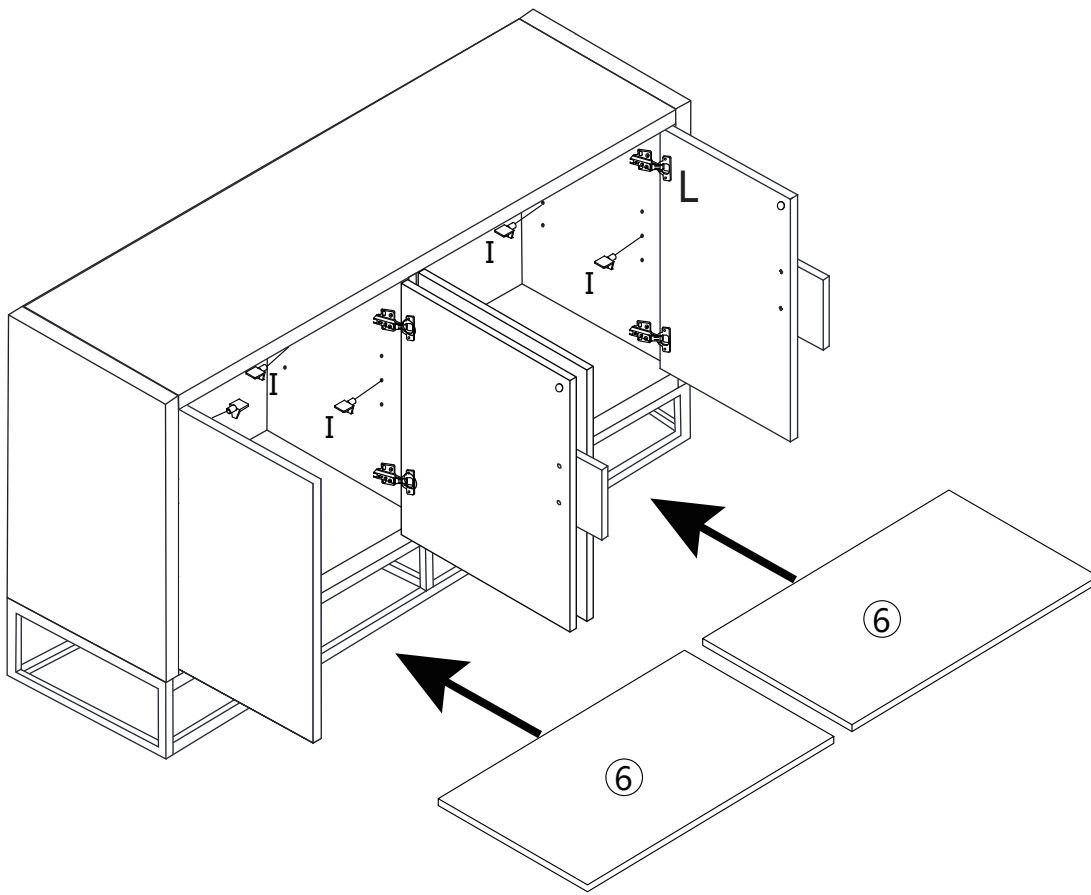

STEP 13

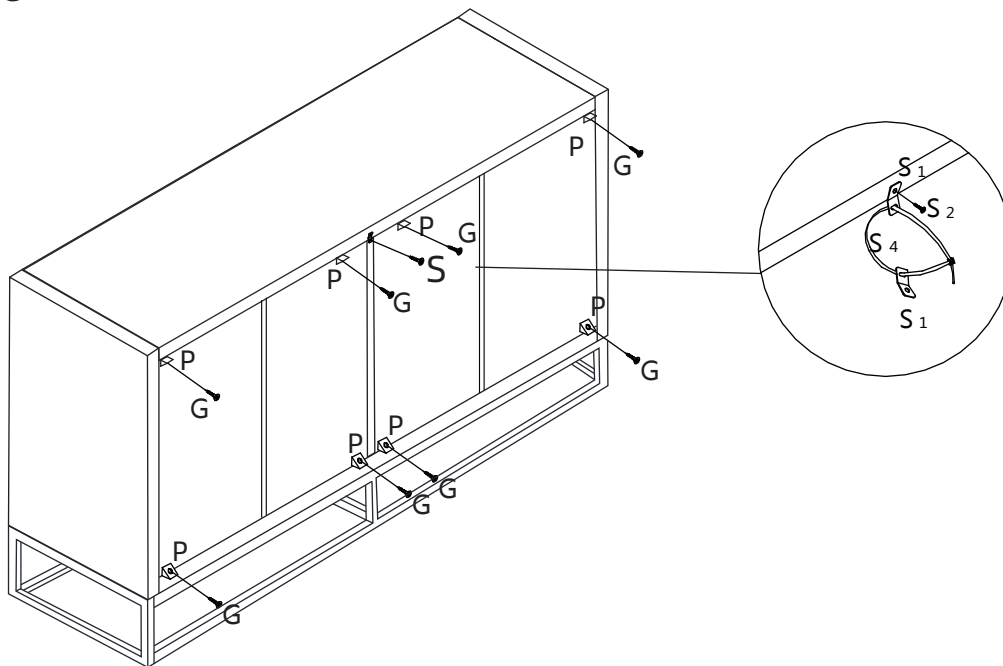

<p>PX8</p>	<p>Ø3x14mm GX8</p>	<p>S₁ S₂ S₄</p>
<p>S X1</p>		

STEP 14

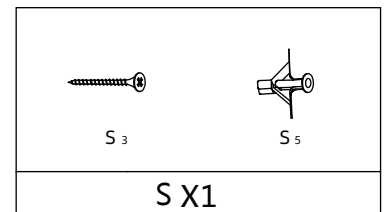
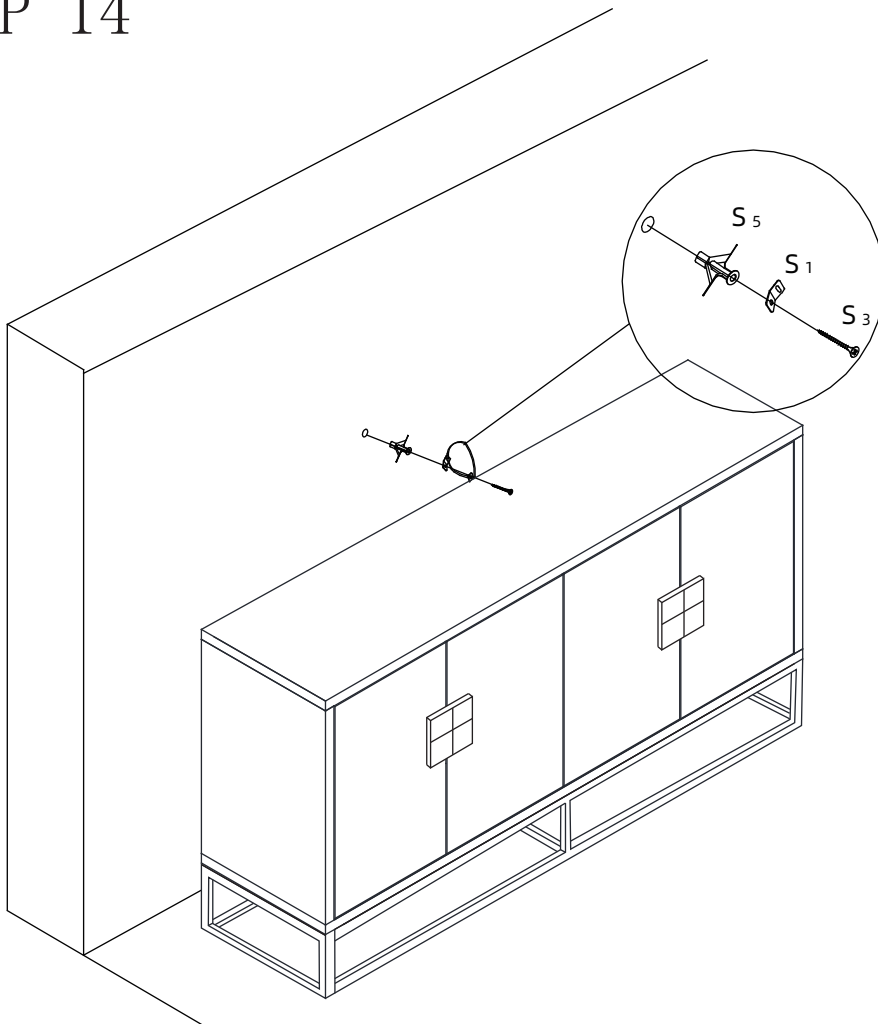

STEP 15

Assembly Steps(EN) / Montageschritte(DE)

HOW TO ADJUST THE HINGES TO ALIGN THE DOORS IF NEEDED.

STEP 1

Open the door.

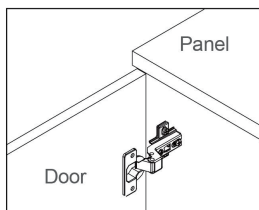

STEP 3

Adjust the flush between door panel and side panel

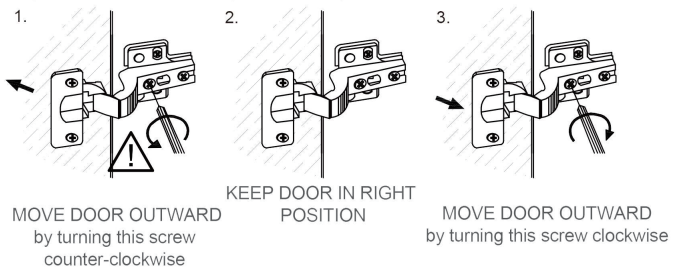

STEP 2

Adjust the door panel upward or downward

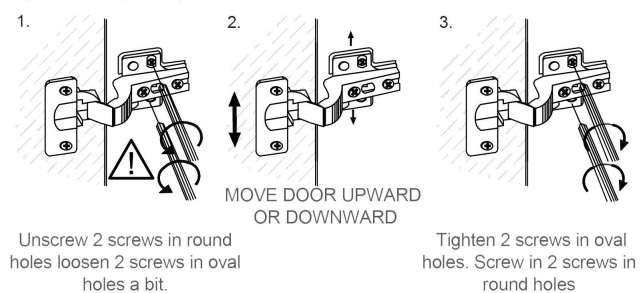

STEP 4

Adjust the Gap between door panel and side panel

