

Parts List

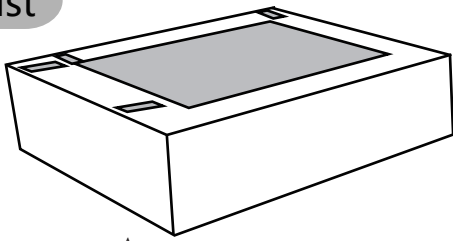

A

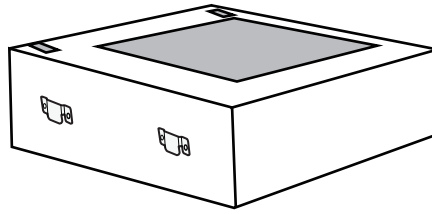

B*2

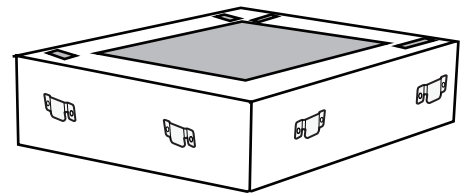

C

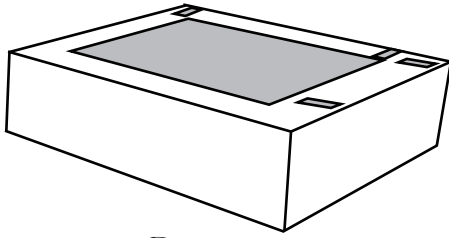

D

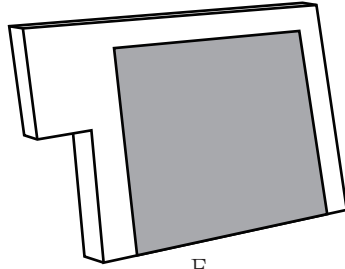

E

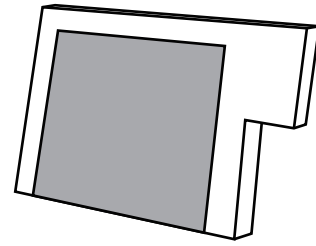

F

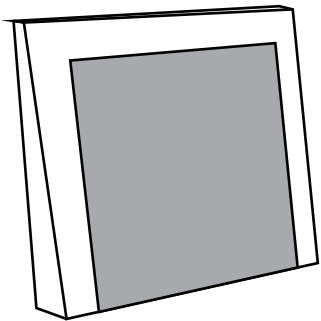

G*2

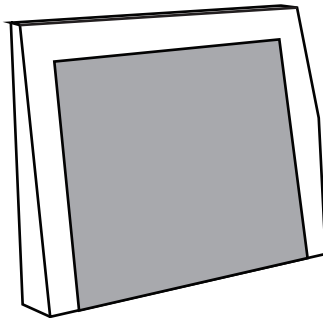

H

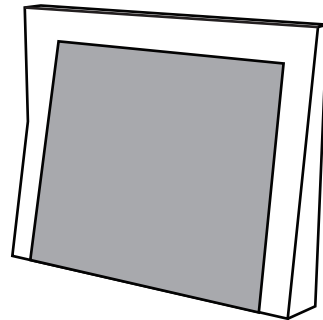

I

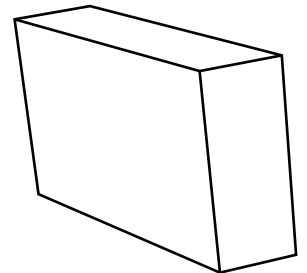

J*2



K * 16

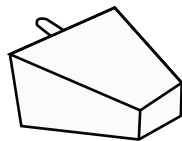

L * 20

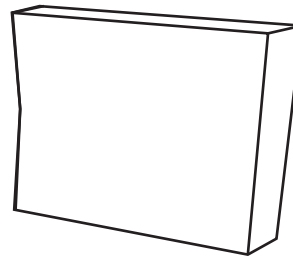

M

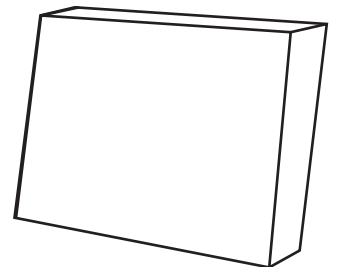

N*5

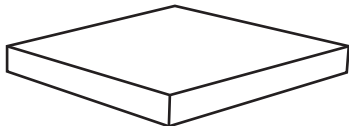

O

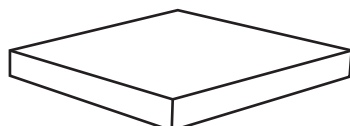

P*2

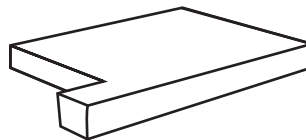

Q

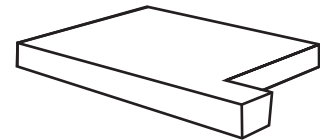

R



S*2

WF304681-BOX 5-1: E+G*2+I+F+H+S*2
 WF304682-BOX 5-2: C+J*2+O+K*16+L*20
 WF304683-BOX 5-3: A+D+Q+R
 WF304684-BOX 5-4: B*2+P*2
 WF304685-BOX 5-5: N*5+M

Installation method

Step 1:

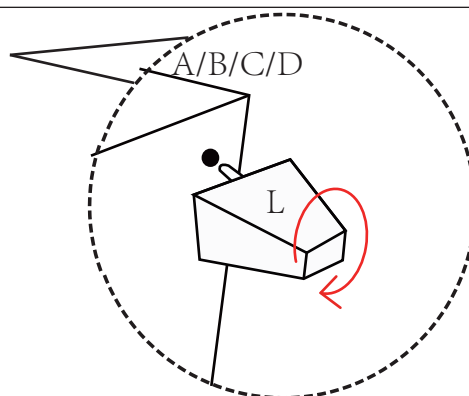
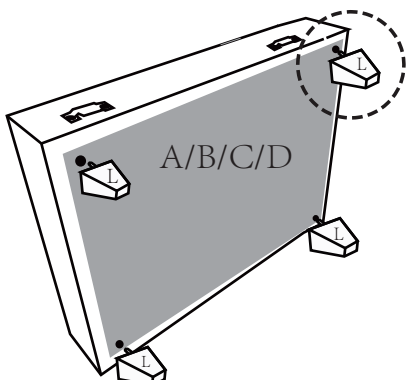

Step 2:

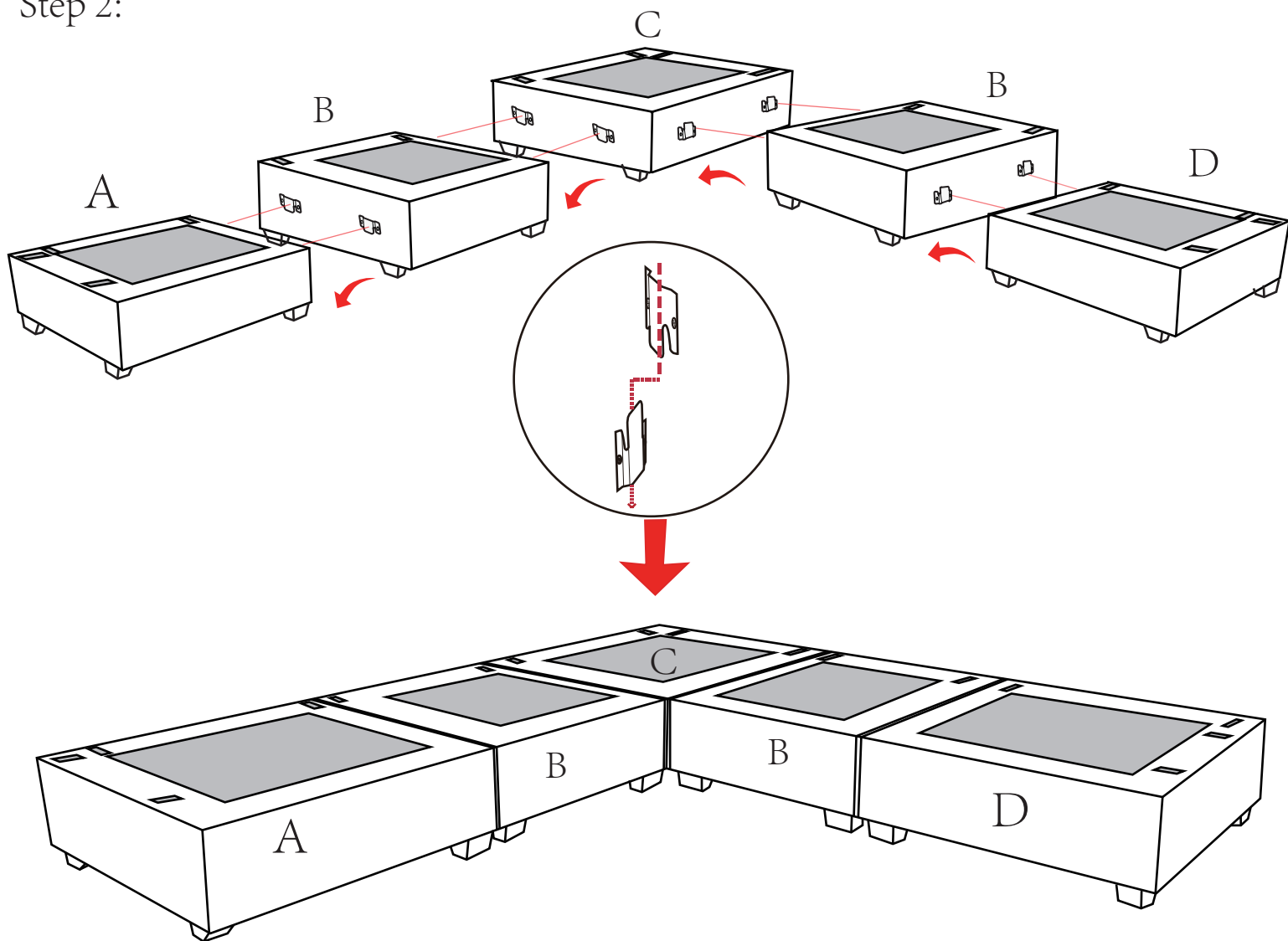

Step 3:

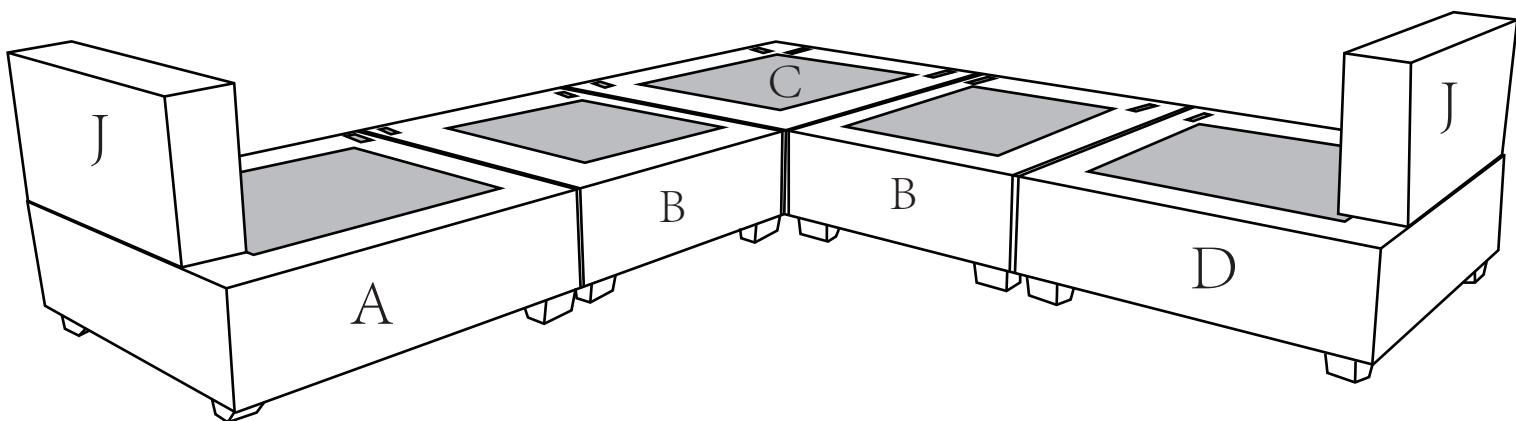
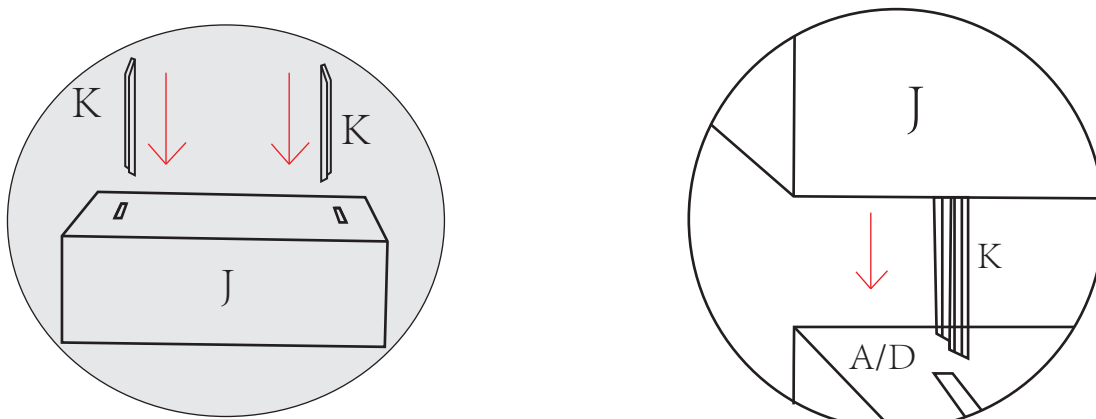

Step 4:

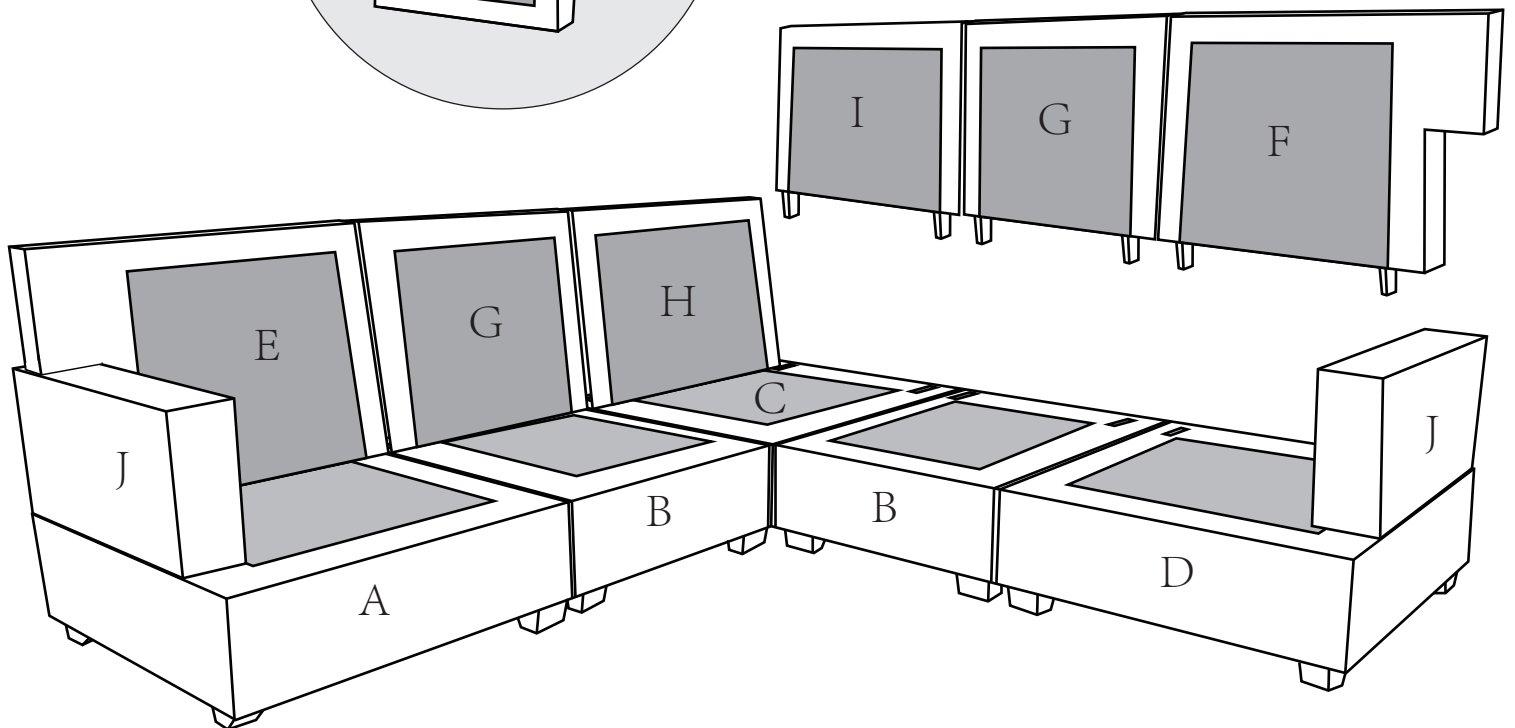
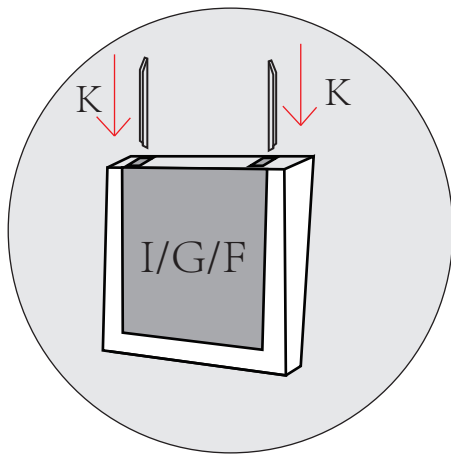
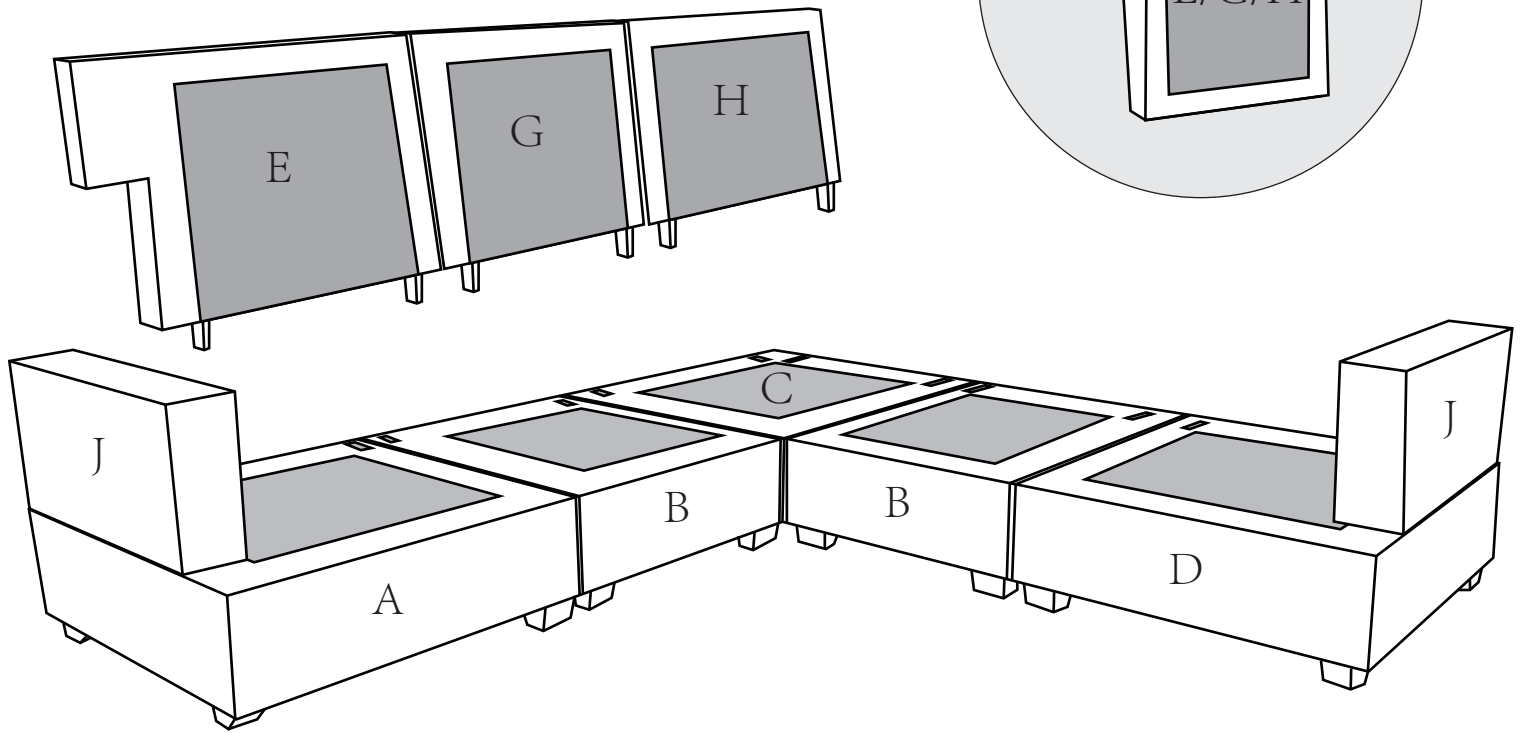
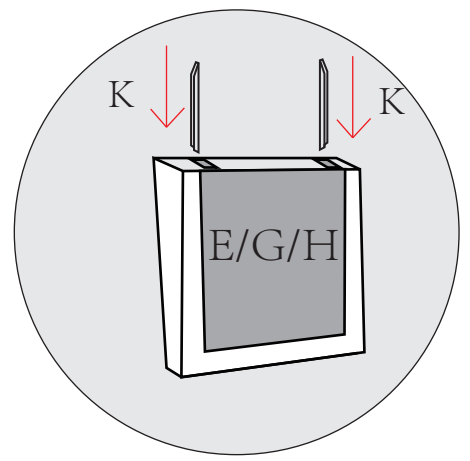

Step 5:

