

Assembly Instructions

A x 1

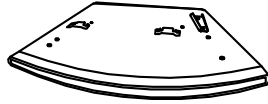

B x 1



C x 8



M6x20mm

D x 1

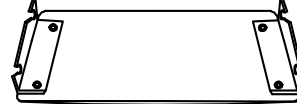

E x 1

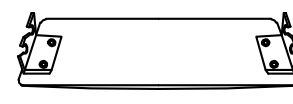

F x 1

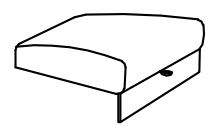

G x 1

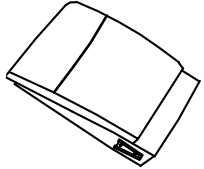

H x 1

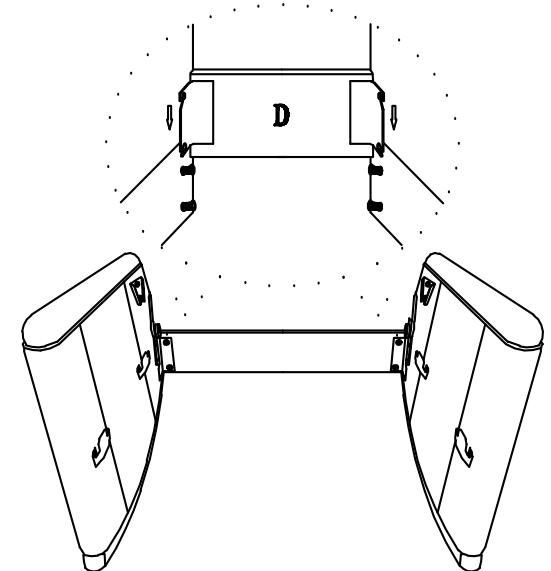
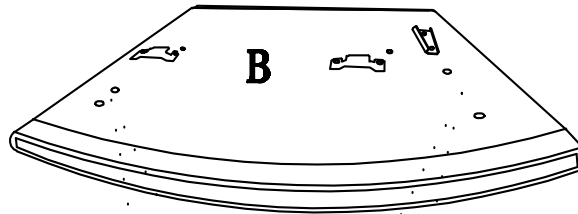
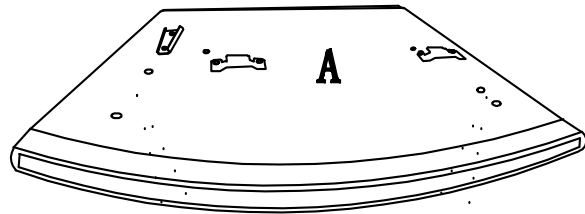

1

2

3

