

Assembly Instructions

A x 1

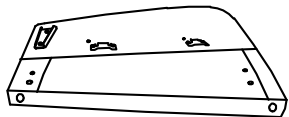

B x 1

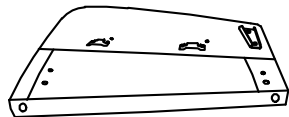

C x 8



D x 1



E x 1

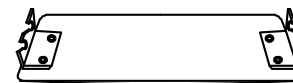

F x 1

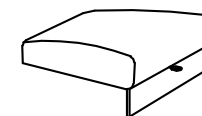

G x 1

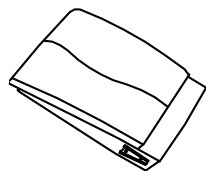

H x 1

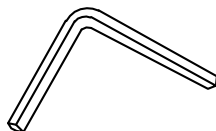

R x 2



J x 4

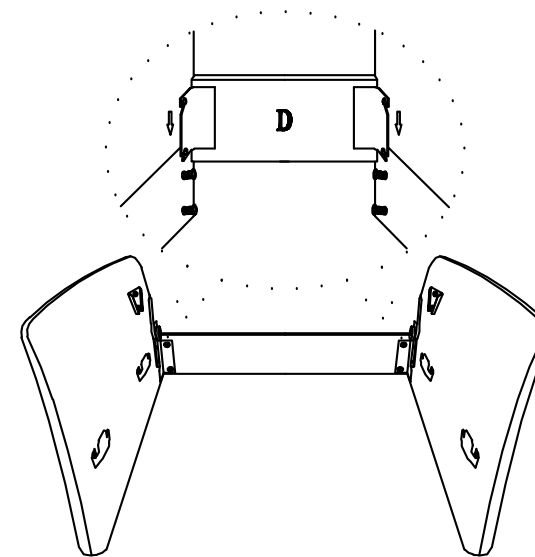
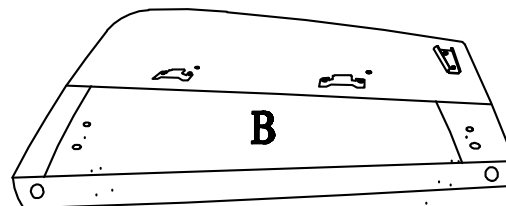
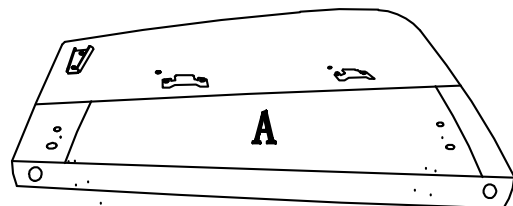

1

2

3

