

TRIPLE BUNK BED  
ASSEMBLY INSTRUCTIONS  
SKU MF287723/287724

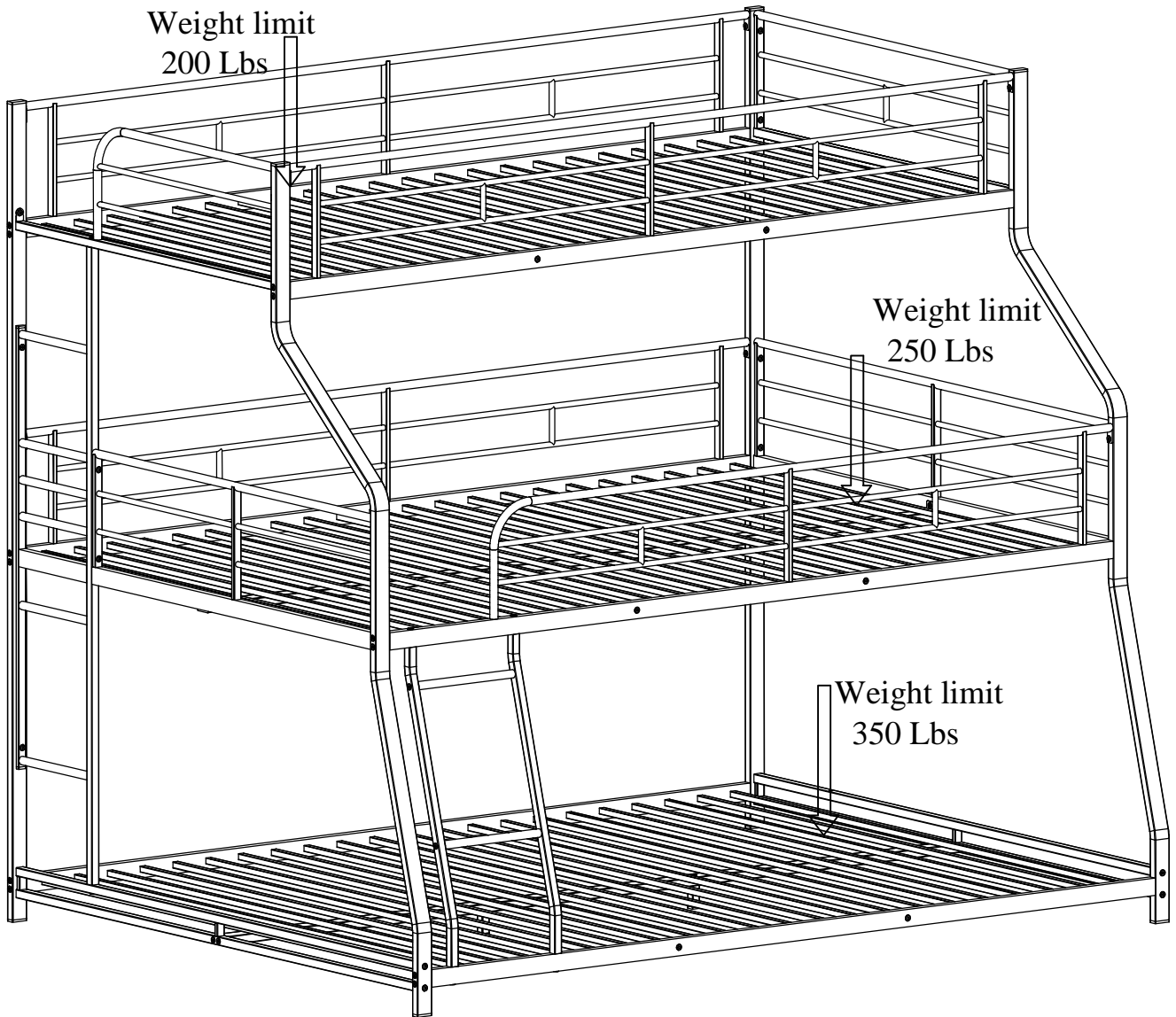

TRIPLE BUNK BED  
ASSEMBLY INSTRUCTIONS  
SKU MF287723/287724

**SAFETY WARNINGS AND GENERAL NOTES:**

1. Follow the information on the warnings on the bunk bed end structure and on the carton. Do not remove the warning label from the bed.
2. Always use the recommended size mattress on mattress support, or both, to help prevent the likelihood of entrapment or falls.
3. Do not allow children under 6 years of age to use the upper bunk.
4. Periodically check and ensure the guardrail, ladder and other components are in their proper position, free from damage, and all connectors are tight.
5. Do not allow horseplay on or under beds.
6. Always prohibit jumping on the bed.
7. Prohibit more than one person on upper bunk.
8. Always use the ladder for entering and leaving the upper bunk.
9. Do not use substitute parts. Contact the manufacturer or dealer for replacement parts.
10. Use of a night-light may provide added safety precaution for a child using the upper bunk.
11. Always use guardrails on both long sides of the upper bunk.
12. If the bunk bed will be placed next to a wall, the guardrail that runs the full length of the bed should be placed against the wall to prevent entrapment between the bed and the wall.

The use of water or sleep flotation mattresses is prohibited.

13. **STRANGULATION HAZARD-** Never attach or hang items to any part of the bunk bed that are not designed for use with the bed; for example, but not limited to, hook, belts and jump ropes.

14. Keep these instructions for future reference.

15. We recommend assembling your bunk bed on the shipping carton to protect your floor or carpet.

16. Be certain all staples are out of the box before beginning assembly on the shipping carton.

17. **USE ONLY MATTRESSES WHICH ARE AS THE TABLE BELOW ON UPPER AND ON LOWER BUNKS.**

Upper bunk (bunk bed and tribed included)

Bed type	Length	Width	Thickness
Twin	79" – 80"	38 ½"	6" max
Full	79" – 80"	53"-54"	6" max

Lower bunk

Bed type	Length	Width	Thickness
Queen	79" – 80"	60"	8"

18. **SURFACE OF MATTRESS MUST BE AT LEAST 5" (127MM) BELOW THE UPPER EDGE OF GUARDRAILS.**

19. Replacement Parts:

Replacement Parts, including additional guardrails, may be obtained from any of our (GIGACLOUD TECHNOLOGY(USA) INC.) dealers

TRIPLE BUNK BED  
ASSEMBLY INSTRUCTIONS  
SKU MF287723/287724

DETAIL VIEW

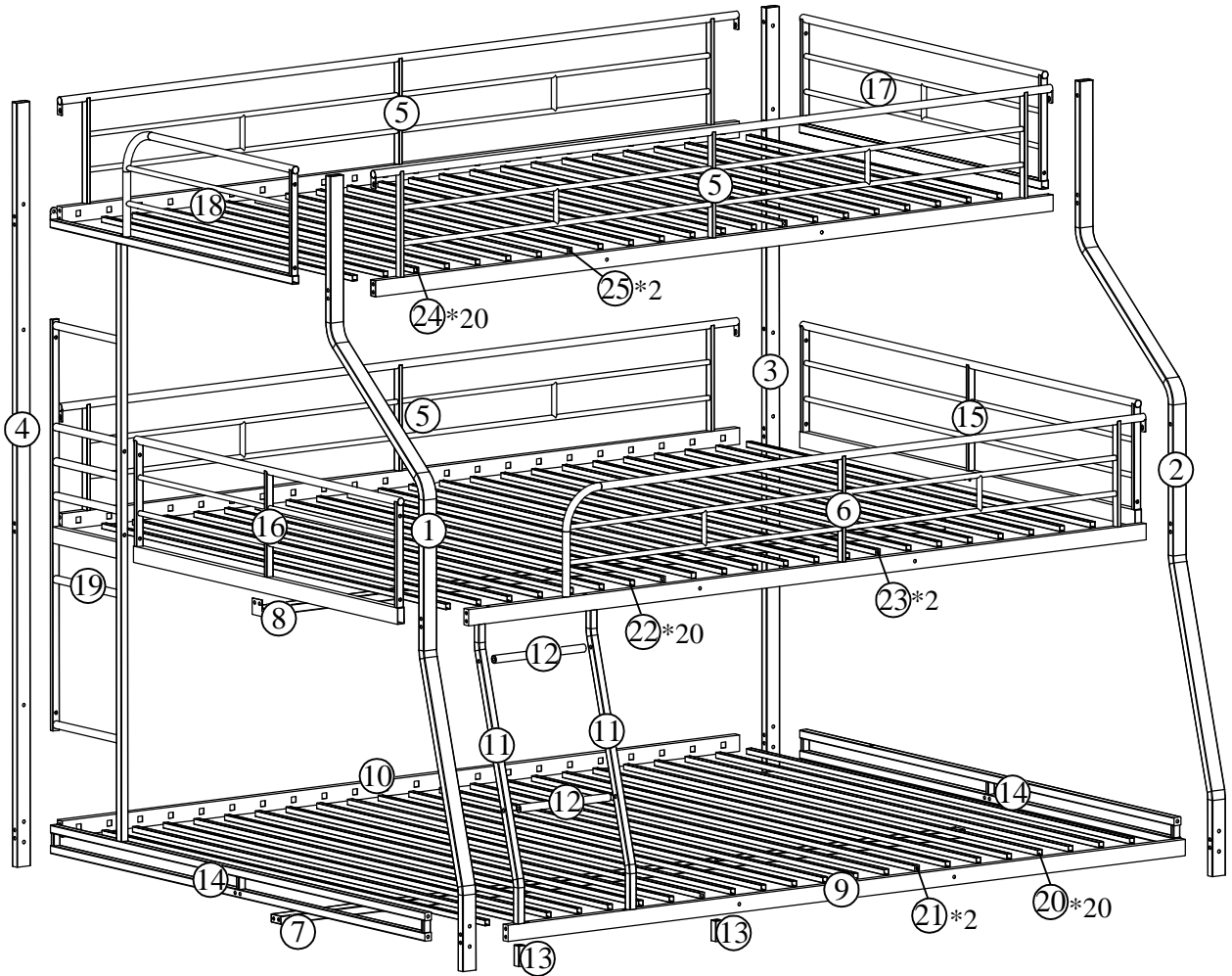

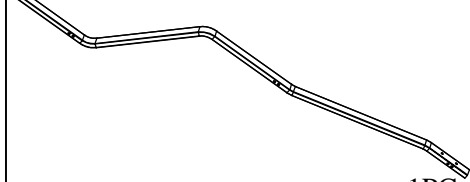
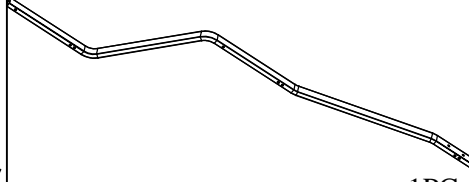
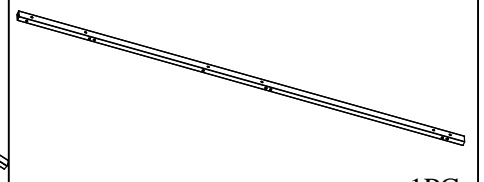
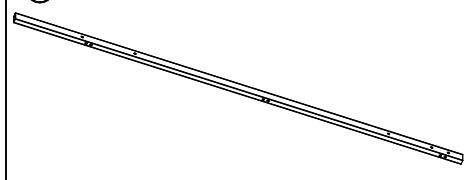
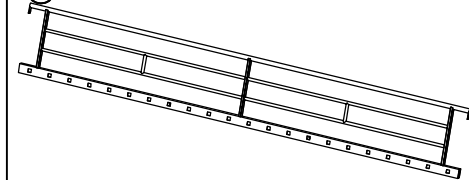
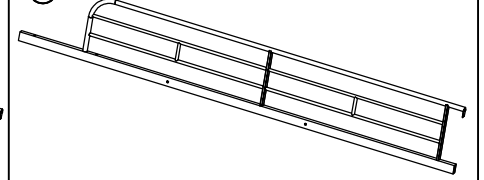
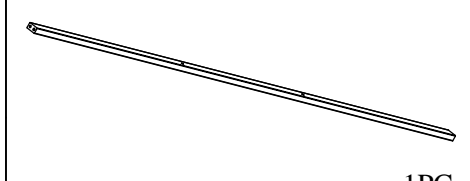
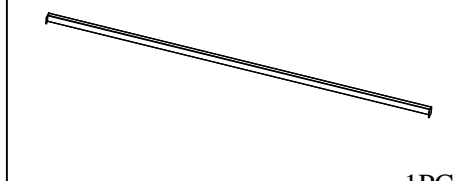
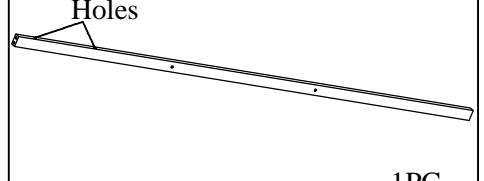
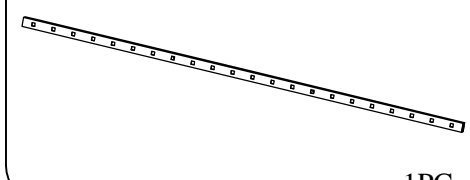
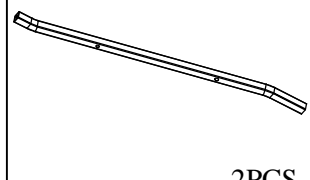
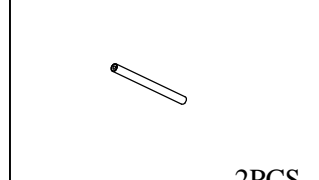
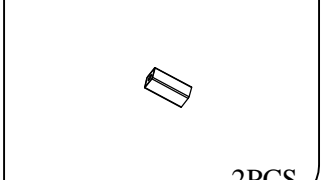

TRIPLE BUNK BED  
 ASSEMBLY INSTRUCTIONS  
 SKU MF287723/287724

PART LIST MF287723



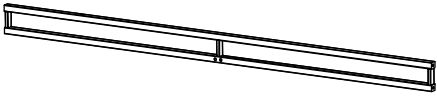
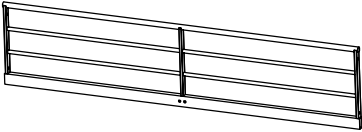
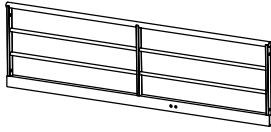
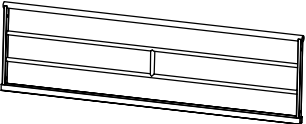
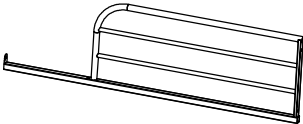
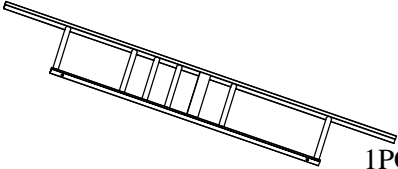
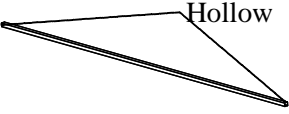
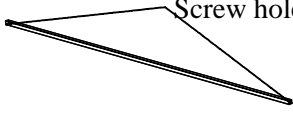
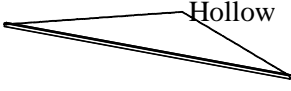
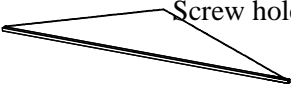

<p>① Post</p>  <p>1PC</p>	<p>② Post</p>  <p>1PC</p>	<p>③ Post</p>  <p>1PC</p>	
<p>④ Post</p>  <p>1PC</p>	<p>⑤ Guard rail</p>  <p>3PCS</p>	<p>⑥ Guard rail</p>  <p>1PC</p>	
<p>⑦ Center brace</p>  <p>1PC</p>	<p>⑧ Center brace</p>  <p>1PC</p>	<p>⑨ Side rail Holes</p>  <p>1PC</p>	
<p>⑩ Side rail</p>  <p>1PC</p>	<p>⑪ Ladder</p>  <p>2PCS</p>	<p>⑫ Ladder</p>  <p>2PCS</p>	<p>⑬ Center post</p>  <p>2PCS</p>

**TRIPLE BUNK BED  
ASSEMBLY INSTRUCTIONS  
SKU MF287723/287724**

**PART LIST MF287724**

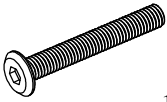
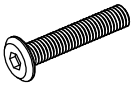
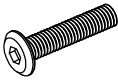
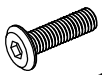
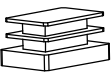
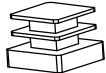
<p>⑭ End guard rail</p>  <p style="text-align: right;">2PCS</p>	<p>⑮ End guard rail</p>  <p style="text-align: right;">1PC</p>	<p>⑯ End guard rail</p>  <p style="text-align: right;">1PC</p>
<p>⑰ End guard rail</p>  <p style="text-align: right;">1PC</p>	<p>⑱ End guard rail</p>  <p style="text-align: right;">1PC</p>	<p>⑲ Ladder</p>  <p style="text-align: right;">1PC</p>
<p>⑳ Slats</p> <p style="text-align: center;">Hollow</p>  <p style="text-align: right;">20PCS</p>	<p>㉑ Slats</p> <p style="text-align: center;">Screw hole</p>  <p style="text-align: right;">2PCS</p>	<p>㉒ Slats</p> <p style="text-align: center;">Hollow</p>  <p style="text-align: right;">20PCS</p>
<p>㉓ Slats</p> <p style="text-align: center;">Screw hole</p>  <p style="text-align: right;">2PCS</p>	<p>㉔ Slats</p> <p style="text-align: center;">Hollow</p>  <p style="text-align: right;">20PCS</p>	<p>㉕ Slats</p> <p style="text-align: center;">Screw hole</p>  <p style="text-align: right;">2PCS</p>

**HARDWARE LIST MF287723**

<p>Ⓐ Bolts</p>  <p style="text-align: right;">1/4"*60 28PCS</p>	<p>Ⓑ Bolts</p>  <p style="text-align: right;">1/4"*40 20PCS</p>	<p>Ⓒ Bolts</p>  <p style="text-align: right;">1/4"*25 16PCS</p>	<p>Ⓓ Bolts</p>  <p style="text-align: right;">1/4"*15 24PCS</p>	
<p>Ⓔ End cap</p>  <p style="text-align: right;">40*20 8PCS</p>	<p>Ⓕ End cap</p>  <p style="text-align: right;">20*20 2PCS</p>	<p>Ⓖ End cap</p>  <p style="text-align: right;">20*10 2PCS</p>	<p>Ⓗ Connect wall</p>   <p style="text-align: right;">1/4"*40 2 SET</p>	<p>Ⓙ Allen key</p>  <p style="text-align: right;">4*59 1PC</p>

This set is included 2 boxes if don't receive full 2 boxes please contact our customer service team.

**TRIPLE BUNK BED  
ASSEMBLY INSTRUCTIONS  
SKU MF287723/287724**

**STEP 1 :**

Following below illustration Assembly Frame # 1. Using hardware #B, #C, #D, #E, #G connect #1 & #4 with #14, #16, #18, #19 to complete Frame #1.

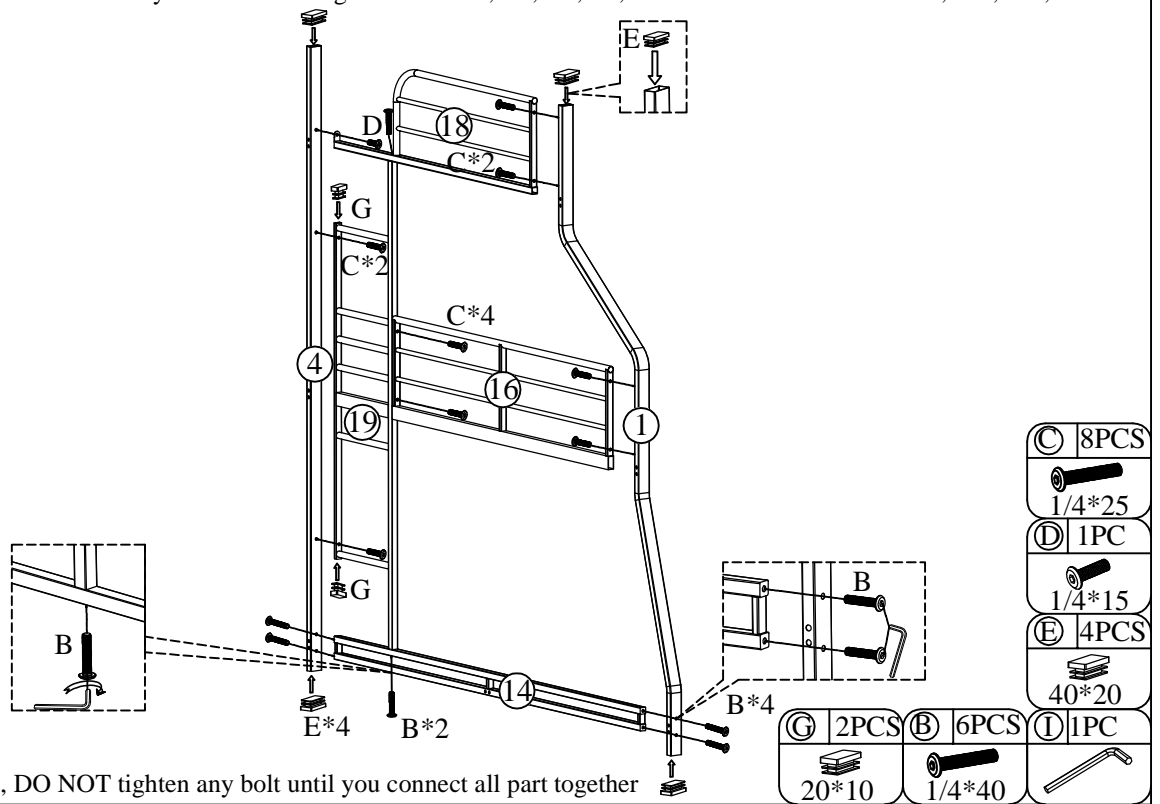

**NOTE:** In this step, DO NOT tighten any bolt until you connect all part together

**STEP 2 :**

Following below illustration Assembly Frame # 2. Using hardware #B, #C, #E connect #2 & #3 with #14, #15, #17 to complete Frame #2.

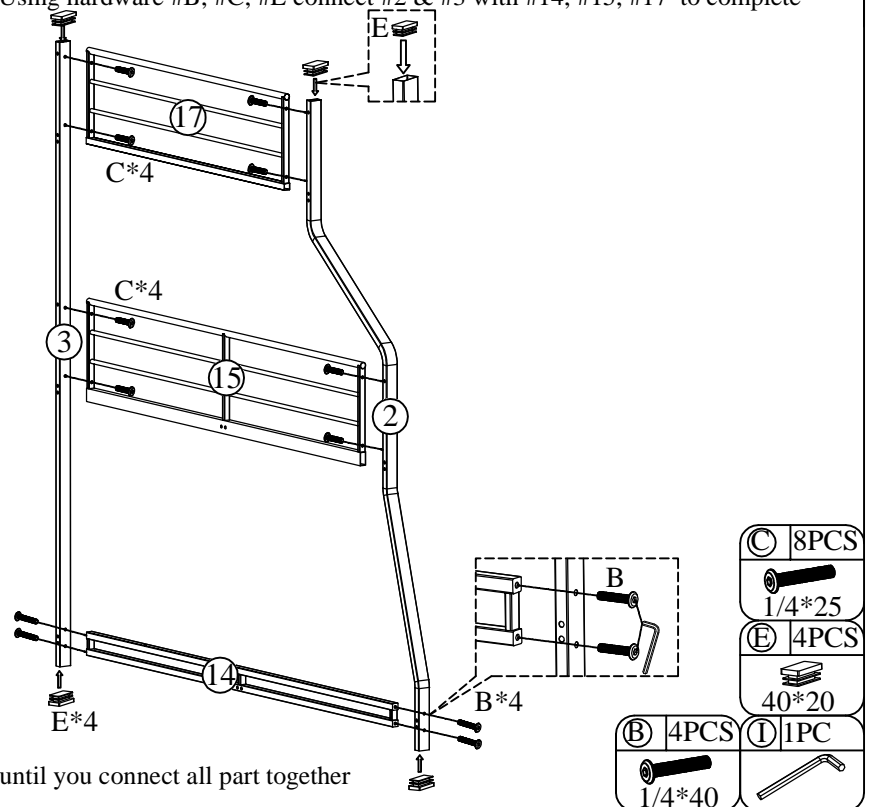

**NOTE:** In this step, DO NOT tighten any bolt until you connect all part together

TRIPLE BUNK BED  
ASSEMBLY INSTRUCTIONS  
SKU MF287723/287724

**STEP 3 :**

Following below illustration Assembly Frame # 3. Using hardware #D connect #9 & #10 with #20, #21 to complete Frame #3.

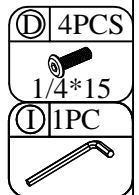
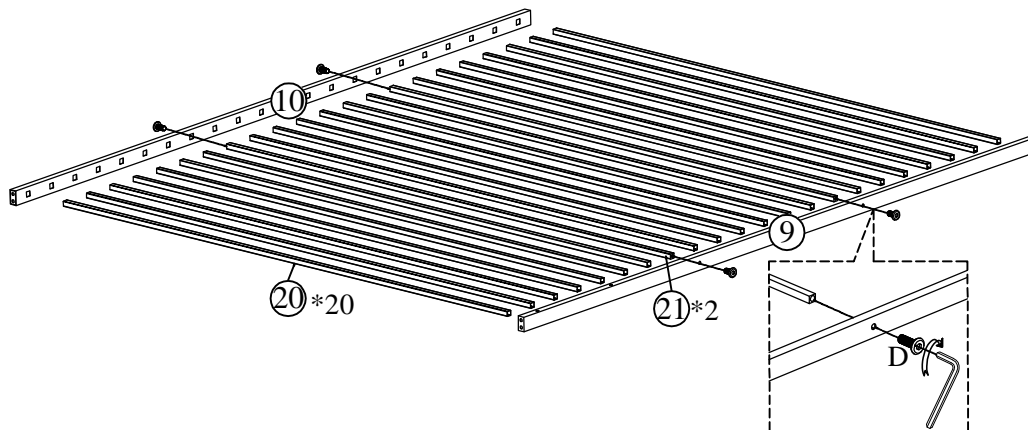

**NOTE:**In this step, DO NOT tighten any bolt until you connect all part together

**STEP 4 :**

Following below illustration Assembly Frame # 4. Using hardware #D connect #5 & #6 with #22, #23 to complete Frame #4.

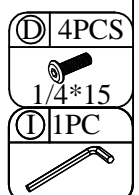
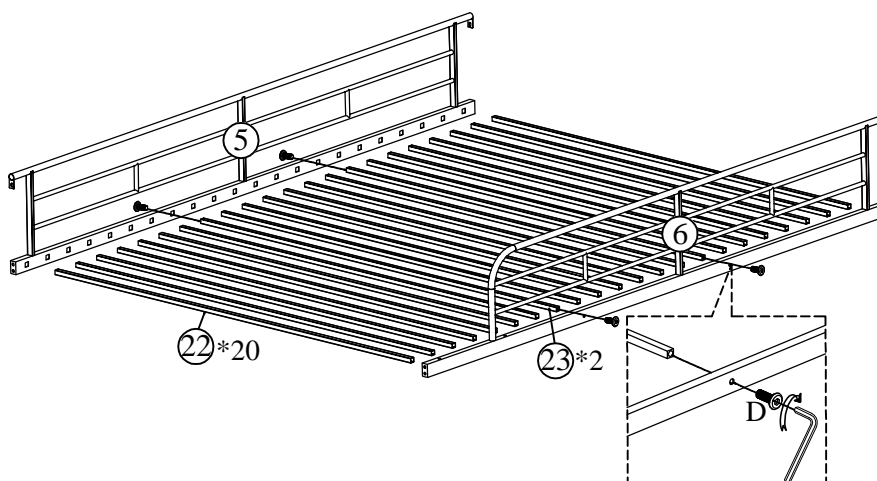

**NOTE:**In this step, DO NOT tighten any bolt until you connect all part together

**TRIPLE BUNK BED  
ASSEMBLY INSTRUCTIONS  
SKU MF287723/287724**

**STEP 5 :**

Following below illustration Assembly Frame # 5. Using hardware #D connect #5 & #5 with #24, #25 to complete Frame #5.

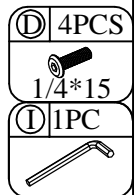
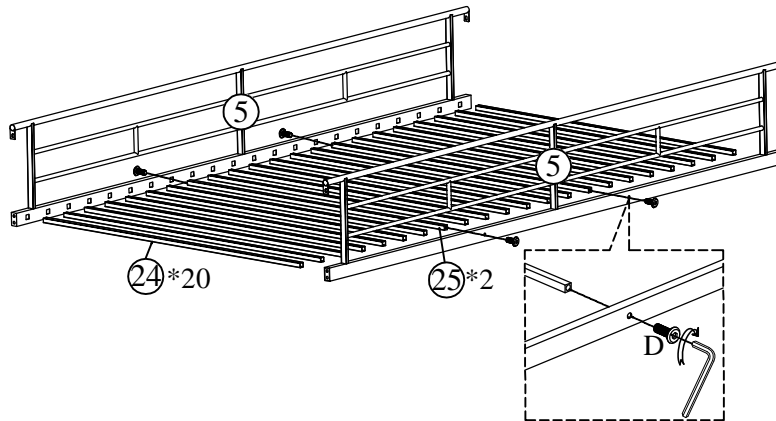

**NOTE:**In this step, DO NOT tighten any bolt until you connect all part together

**STEP 6 :**

Following below illustration Assembly Frame # 6. Using hardware #A & #D connect Frame #1, Frame #2 with Frame #5 to complete Frame #6.

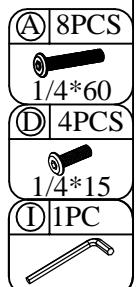
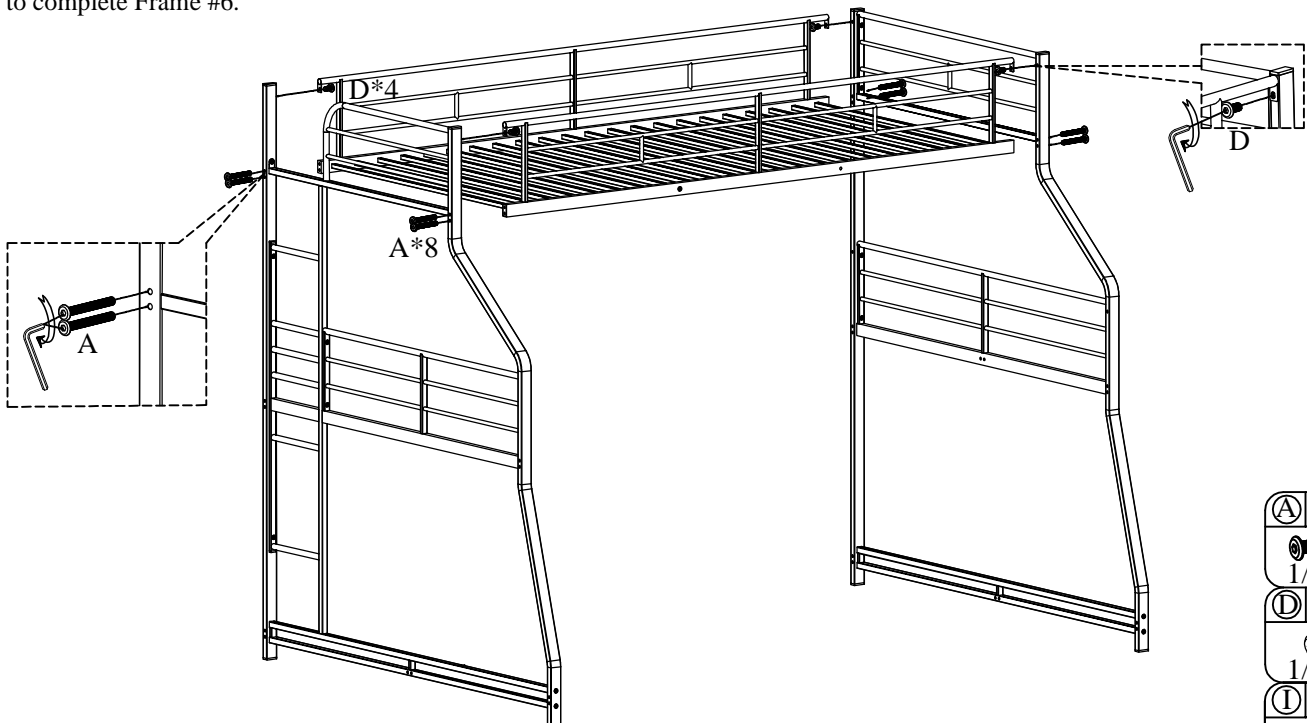

**NOTE:**In this step, DO NOT tighten any bolt until you connect all part together



**TRIPLE BUNK BED  
ASSEMBLY INSTRUCTIONS  
SKU MF287723/287724**

**STEP 7 :**

Following below illustration Assembly Frame # 7. Using hardware #A, #D connect Frame #6 with Frame #4, #8 to complete Frame #7.

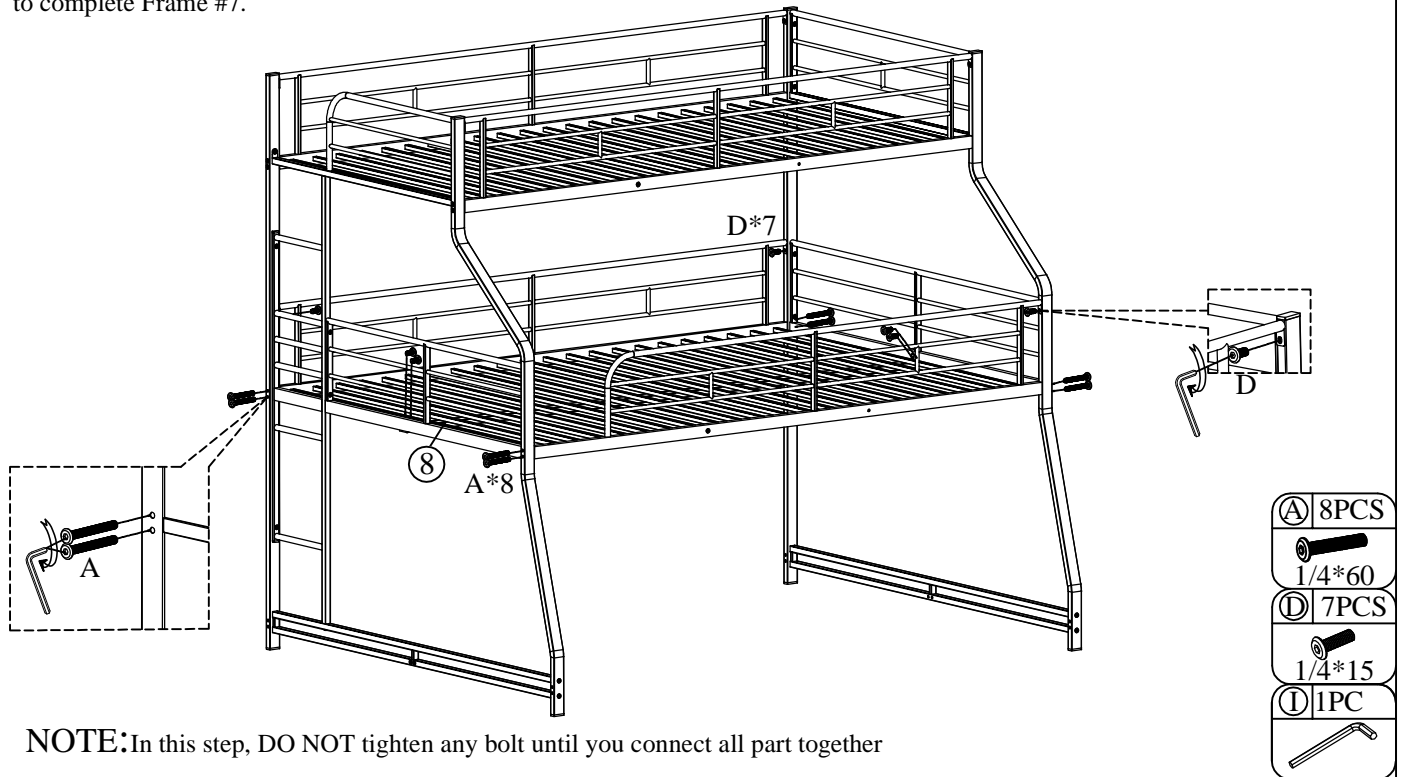

**NOTE:**In this step, DO NOT tighten any bolt until you connect all part together

**STEP 8 :**

Following below illustration Assembly Frame # 8. Using hardware #A, #B, #F connect Frame #7 with Frame #3, #7, #13 to complete Frame #8.

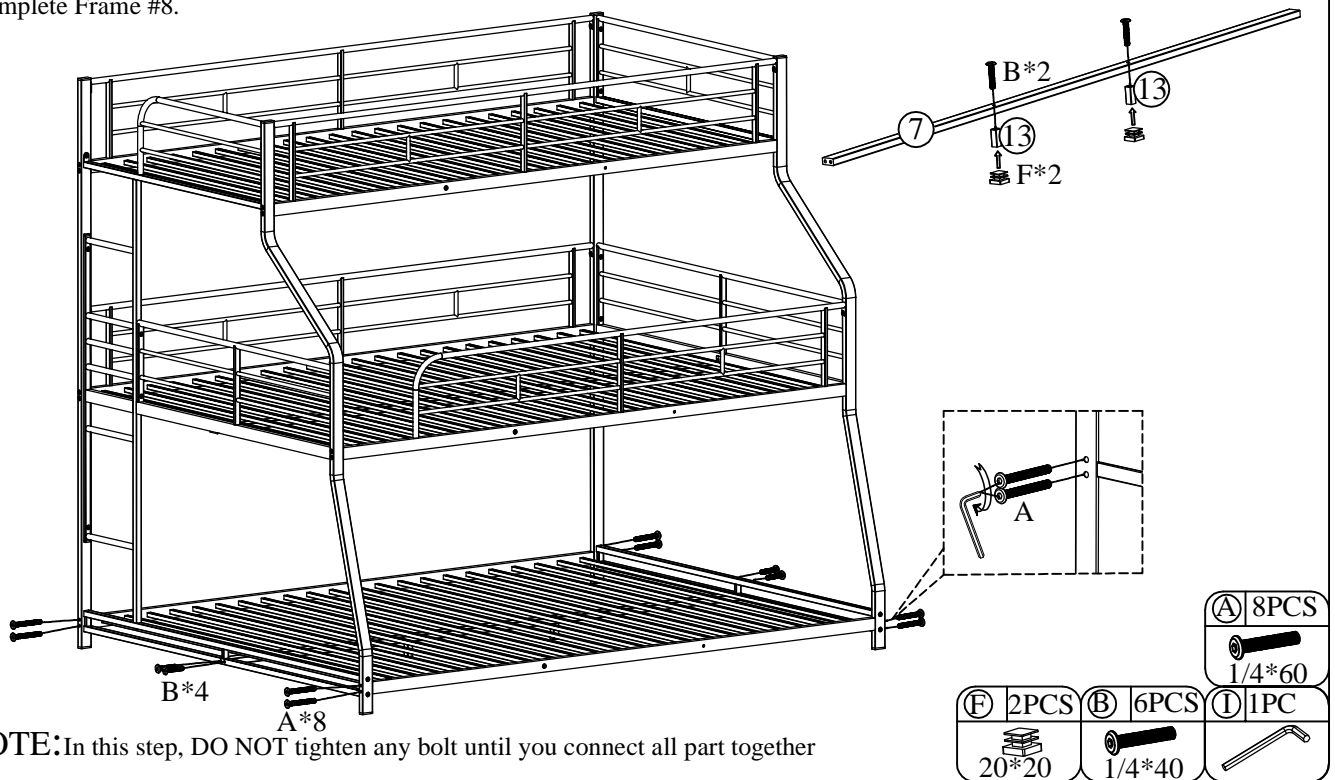

**NOTE:**In this step, DO NOT tighten any bolt until you connect all part together

**TRIPLE BUNK BED  
ASSEMBLY INSTRUCTIONS  
SKU MF287723/287724**

**STEP 9 :**

Following below illustration Assembly Frame # 9.Using hardware #A & #B connect Frame #8 with #11, #12 to complete Frame #9.

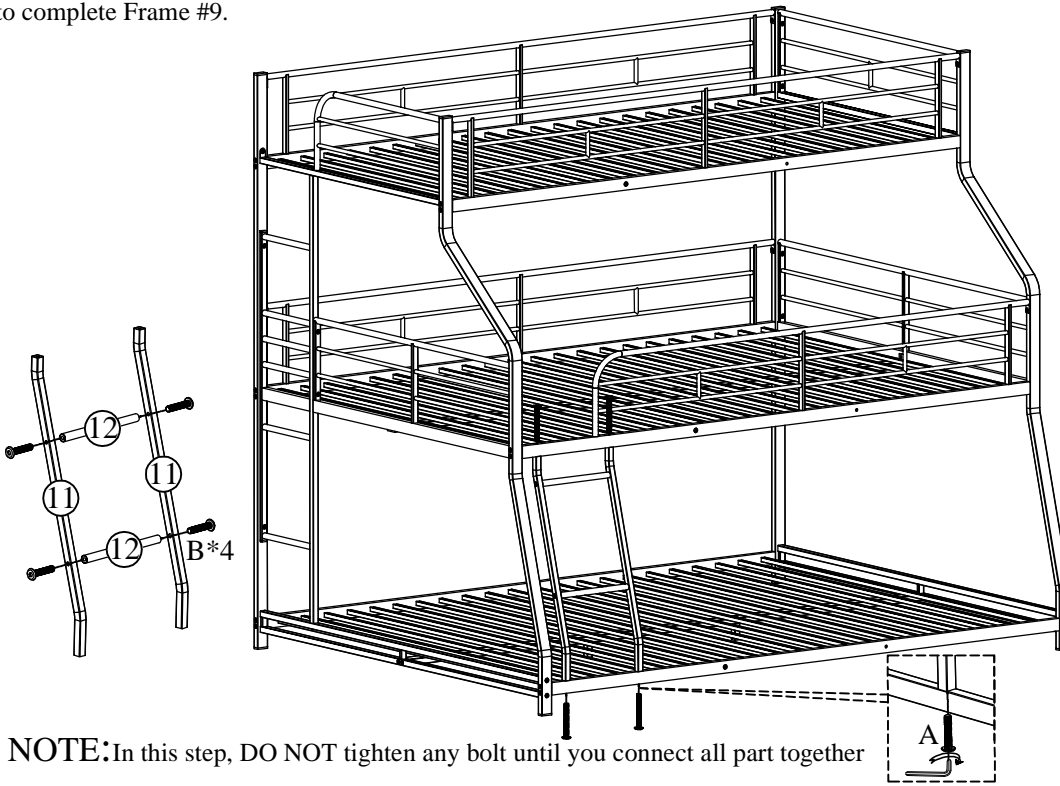

**NOTE:**In this step, DO NOT tighten any bolt until you connect all part together

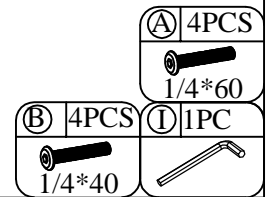

**STEP 10 :**

Following below illustration Assembly Frame # 10.Using hardware #H connect Frame #9 with Wall to complete.

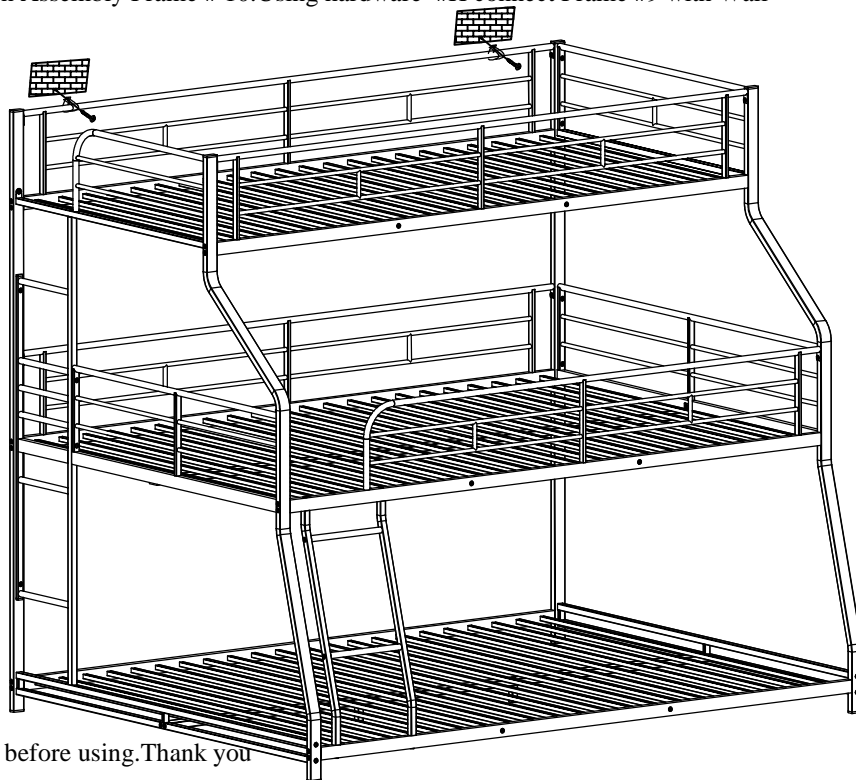

**NOTE:** Tighten all step before using.Thank you

