

TWIN OVER TWIN BUNK BED
ASSEMBLY INSTRUCTIONS
SKU : MF285671

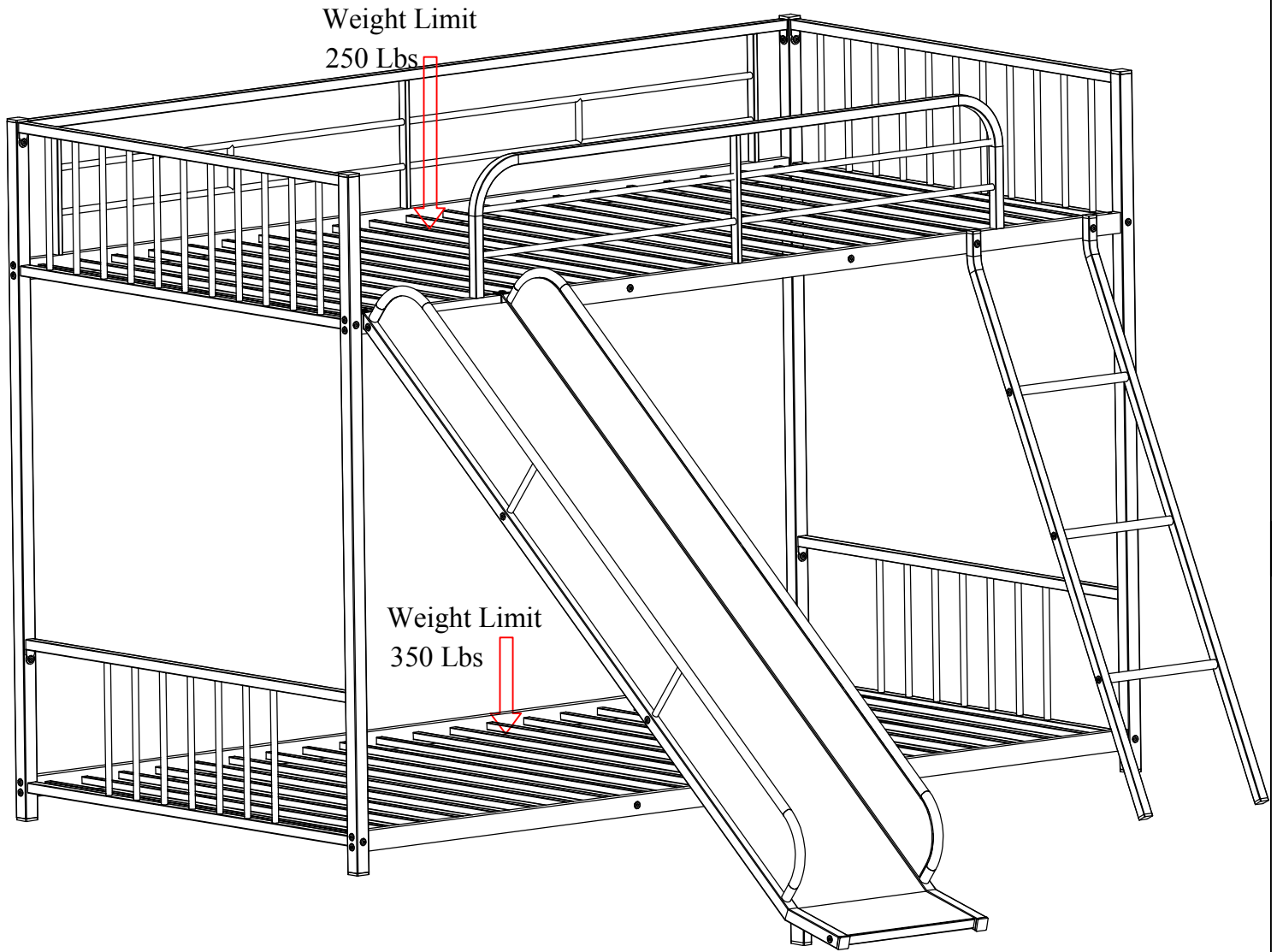

**TWIN OVER TWIN BUNK BED
ASSEMBLY INSTRUCTIONS
SKU : MF285671**

SAFETY WARNINGS AND GENERAL NOTES:

1. Follow the information on the warnings on the bunk bed end structure and on the carton. Do not remove the warning label from the bed.
2. Always use the recommended size mattress on mattress support, or both, to help prevent the likelihood of entrapment or falls.
3. Do not allow children under 6 years of age to use the upper bunk.
4. Periodically check and ensure the guardrail, ladder and other components are in their proper position, free from damage, and all connectors are tight.
5. Do not allow horseplay on or under beds.
6. Always prohibit jumping on the bed.
7. Prohibit more than one person on upper bunk.
8. Always use the ladder for entering and leaving the upper bunk.
9. Do not use substitute parts. Contact the manufacturer or dealer for replacement parts.
10. Use of a night-tight may provide added safety precaution for a child using the upper bunk.
11. Always use guardrails on both long sides of the upper bunk.
12. If the bunk bed will be placed next to a wall, the guardrail that runs the full length of the bed should be placed against the wall to prevent entrapment between the bed and the wall.

The use of water or sleep flotation mattresses is prohibited.

13. **STRANGULATION HAZARD-** Never attach or hang items to any part of the bunk bed that are not designed for use with the bed; for example, but not limited to, hook, belts and jump ropes.
14. Keep these instructions for future reference.
15. We recommend assembling your bunk bed on the shipping carton to protect your floor or carpet.
16. Be certain all staples are out of the box before beginning assembly on the shipping carton.

17. USE ONLY MATTRESSES WHICH ARE AS THE TABLE BELOW ON UPPER AND ON LOWER BUNKS.

Upper bunk (bunk bed and tribed included)

Bed type	Length	Width	Thickness
Twin	74" – 75"	38 ½"	6" max

Lower bunk

Bed type	Length	Width	Thickness
Twin	74" – 75"	38 ½"	8"

18. SURFACE OF MATTRESS MUST BE AT LEAST 5" (127MM) BELOW THE UPPER EDGE OF GUARDRAILS.

19. Replacement Parts:

Replacement Parts, including additional guardrails, may be obtained from any of our (GIGACLOUD TECHNOLOGY(USA) INC. 18961 ARENTH AVENUE, CITY OF INDUSTRY, CA, 91748) dealers.

TWIN OVER TWIN BUNK BED
ASSEMBLY INSTRUCTIONS
SKU : MF285671

1. At the beginning :

Tighten all hardware.

Check metal parts for rust. If found, sand and repaint using a non-lead-based paint meeting the requirements of 16 CFR 1303.

Check all wood members for deterioration and splinters. Sand down splinters and replace deteriorating wood members.

Rake and check depth of loose fill protective surfacing materials to prevent compaction and to maintain appropriate depth. Replace as necessary.

2. Twice a month

Tighten all hardware.

Rake and check depth of loose fill protective surfacing materials to prevent compaction and to maintain appropriate depth. Replace as necessary.

3. Owners shall be responsible for maintaining the legibility of the warning labels.

4. Disposal Instructions-

There shall be instructions advising the owner to disassemble and dispose of the playground equipment in such a way that no unreasonable hazards will exist at the time the playground equipment is discarded.

5. The instructions shall also include the information found in Section 4 of the United States Consumer Product Safety Commission's (USCPSC) Outdoor Home Playground Safety Handbook or specific surfacing guidelines for the product consistent with the USCPSC Handbook. A copy of this section may be found in Appendix X2.

6. Observing the following statements and warnings reduces the likelihood of serious or fatal injury.

7. Specifying the number and weight of occupants that may safely use the equipment singly or simultaneously,

8. Recommending on-site adult supervision for children of all ages,

9. Warning the owner to instruct children not to use the equipment in a manner other than intended,

10. Warning the owner to instruct children not to get off equipment while it is in motion,

11. Warning the owner not to allow children to wear inappropriate items, such as but not limited to, loose fitting clothing, hood and neck drawstrings, scarves, cord-connected items, capes and ponchos. These items can cause death by strangulation.

12. Warning the owner to instruct children not to climb when the equipment is wet.

13. Warning the owner to instruct children not to attach items to the playground equipment that are not specifically designed for use with the equipment, such as, but not limited to, jump ropes, clothesline, pet leashes, cables and chain as they may cause a strangulation hazard

14. Warning the owner to instruct children to remove their bike or other sports helmet before playing on the playground equipment.

15. Warning the owner to dress children with well-fitting and full foot enclosing footwear. Examples of inappropriate footwear are clogs, flip flops, and sandals.

16. Place the equipment on level ground, not less than 6 ft (1.8 m) from any structure or obstruction such as a fence, garage, house, overhanging branches, laundry lines, or electrical wires

17. Do not install home playground equipment over concrete, asphalt, packed earth, grass, carpet, or any other hard surface. A fall onto a hard surface can result in serious injury or death to the equipment user

18. To prevent serious injury, cautionary statements shall be included which warn that children must not use the equipment until properly installed.

TWIN OVER TWIN BUNK BED
ASSEMBLY INSTRUCTIONS
SKU : MF285671

DETAIL VIEW

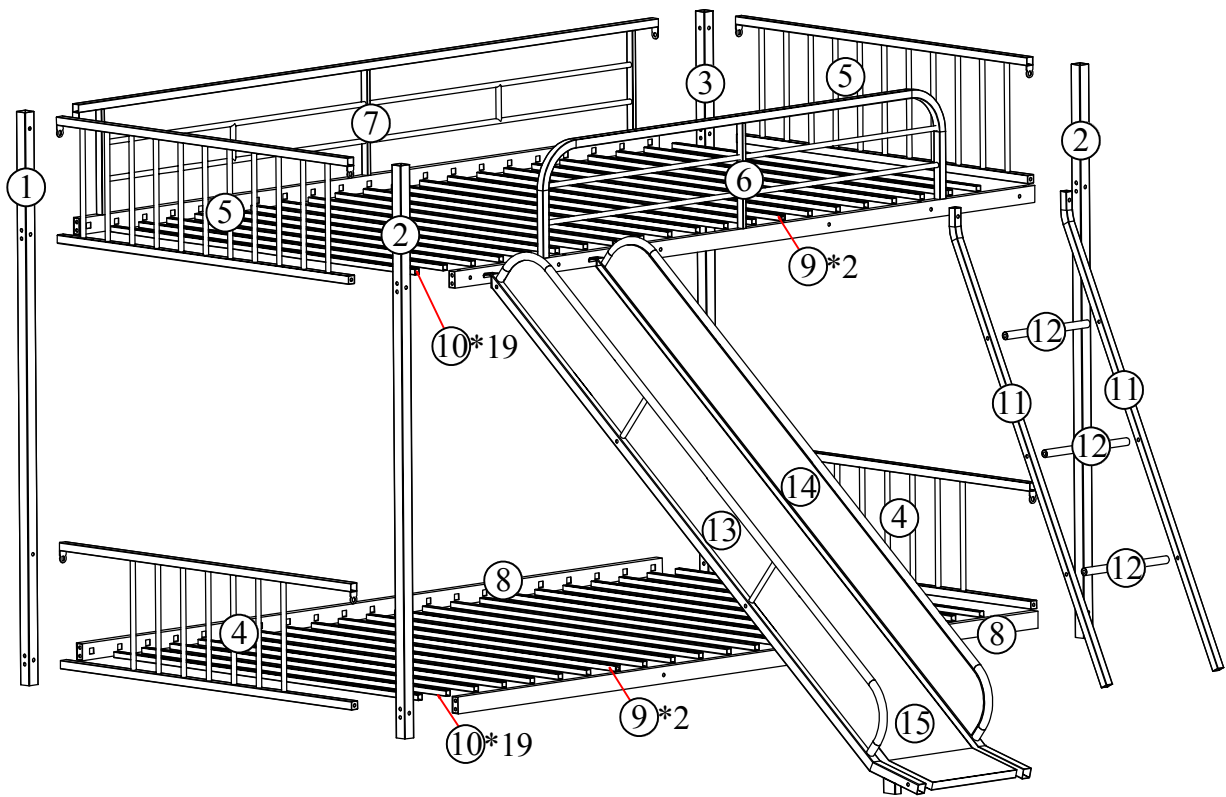

TWIN OVER TWIN BUNK BED
 ASSEMBLY INSTRUCTIONS
 SKU : MF285671

PART LIST MF285671

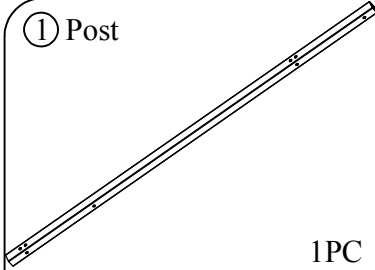
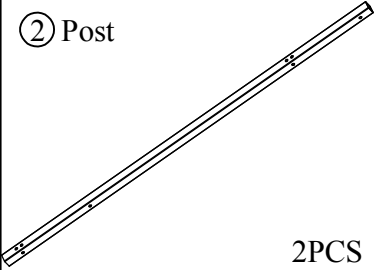
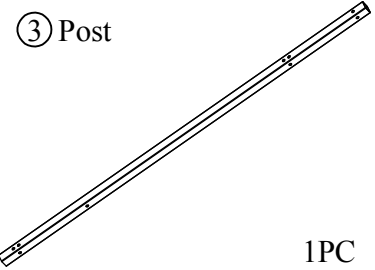
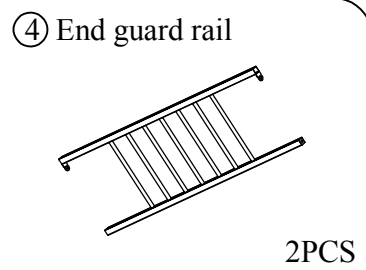
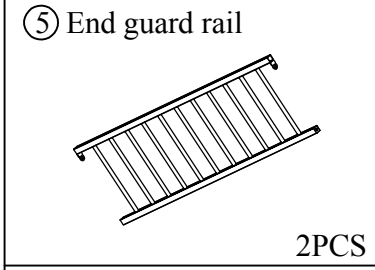
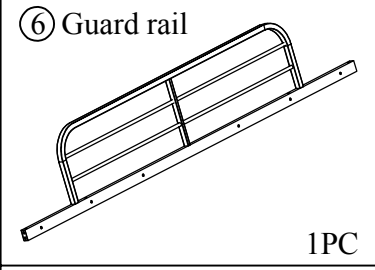
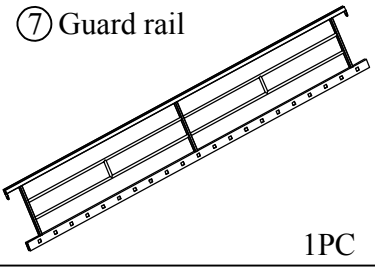
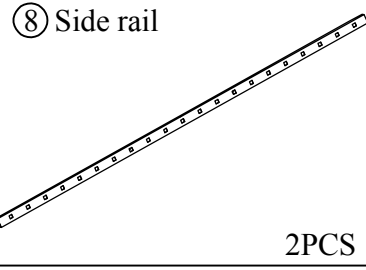
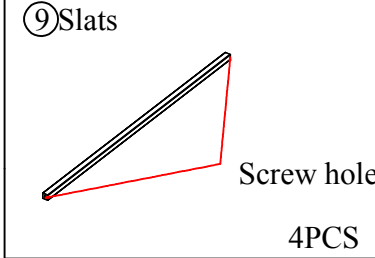
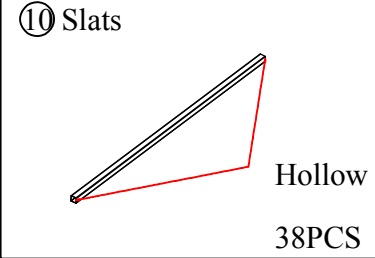
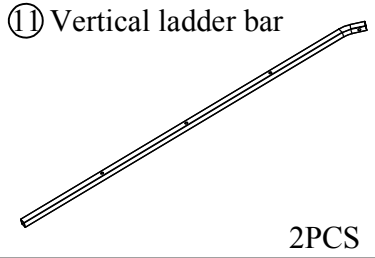
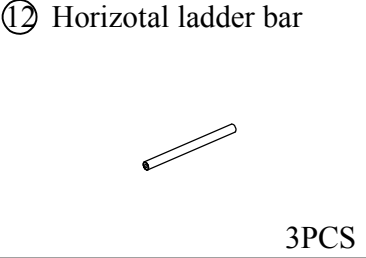
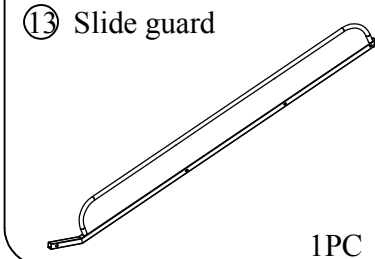
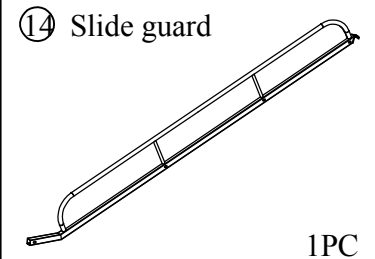
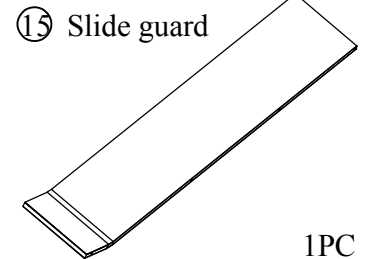
① Post  1PC	② Post  2PCS	③ Post  1PC	④ End guard rail  2PCS
⑤ End guard rail  2PCS	⑥ Guard rail  1PC	⑦ Guard rail  1PC	⑧ Side rail  2PCS
⑨ Slats  Screw hole 4PCS	⑩ Slats  Hollow 38PCS	⑪ Vertical ladder bar  2PCS	⑫ Horizontal ladder bar  3PCS
⑬ Slide guard  1PC	⑭ Slide guard  1PC	⑮ Slide guard  1PC	

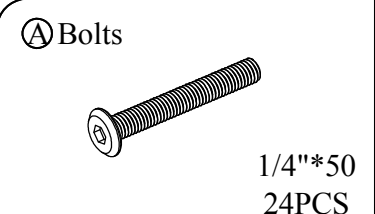
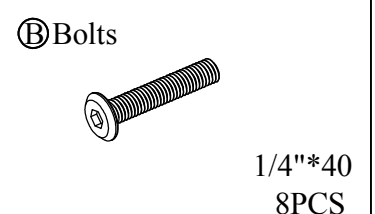
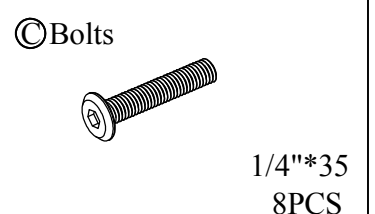
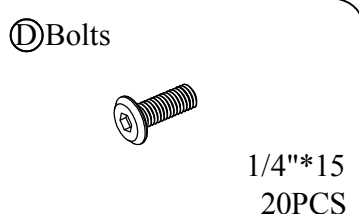
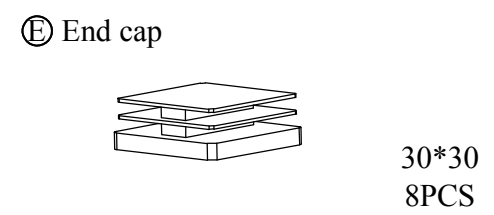
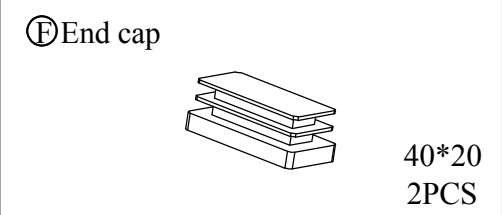
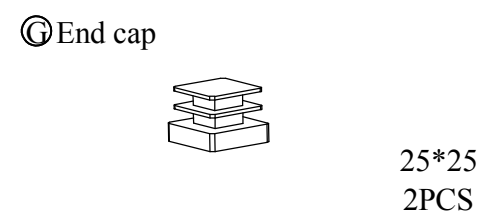
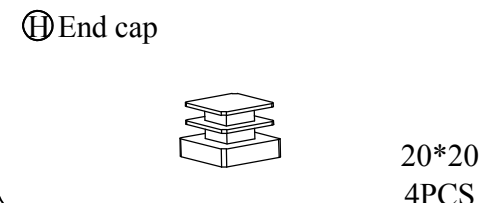
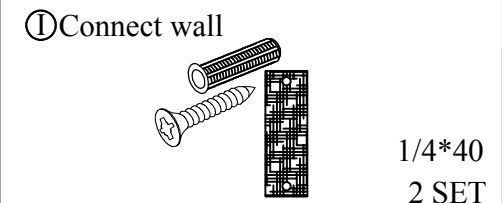
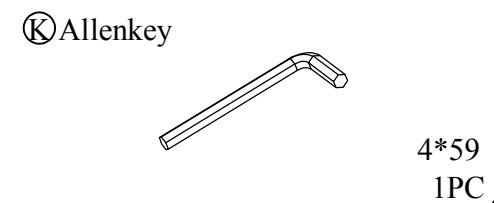

HARDWARE LIST MF285671

Ⓐ Bolts  1/4"*50 24PCS	Ⓑ Bolts  1/4"*40 8PCS	Ⓒ Bolts  1/4"*35 8PCS	Ⓓ Bolts  1/4"*15 20PCS
Ⓔ End cap  30*30 8PCS	Ⓕ End cap  40*20 2PCS	Ⓖ End cap  25*25 2PCS	
Ⓗ End cap  20*20 4PCS	Ⓖ Connect wall  1/4*40 2 SET	Ⓚ Allenkey  4*59 1PC	

TWIN OVER TWIN BUNK BED
 ASSEMBLY INSTRUCTIONS
 SKU : MF285671

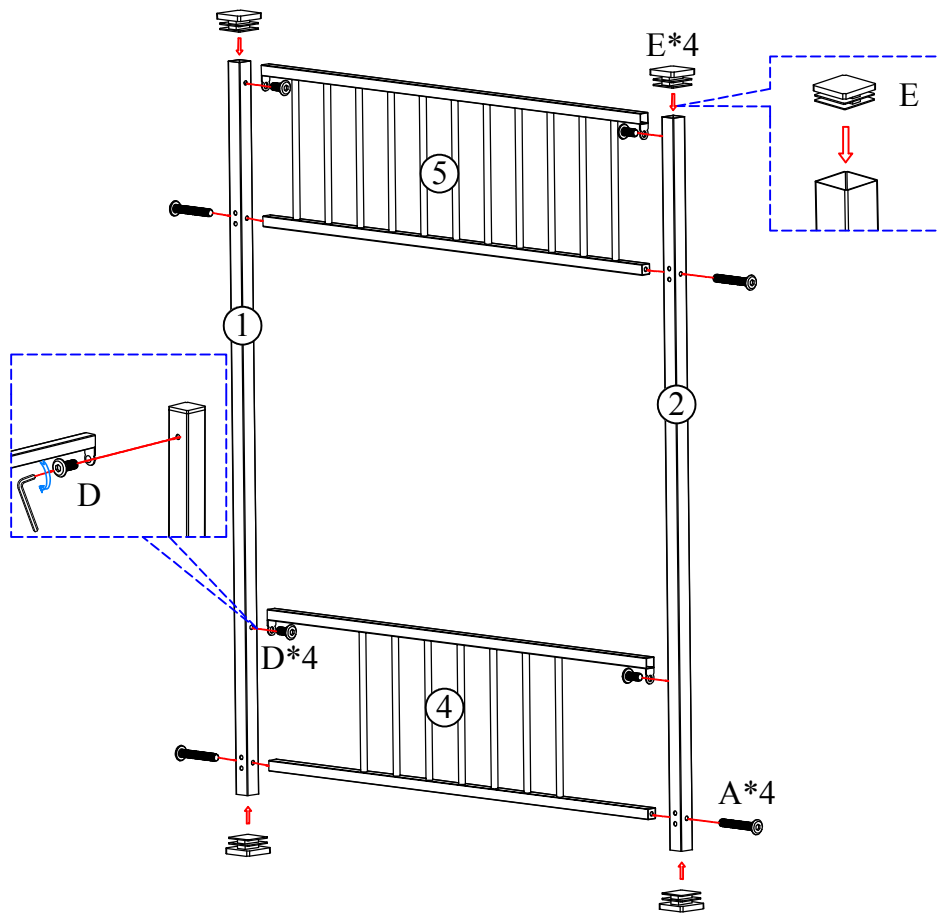
STEP 1 : Following below illustration Assembly Frame # 1.Using hardware #A, #D ,#E connect #1, #2 with #4, #5 to complete Frame #1.

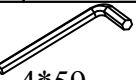

(A)	4PCS
	1/4*50
(D)	4PCS
	1/4*15
(E)	4PCS
	30*30
(K)	1PC
	4*59

NOTE:In this step, DO NOT tighten any bolt until you connect all part together

TWIN OVER TWIN BUNK BED
 ASSEMBLY INSTRUCTIONS
 SKU : MF285671

STEP 2 : Following below illustration Assembly Frame # 2. Using hardware #A, #D ,#E connect #2, #3 with #4, #5 to complete Frame #2.

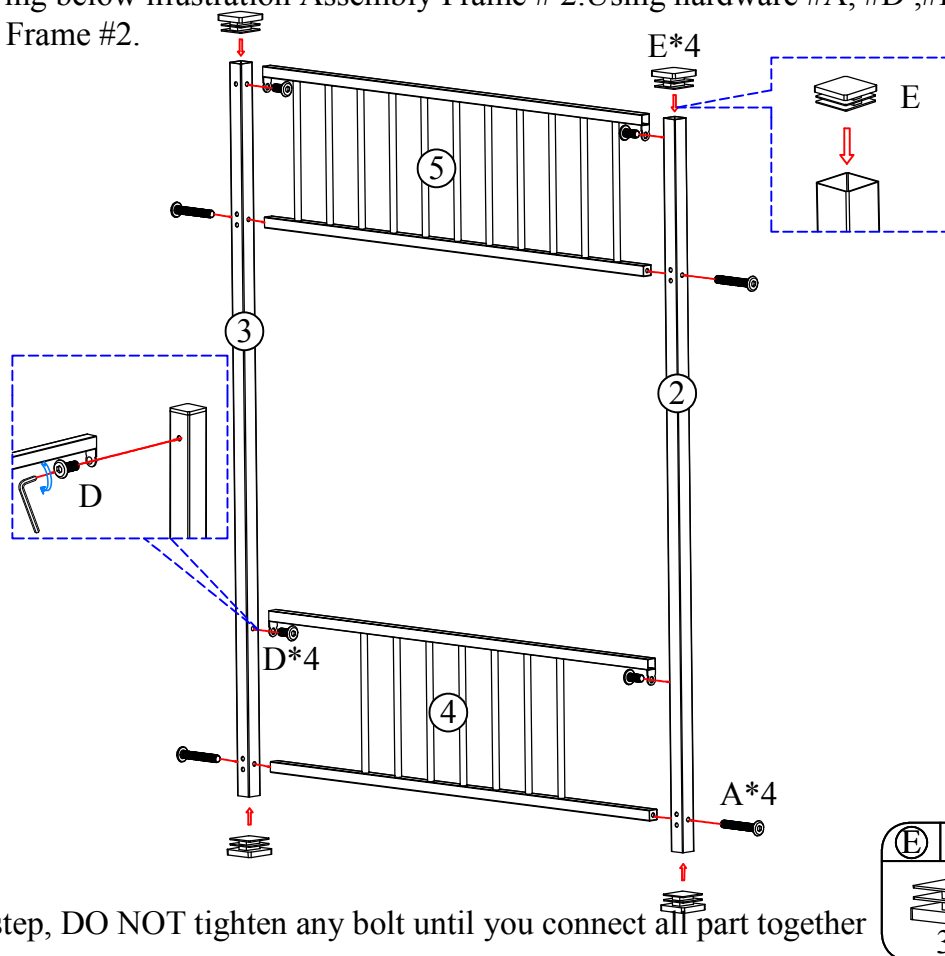

NOTE:In this step, DO NOT tighten any bolt until you connect all part together

STEP 3 : Following below illustration Assembly Frame #3. Using hardware #D connect #6, #7 with #9, #10 to complete Frame #3.

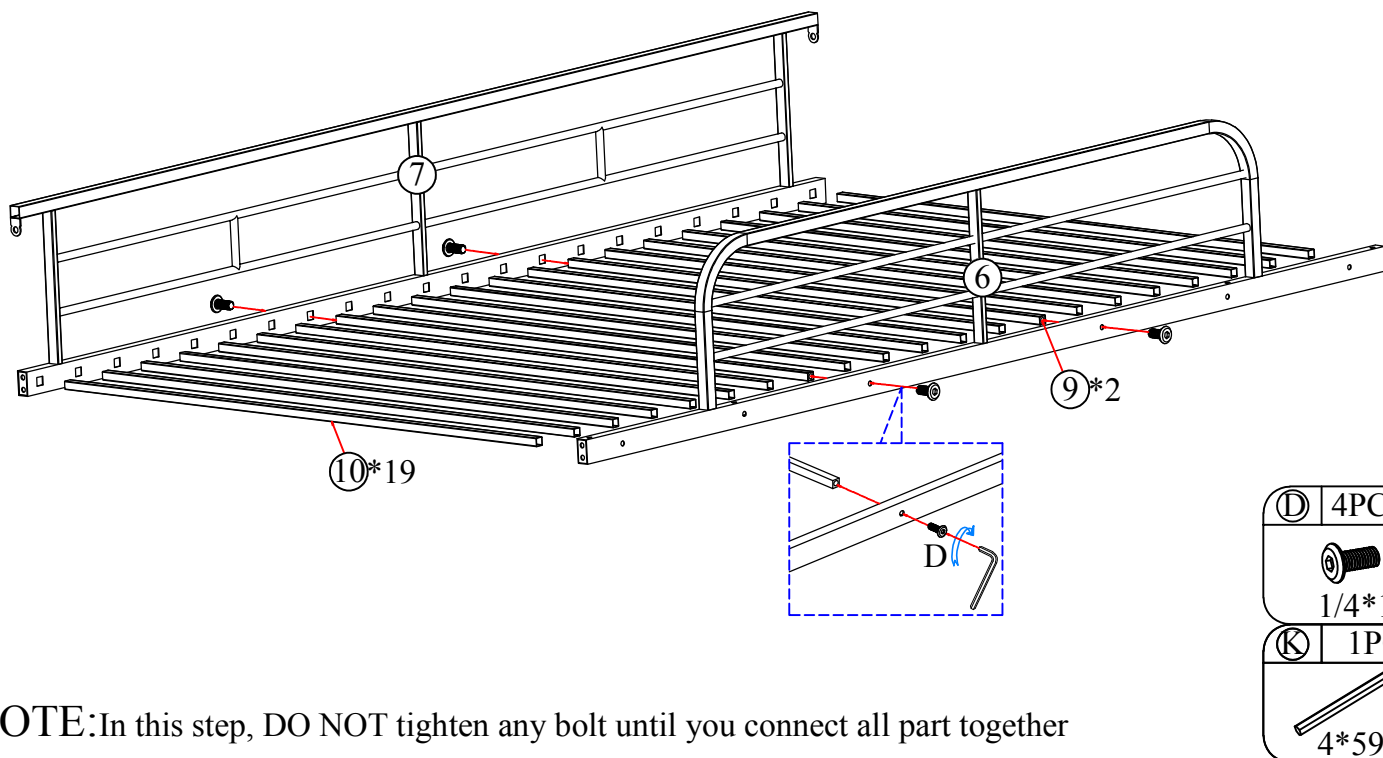



NOTE:In this step, DO NOT tighten any bolt until you connect all part together

**TWIN OVER TWIN BUNK BED
ASSEMBLY INSTRUCTIONS
SKU : MF285671**

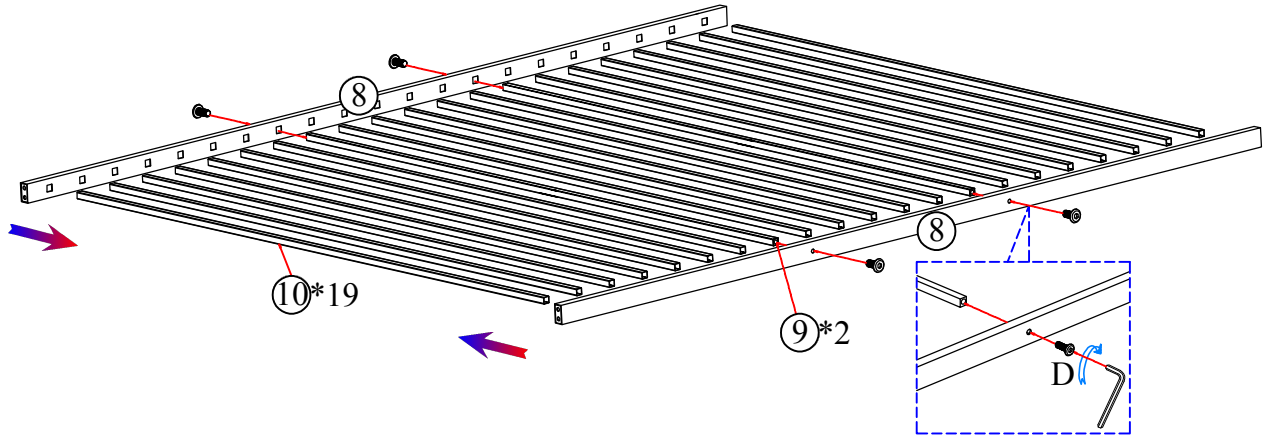
STEP 4 : Following below illustration Assembly Frame #4. Using hardware #D connect #8 with #9, #10 to complete Frame #4.





ⓓ	4PCS
	1/4*15
Ⓚ	1PC
	4*59

NOTE:In this step, DO NOT tighten any bolt until you connect all part together

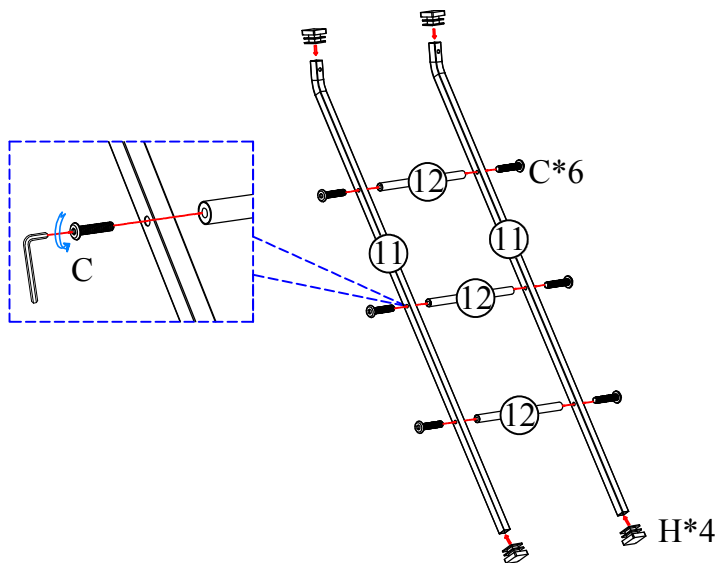
STEP 5 : Following below illustration Assembly Frame #5. Using hardware #C, #H connect #11 with #12 to complete Frame #5.







Ⓒ	6PCS
	1/4*35
ⓓ	4PCS
	20*20
Ⓚ	1PC
	4*59

NOTE:In this step, DO NOT tighten any bolt until you connect all part together

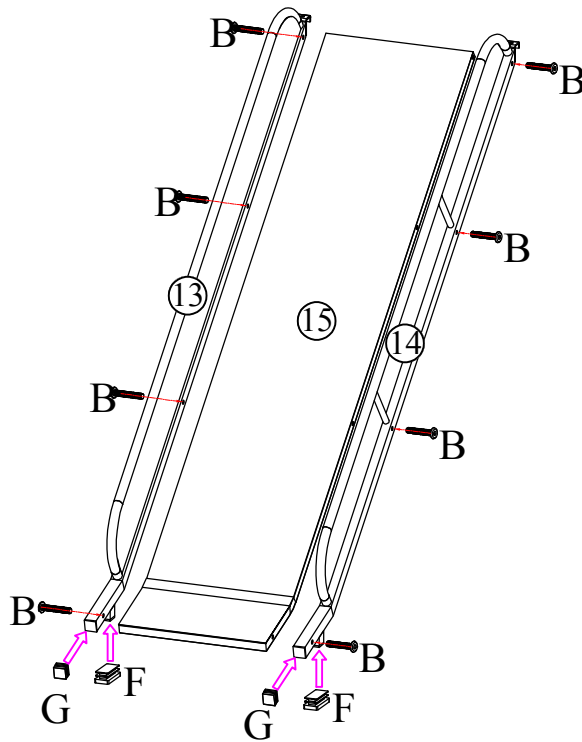
TWIN OVER TWIN BUNK BED
 ASSEMBLY INSTRUCTIONS
 SKU : MF285671

STEP 6 : Following below illustration Assembly Frame #6. Using hardware #B, #F, #G connect #13 with #14 to complete Frame #6.

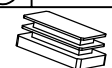



(B)	8PCS
	
1/4*40	
(F)	2PCS
	
40*20	
(G)	2PCS
	
25*25	
(K)	1PC
	
4*59	

NOTE:In this step, DO NOT tighten any bolt until you connect all part together

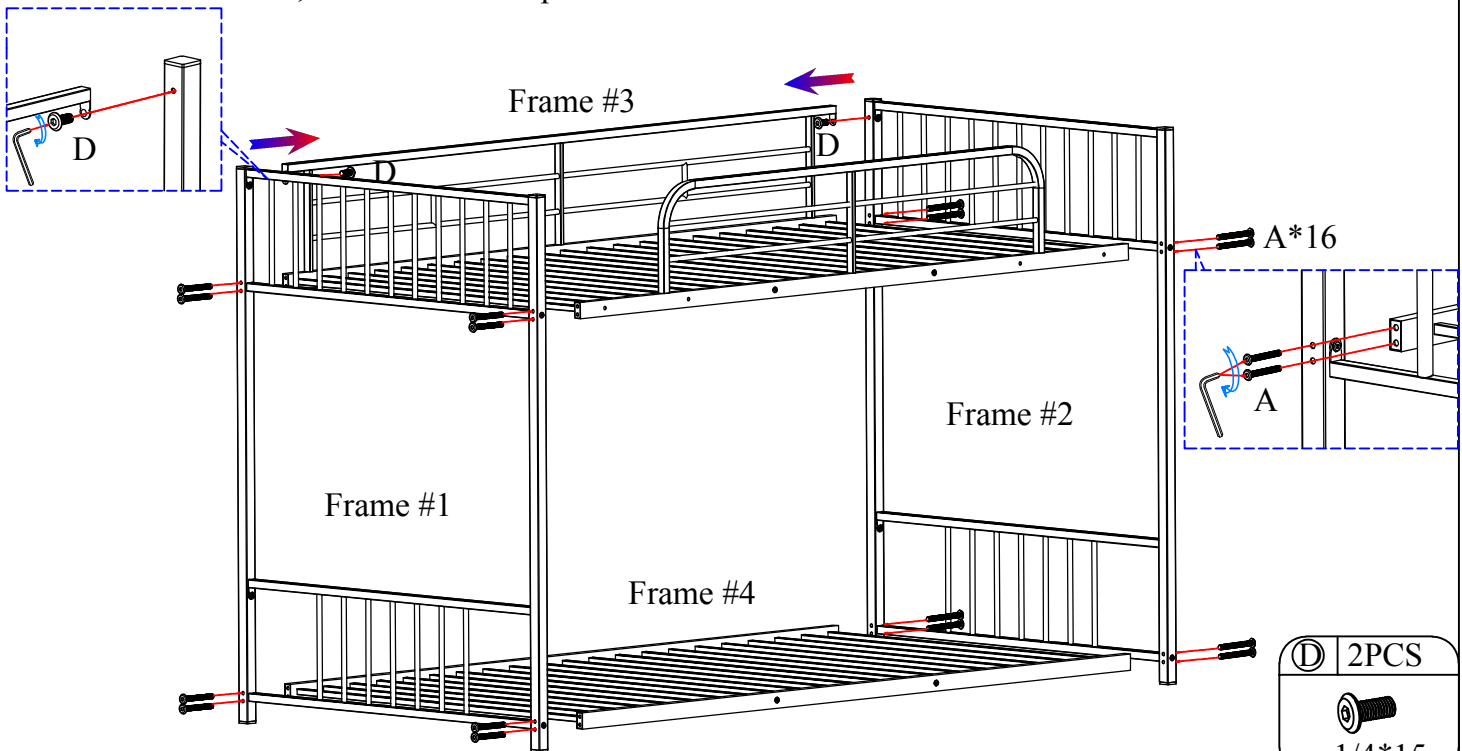
STEP 7 : Following below illustration Assembly Frame #7. Using hardware #A, #D connect Frame #1, Frame #2 with Frame #3, Frame #4 to complete Frame #7.







(D)	2PCS
	
1/4*15	
(A)	16PCS
	
1/4*50	
(K)	1PC
	
4*59	

NOTE:In this step, DO NOT tighten any bolt until you connect all part together

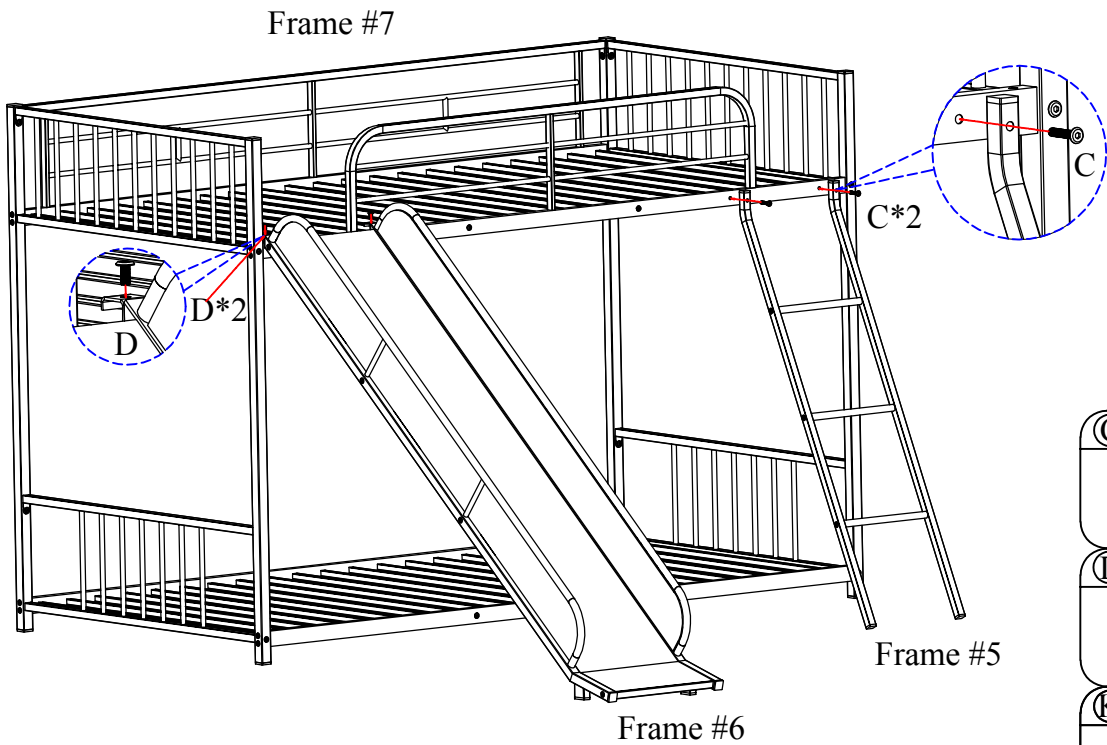
TWIN OVER TWIN BUNK BED
 ASSEMBLY INSTRUCTIONS
 SKU : MF285671

STEP 8 : Following below illustration Assembly Frame #8. Using hardware #C, #D connect Frame #7 with Frame #5, Frame #6 to complete Frame #8.





Ⓒ	2PCS
	1/4*35
Ⓓ	2PCS
	1/4*15
Ⓚ	1PC
	4*59

NOTE: In this step, DO NOT tighten any bolt until you connect all part together

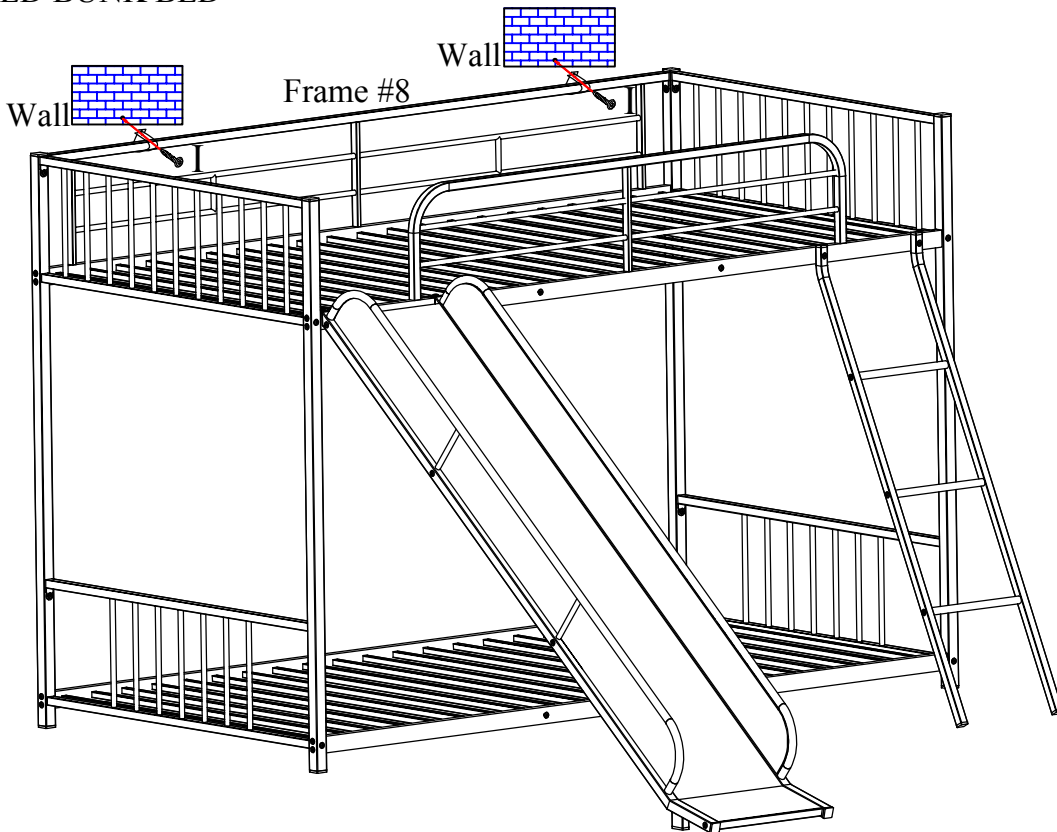
STEP 9 : Following below illustration Assembly Frame #9. Using hardware #I connect Frame #8 with Wall to complete. COMPLETED BUNK BED



Ⓘ	2 SET
	
Ⓚ	1PC
	4*59

NOTE: Tighten all step before using. Thank you.