

# ASSEMBLY INSTRUCTION

SKU CODE: (WF296300)

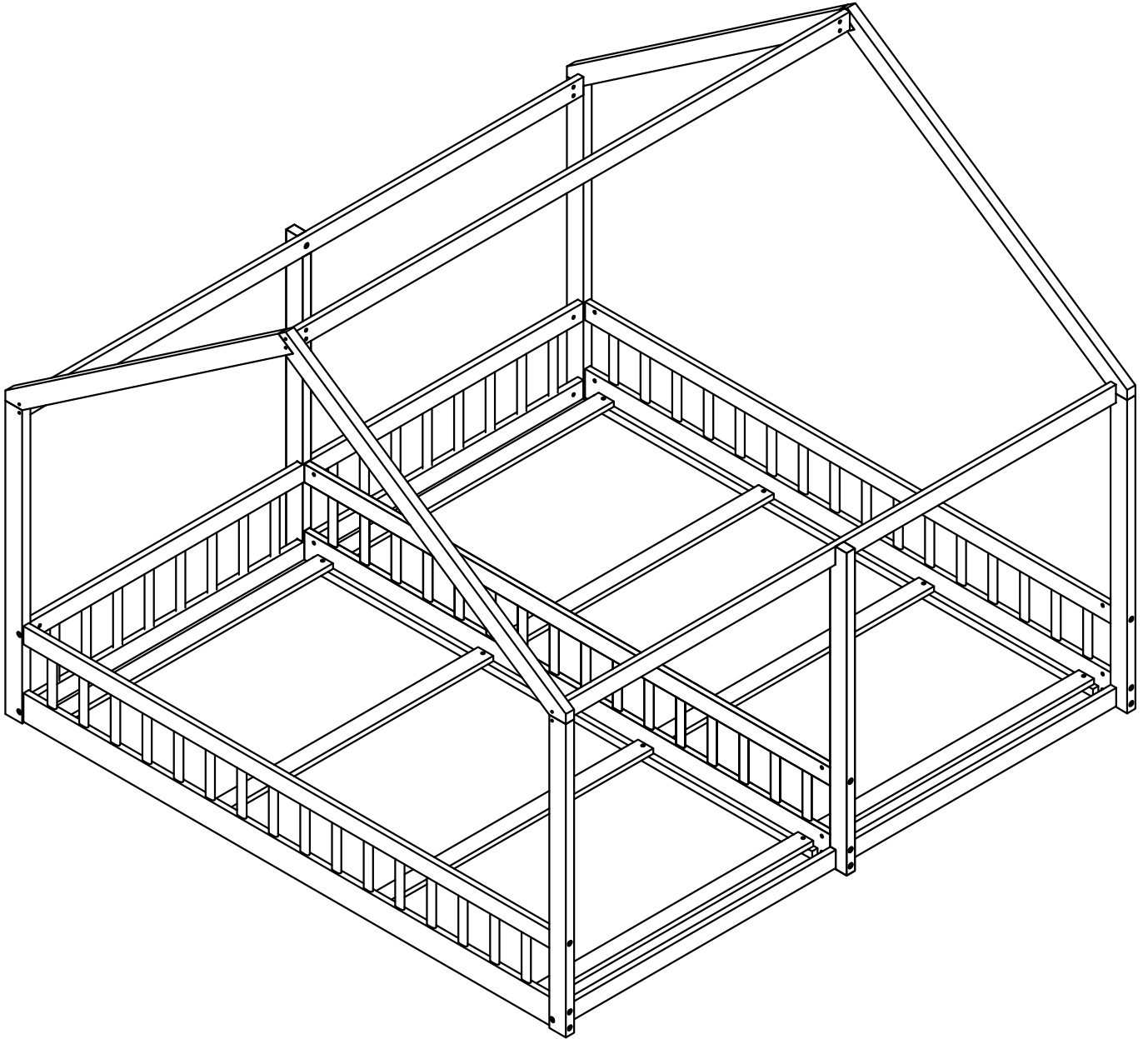

## **SAFETY WARNINGS AND GENERAL NOTES:**

1. Do not use substitute parts. Contact the manufacturer or dealer for replacement parts.
2. Keep these instructions for future reference.
3. We recommend assembling your bed on the shipping carton to protect your floor or carpet.
4. Be certain all staples are out of the box before beginning assembly on the shipping carton.







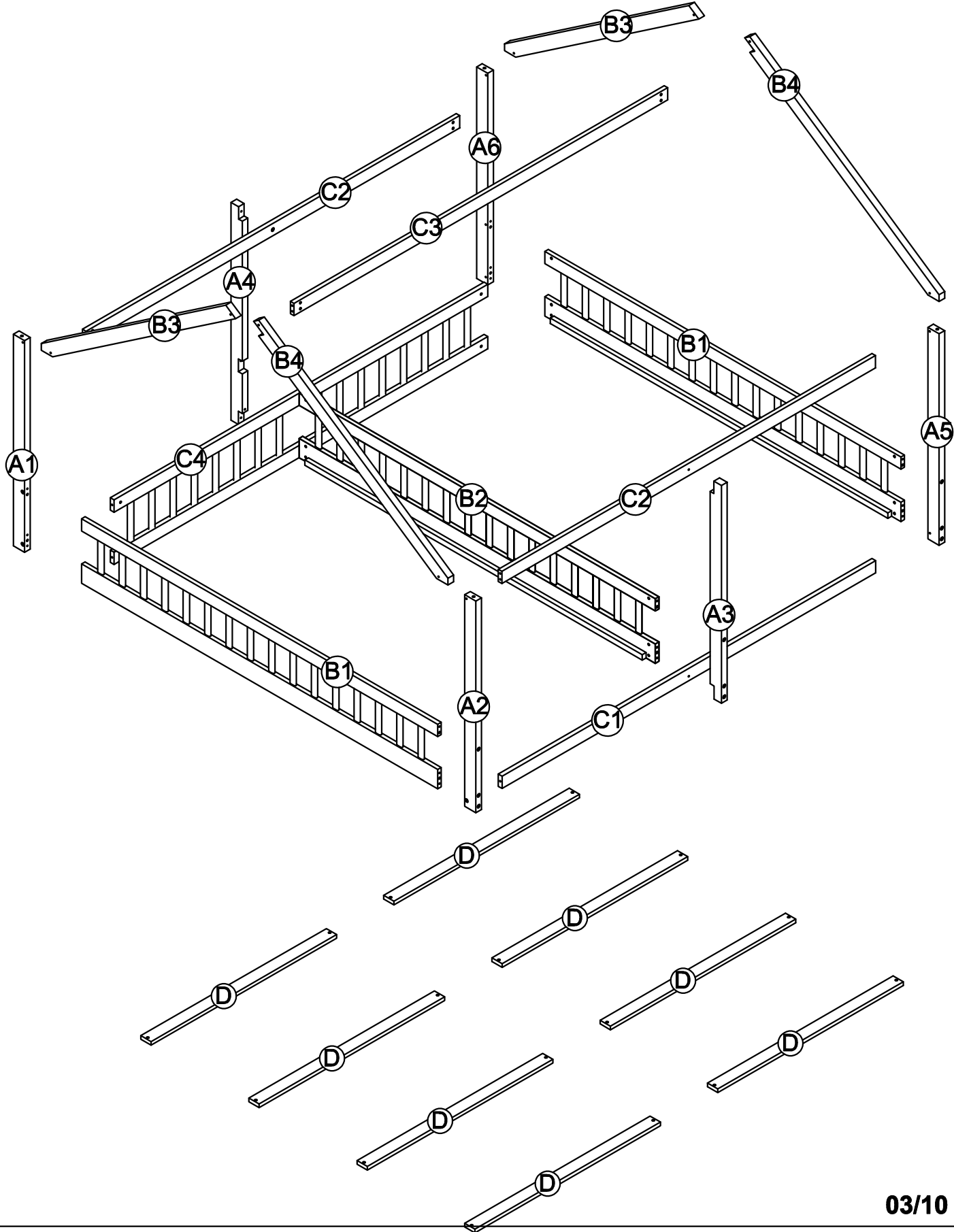

### **5.Replacement Parts:**

Replacement Parts, including additional guardrails, may be obtained from any of our (GIGACLOUD TECHNOLOGY (USA) INC.) dealers



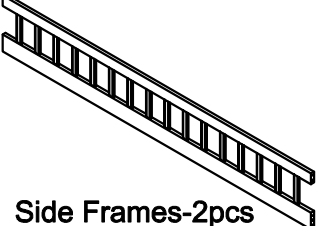
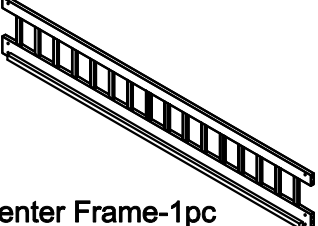

# ASSEMBLY INSTRUCTION

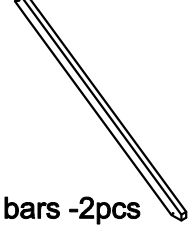
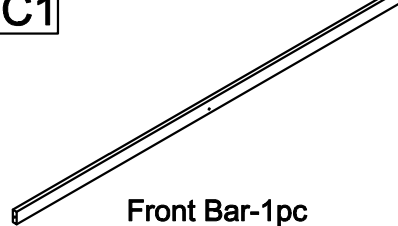
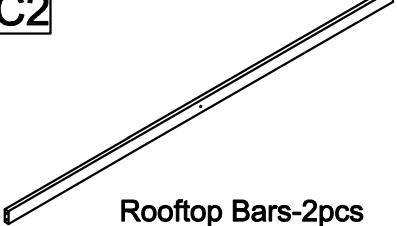
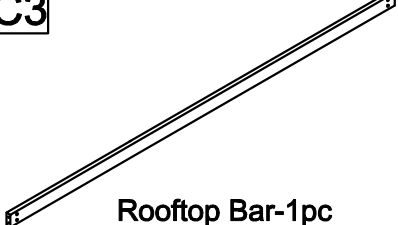
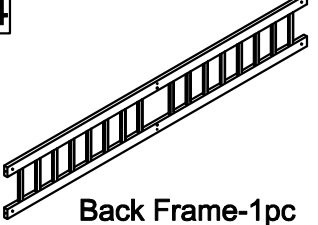
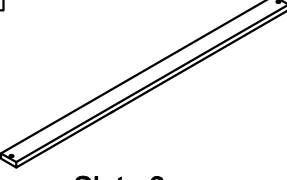

# Part List (WF296300)

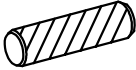
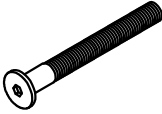
<p><b>A1</b></p>  <p>Leg(Back-Left)-1pc</p>	<p><b>A2</b></p>  <p>Leg(Front-Left)-1pc</p>	<p><b>A3</b></p>  <p>Leg(Front-Center)-1pc</p>
<p><b>A4</b></p>  <p>Leg(Back-Center)-1pc</p>	<p><b>A5</b></p>  <p>Leg(Front-Right)-1pc</p>	<p><b>A6</b></p>  <p>Leg(Back-Right)-1pc</p>
<p><b>B1</b></p>  <p>Side Frames-2pcs</p>	<p><b>B2</b></p>  <p>Center Frame-1pc</p>	<p><b>B3</b></p>  <p>Rooftop-Wood bars -2pcs</p>
<p><b>B4</b></p>  <p>Rooftop-Wood bars -2pcs</p>	<p><b>C1</b></p>  <p>Front Bar-1pc</p>	<p><b>C2</b></p>  <p>Rooftop Bars-2pcs</p>
<p><b>C3</b></p>  <p>Rooftop Bar-1pc</p>	<p><b>C4</b></p>  <p>Back Frame-1pc</p>	<p><b>D</b></p>  <p>Slats-8pcs</p>

# Hardware List

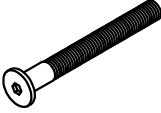

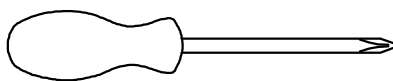
<p><b>1</b></p>  <p>Ø10 x 40 mm Wood dowel 16pcs</p>	<p><b>2</b></p>  <p>Ø1/4" x 80 mm Hex-Head bolts 18pcs</p>	<p><b>3</b></p>  <p>Ø1/4" x 13 mm Horizontal-Hole bolts 36pcs</p>
<p><b>4</b></p>  <p>Screws 1/4"x30mm 2pcs</p>	<p><b>5</b></p>  <p>M4 x 30 mm Wood Screws 16pcs</p>	<p><b>6</b></p>  <p>Allen Key 1pc</p>
<p><b>7</b></p>  <p>Ø1/4" x 100 mm Hex-Head bolts 18pcs</p>		



**Assembly Tools Required (Not Included)**

# STEP 1: Following below illustration:

- Using hardware #3,#7 and dowel #1 to Assembly A1,A2 Legs With B1 Frame
- Using hardware #3,#7 and dowel #1 to Assembly A5,A6 Legs With B1 Frame
- Look at detail view for more detail

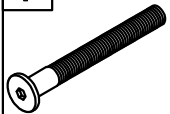
3	1
	
6x2pcs	4x2pcs
	7
	
	6x2pcs

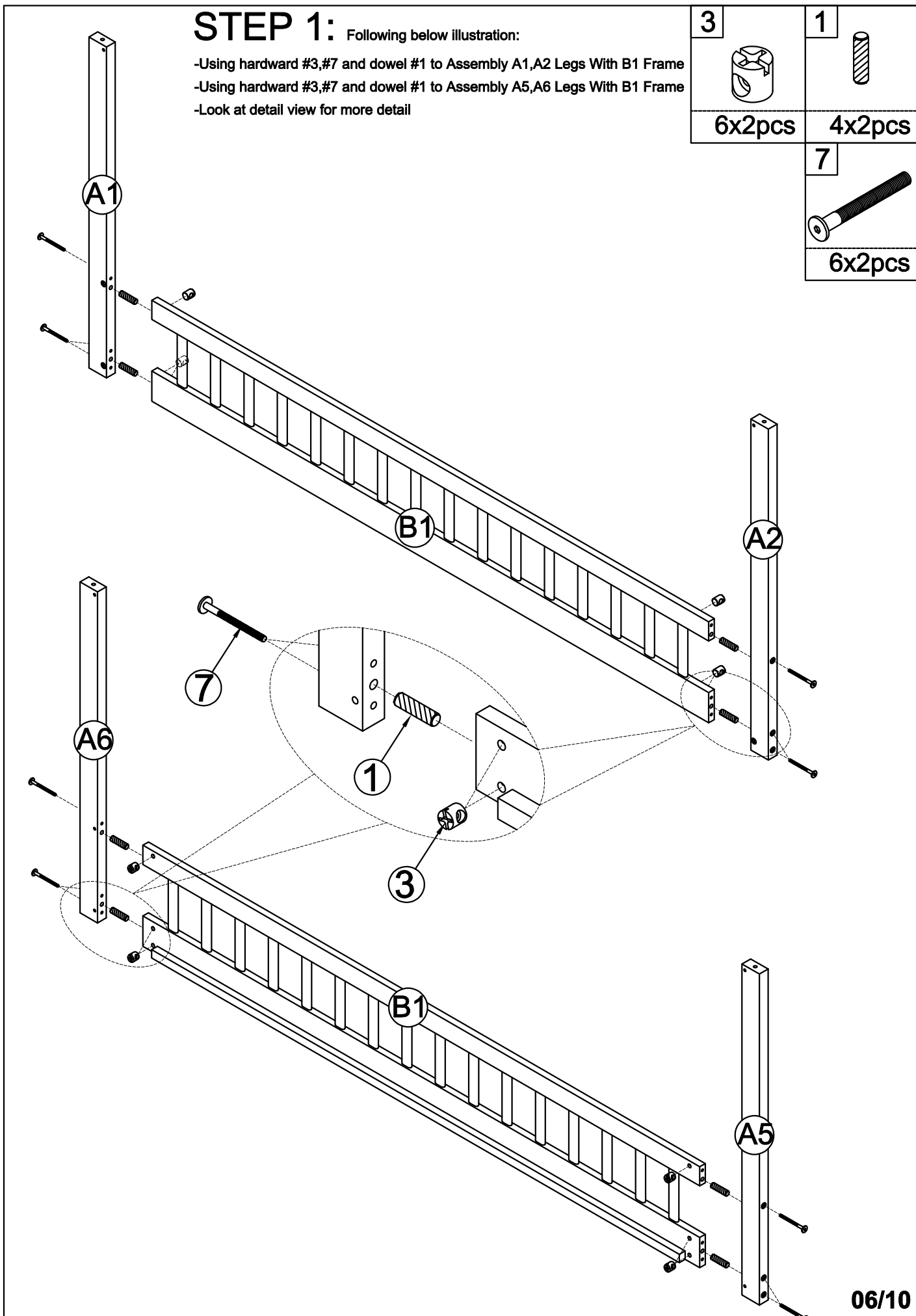

## STEP 2: Following below illustration:

- Using hardware #2,#3 to Assembly Frame (Completed on step 1)
- With C1 Bar & C4 Frame
- Look at detail view for more detail

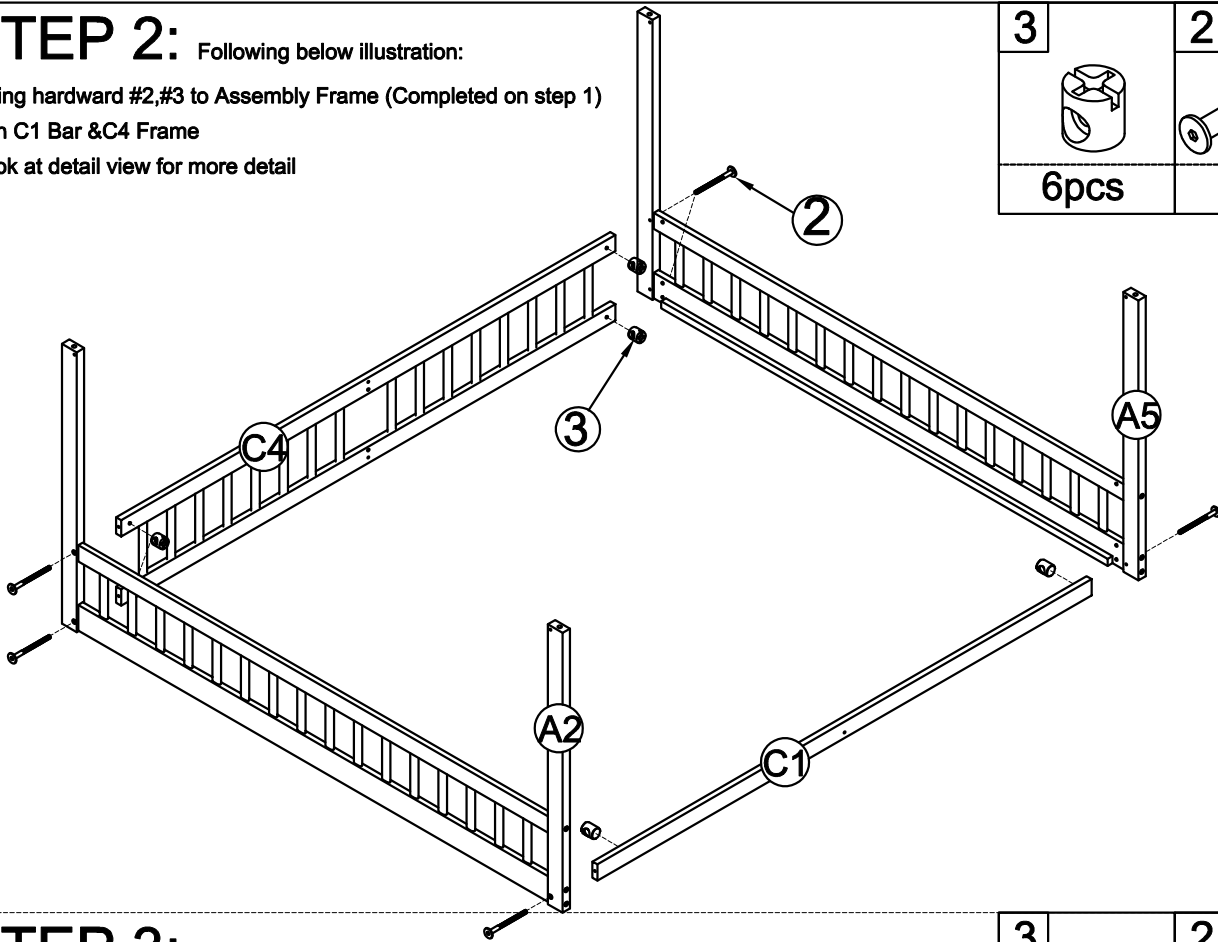

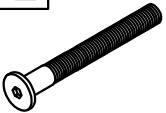
3	2
	
6pcs	6pcs

## STEP 3: Following below illustration:

- Using hardware #2,#3 to Assembly Rooftop Bars B3(x2),B4(x2) With Rooftop Bars C2(x2),C3
- Look at detail view for more detail

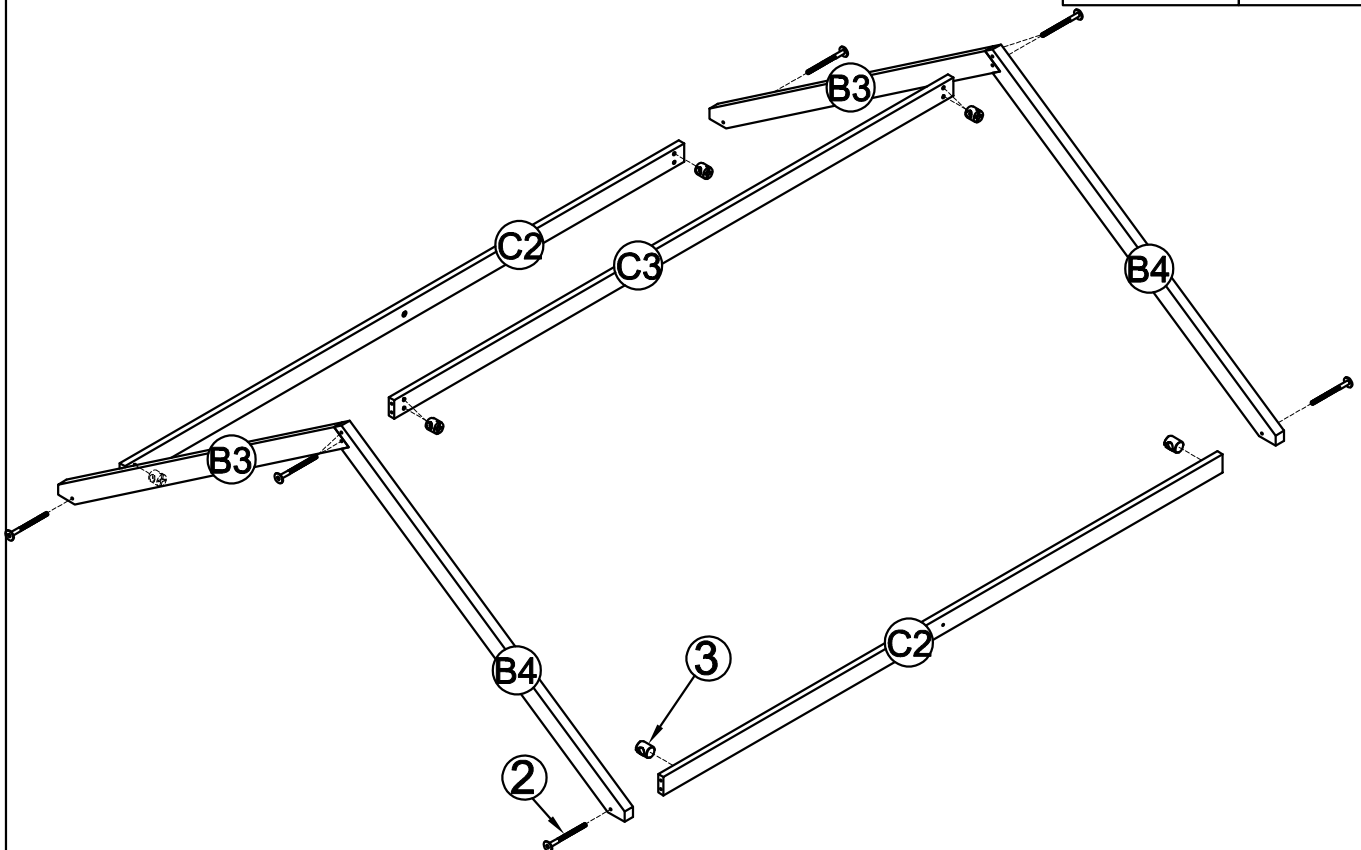

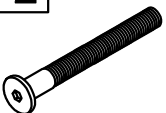

3	2
	
8pcs	8pcs

# STEP 4: Following below illustration:

-Using hardware #2,#3 and dowel 1 to Assembly Frame (Completed on step 2) With Frame (Completed on step 3)

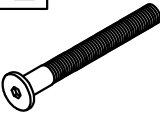
-Look at detail view for more detail

3	2
	
4pcs	4pcs
	1
	
	4pcs

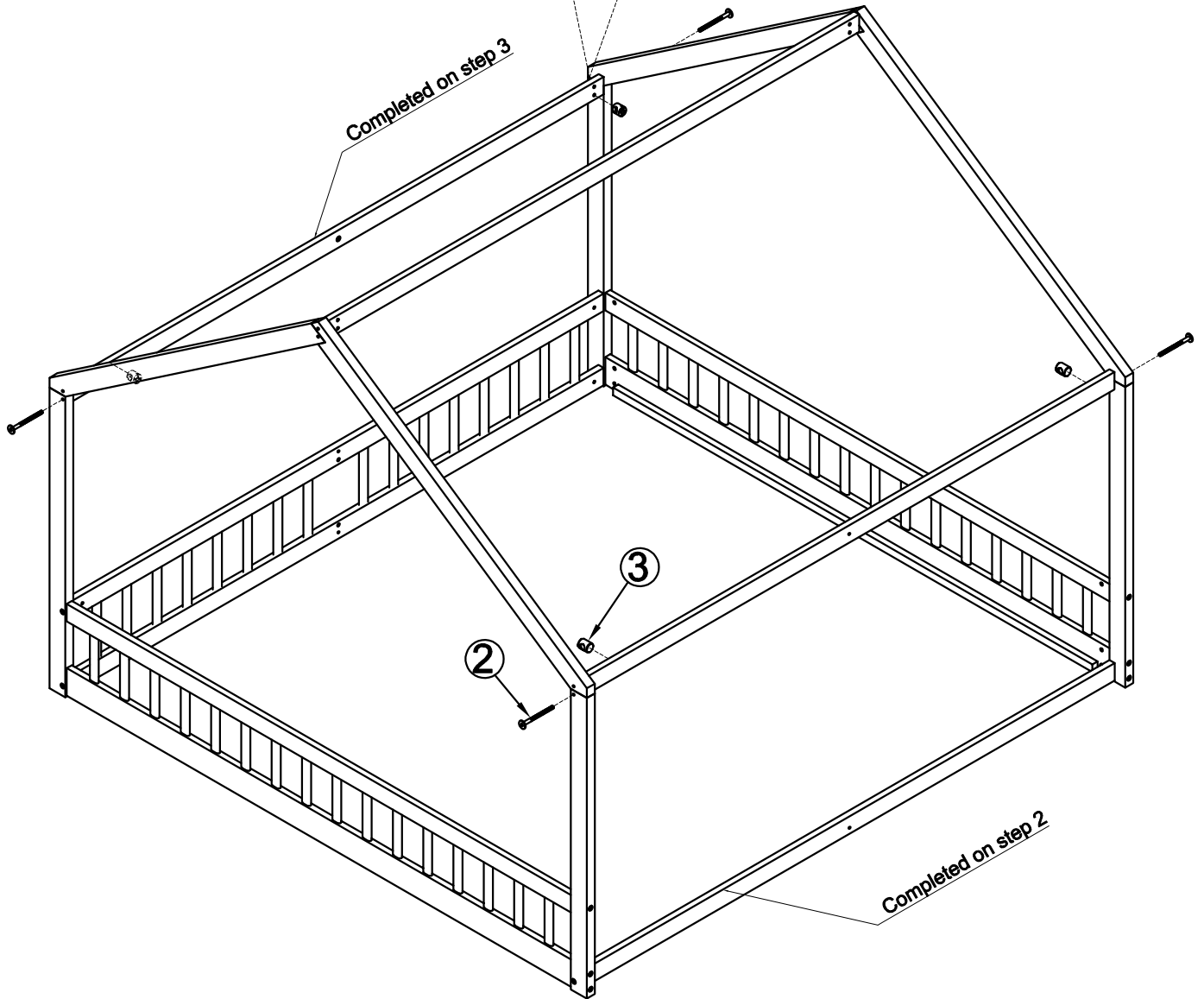
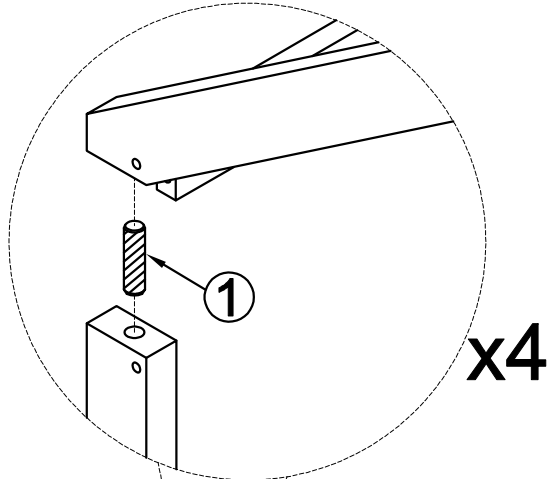





# STEP 5: Following below illustration:

-Using hardware #3,#7 and dowel #1 to Assembly Frame (Completed on step 4) With A3,A4 Legs and B2 Frame

-Look at detail view for more detail

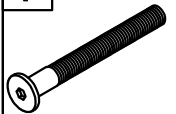
3		1	
6pcs		4pcs	
4		7	
2pcs		6pcs	

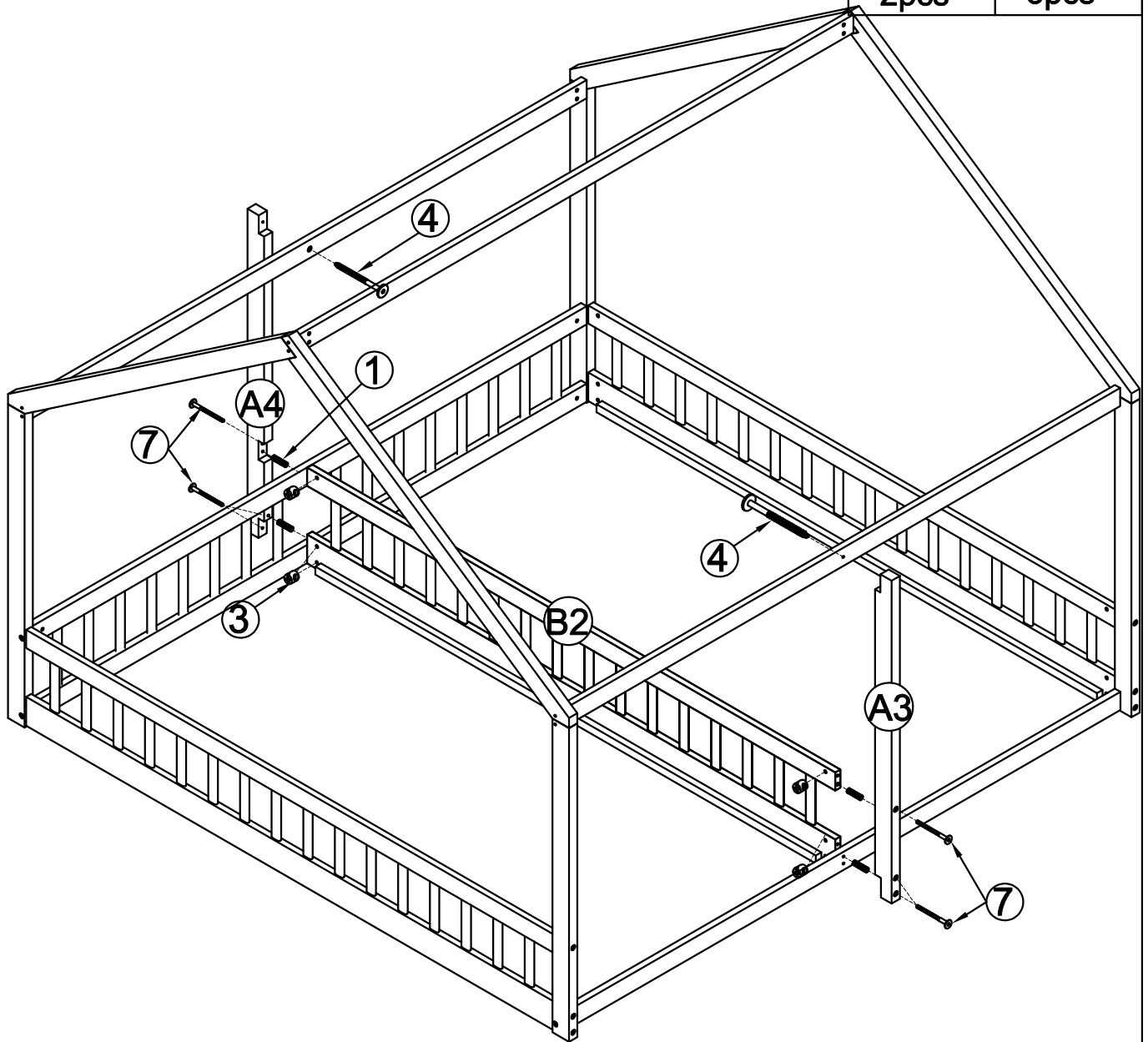

# STEP 6: Following below illustration:

-Screw slats D(x8) with Side Rail B1(x2),B2 by using hardward #5.

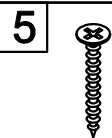

16pcs

