

FUTON BUNK BED
ASSEMBLY INSTRUCTIONS
SKU : MF286650

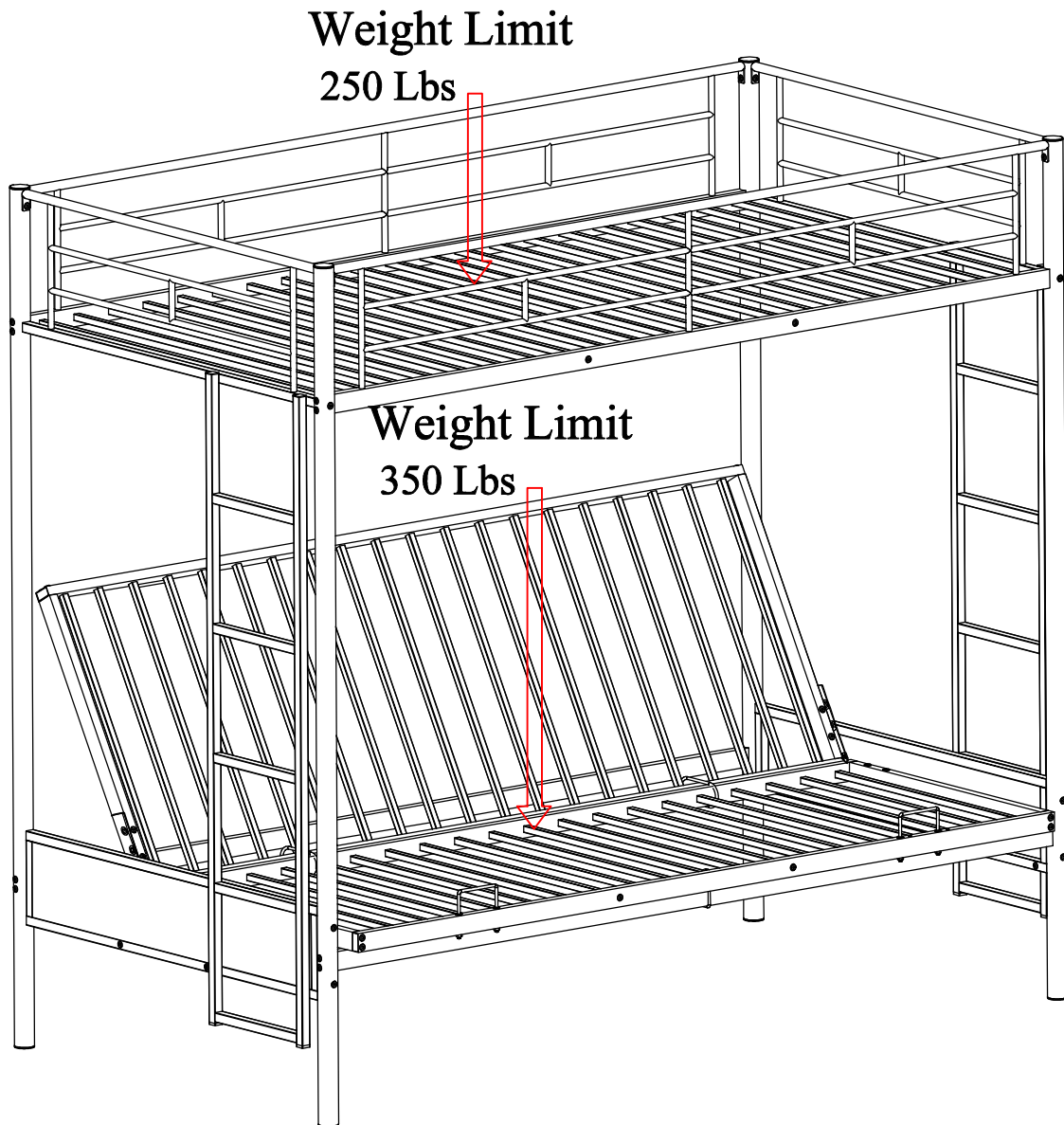

**FUTON BUNK BED
ASSEMBLY INSTRUCTIONS
SKU : MF286650**

SAFETY WARNINGS AND GENERAL NOTES:

1. Follow the information on the warnings on the bunk bed end structure and on the carton. Do not remove the warning label from the bed.
2. Always use the recommended size mattress on mattress support, or both, to help prevent the likelihood of entrapment or falls.
3. Do not allow children under 6 years of age to use the upper bunk.
4. Periodically check and ensure the guardrail, ladder and other components are in their proper position, free from damage, and all connectors are tight.
5. Do not allow horseplay on or under beds.
6. Always prohibit jumping on the bed.
7. Prohibit more than one person on upper bunk.
8. Always use the ladder for entering and leaving the upper bunk.
9. Do not use substitute parts. Contact the manufacturer or dealer for replacement parts.
10. Use of a night-light may provide added safety precaution for a child using the upper bunk.
11. Always use guardrails on both long sides of the upper bunk.
12. If the bunk bed will be placed next to a wall, the guardrail that runs the full length of the bed should be placed against the wall to prevent entrapment between the bed and the wall.

The use of water or sleep flotation mattresses is prohibited.

13. **STRANGULATION HAZARD-** Never attach or hang items to any part of the bunk bed that are not designed for use with the bed; for example, but not limited to, hook, belts and jump ropes.
14. Keep these instructions for future reference.
15. We recommend assembling your bunk bed on the shipping carton to protect your floor or carpet.
16. Be certain all staples are out of the box before beginning assembly on the shipping carton.

17. USE ONLY MATTRESSES WHICH ARE AS THE TABLE BELOW ON UPPER AND ON LOWER BUNKS.

Upper bunk (bunk bed and trilled included)

Bed type	Length	Width	Thickness
Twin	74" – 75"	38 ½"	6" max

Lower bunk

Bed type	Length	Width	Thickness
Full	74" – 75"	53"-54"	8"

18. SURFACE OF MATTRESS MUST BE AT LEAST 5" (127MM) BELOW THE UPPER EDGE OF GUARDRAILS.

19. Replacement Parts:

Replacement Parts, including additional guardrails, may be obtained from any of our (GIGACLOUD TECHNOLOGY(USA) INC.) dealers



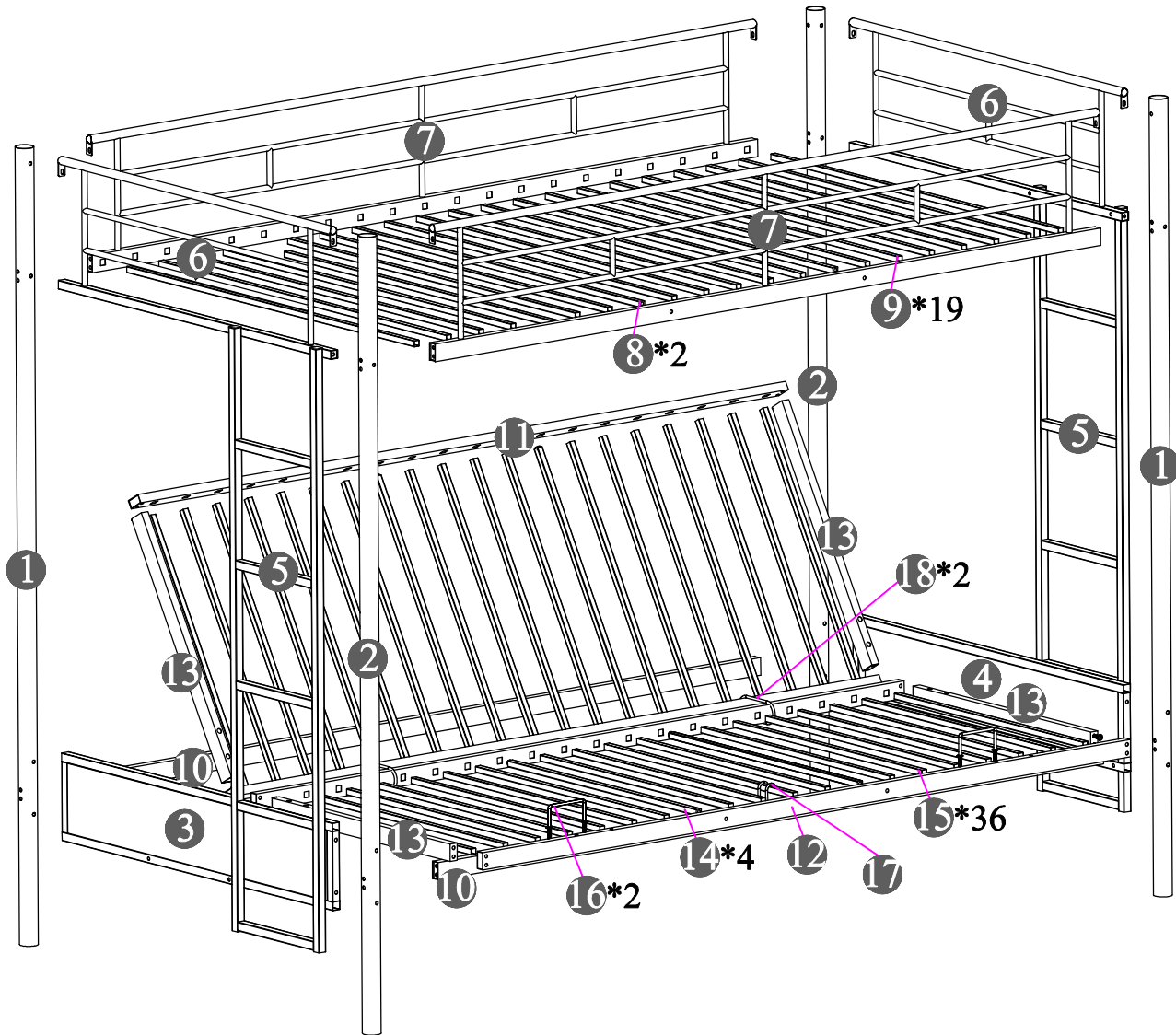

20. Please place the length of the bed side that is without handle close to the wall when using

FUTON BUNK BED
ASSEMBLY INSTRUCTIONS
SKU : MF286650



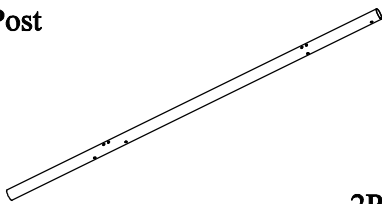
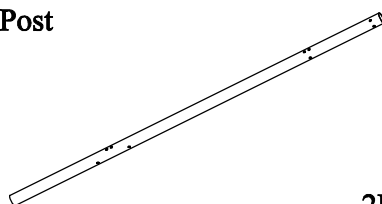
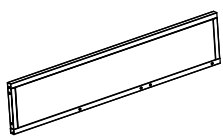
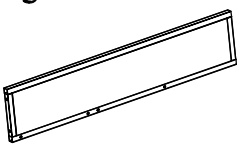
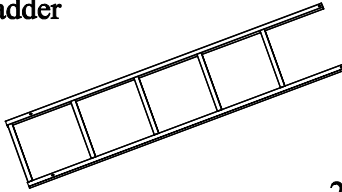
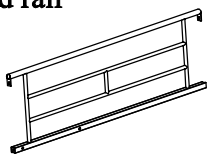
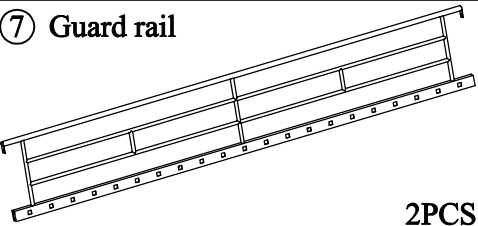
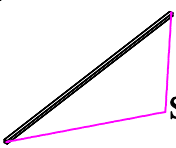
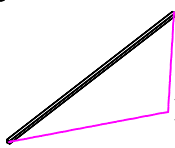
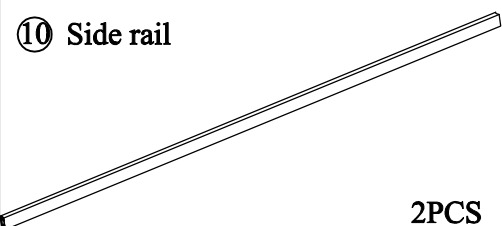
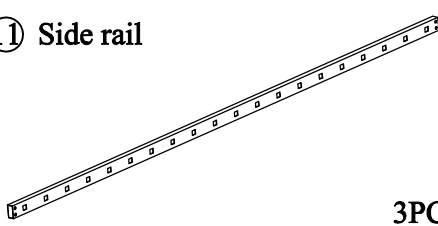
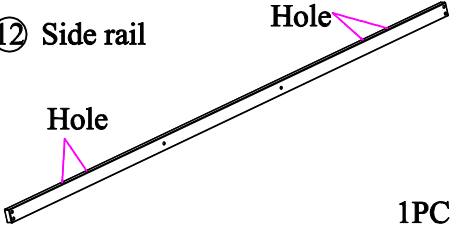
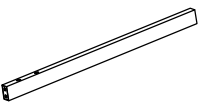
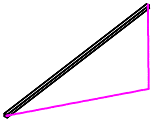
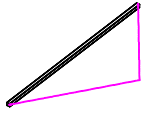





DETAIL VIEW

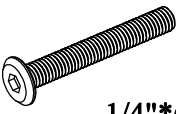
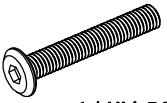
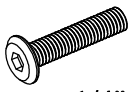
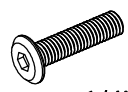

**FUTON BUNK BED
ASSEMBLY INSTRUCTIONS
SKU : MF286650
PART LIST**

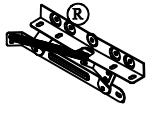
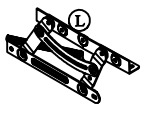
<p>① Post</p>  <p align="right">2PCS</p>	<p>② Post</p>  <p align="right">2PCS</p>	<p>③ End guard rail</p>  <p align="right">1PC</p>
<p>④ End guard rail</p>  <p align="right">1PC</p>	<p>⑤ Ladder</p>  <p align="right">2PCS</p>	<p>⑥ End guard rail</p>  <p align="right">2PCS</p>
<p>⑦ Guard rail</p>  <p align="right">2PCS</p>	<p>⑧ Slats</p>  <p align="right">2PCS</p>	<p>⑨ Slats</p>  <p align="right">19PCS</p>
<p>⑩ Side rail</p>  <p align="right">2PCS</p>	<p>⑪ Side rail</p>  <p align="right">3PCS</p>	<p>⑫ Side rail</p>  <p align="right">1PC</p>
<p>⑬ End rail</p>  <p align="right">4PCS</p>	<p>⑭ Slats</p>  <p align="right">4PCS</p>	<p>⑮ Slats</p>  <p align="right">36PCS</p>
<p>⑯ Mattress Retainer</p>  <p align="right">2PCS</p>	<p>⑰ Hook</p>  <p align="right">1PC</p>	<p>⑱ Hook</p>  <p align="right">2PCS</p>

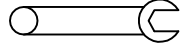
HARDWARE LIST MF 286650

<p>Ⓐ Bolts</p>  <p align="center">1/4"*60 28PCS</p>	<p>Ⓑ Bolts</p>  <p align="center">1/4"*50 8PCS</p>	<p>Ⓒ Bolts</p>  <p align="center">1/4"*35 24PCS</p>	<p>Ⓓ Bolts</p>  <p align="center">1/4"*30 4PCS</p>	<p>Ⓔ Bolts</p>  <p align="center">1/4"*15 20PCS</p>	<p>Ⓕ End cap</p>  <p align="center">Ø42 8PCS</p>	
<p>Ⓖ End cap</p>  <p align="center">20*20 4PCS</p>	<p>Ⓖ Nut hex</p>  <p align="center">1/4"*5 16PCS</p>	<p>Ⓖ Right mechanism</p>  <p align="center">1PC</p>	<p>Ⓖ Left mechanism</p>  <p align="center">1PC</p>	<p>Ⓖ End cap</p>  <p align="center">1/4"*40 2 SET</p>	<p>Ⓖ Wrench</p>  <p align="center">1PC</p>	<p>Ⓖ Allen key</p>  <p align="center">4*59 1PC</p>

Assembly tools such as drilling machine and screwdriver, please prepare by yourself, thank you!

FUTON BUNK BED
 ASSEMBLY INSTRUCTIONS
 SKU : MF286650

STEP 1

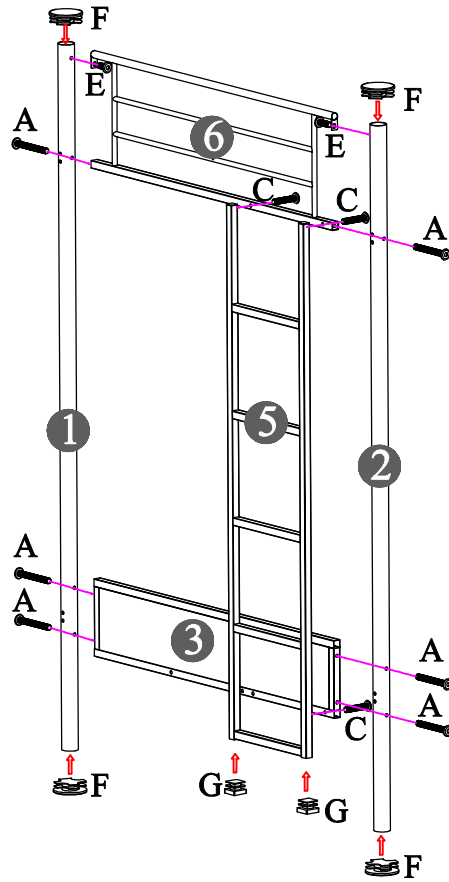

(A)	6PCS
	1/4*60
(C)	4PCS
	1/4*35
(E)	2PCS
	1/4*15
(F)	4PCS
	Ø42
(G)	2PCS
	20*20
(N)	1PC
	4*59

STEP 2

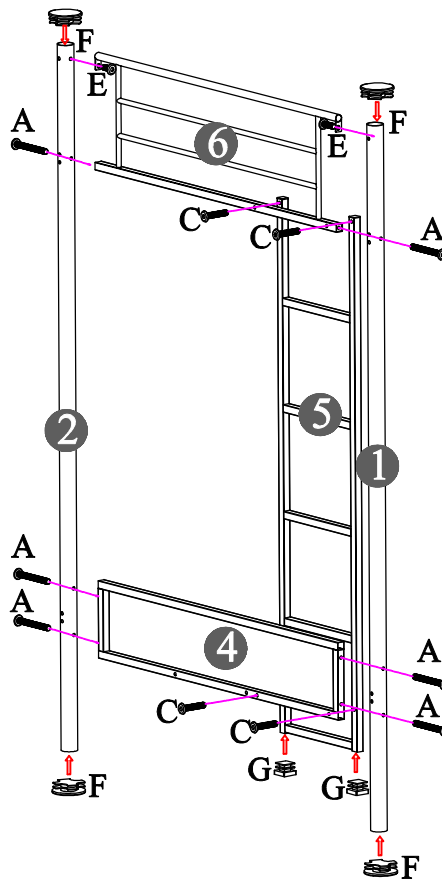



(A)	6PCS
	1/4*60
(C)	4PCS
	1/4*35
(E)	2PCS
	1/4*15
(F)	4PCS
	Ø42
(G)	2PCS
	20*20
(N)	1PC
	4*59

FUTON BUNK BED
 ASSEMBLY INSTRUCTIONS
 SKU : MF286650

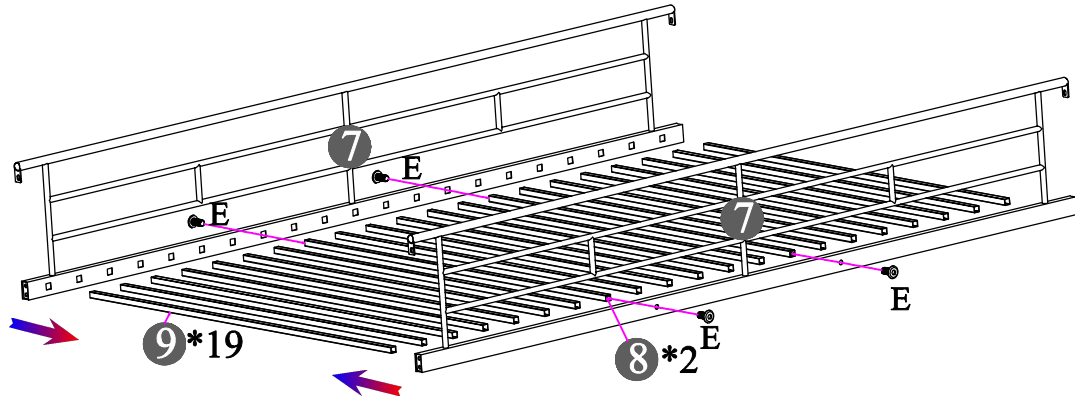

STEP 3

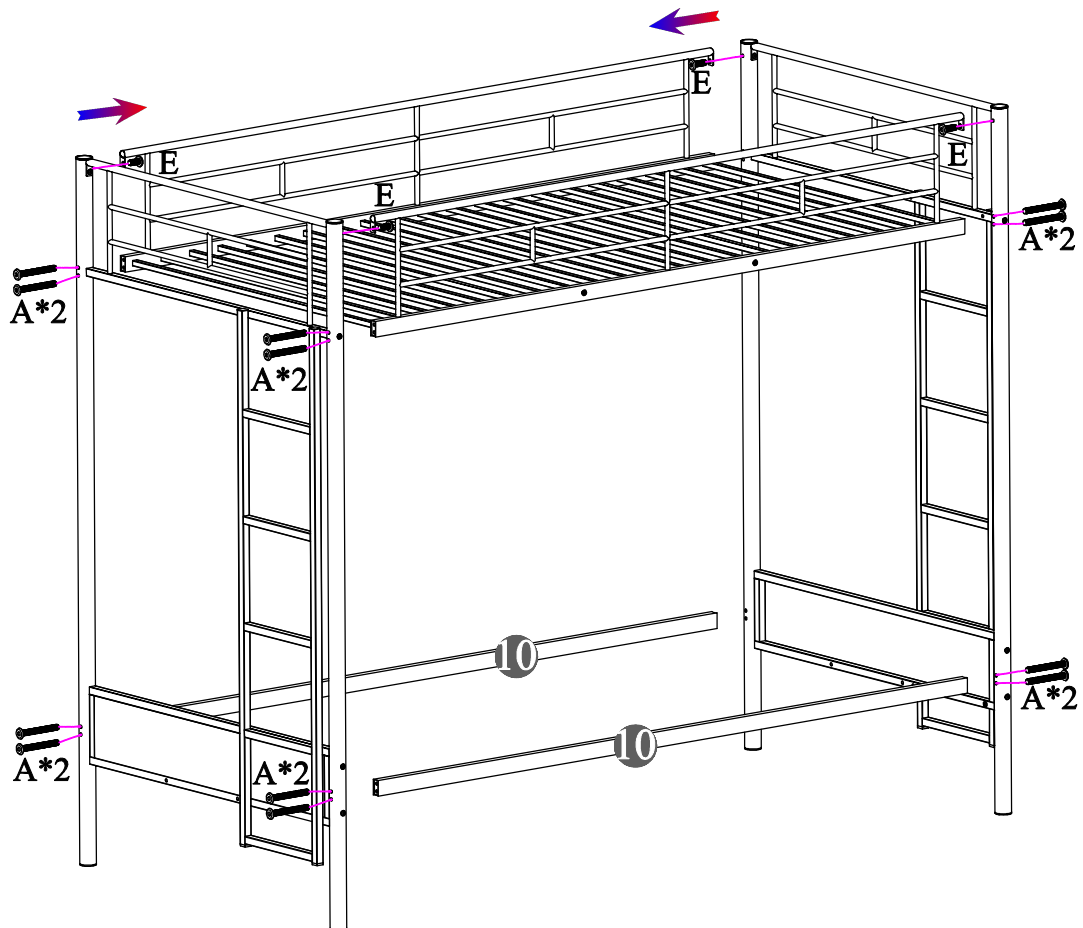

(E)	4PCS
	1/4*15
(N)	1PC
	4*59

STEP 4



(A)	16PCS
	1/4*60
(E)	4PCS
	1/4*15
(N)	1PC
	4*59

FUTON BUNK BED
 ASSEMBLY INSTRUCTIONS
 SKU : MF286650

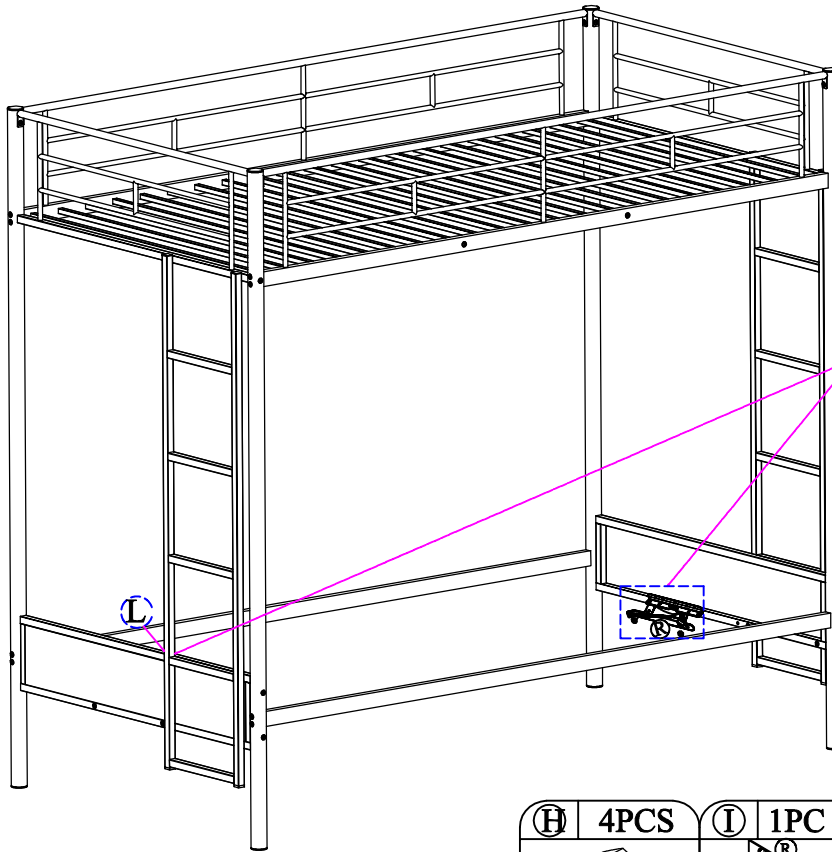

STEP 5

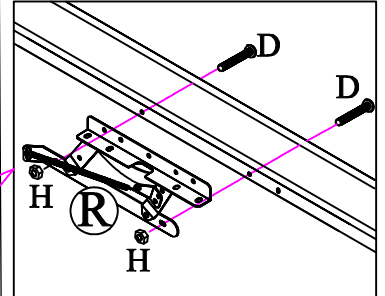

Note: For you safety, please ensure (R&L) are mounted on corresponding, location as specified in drawing

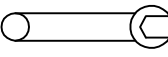

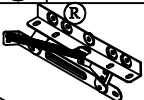
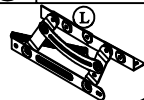
D	4PCS
	1/4*30
M	1PC
	

H	4PCS	I	1PC	K	1PC	N	1PC
	1/4*5						

STEP 6

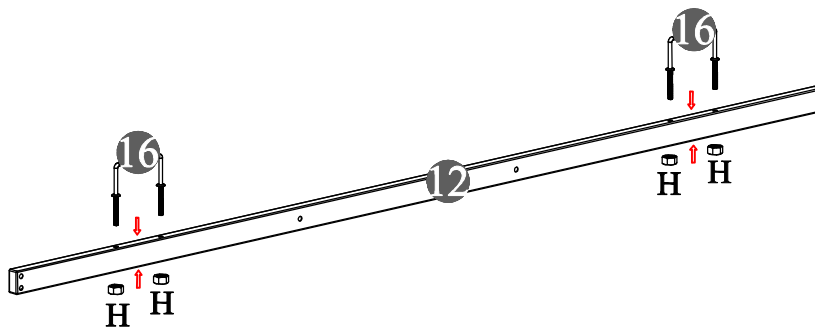

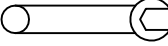

H	4PCS
	1/4*5
M	1PC
	

FUTON BUNK BED
 ASSEMBLY INSTRUCTIONS
 SKU : MF286650

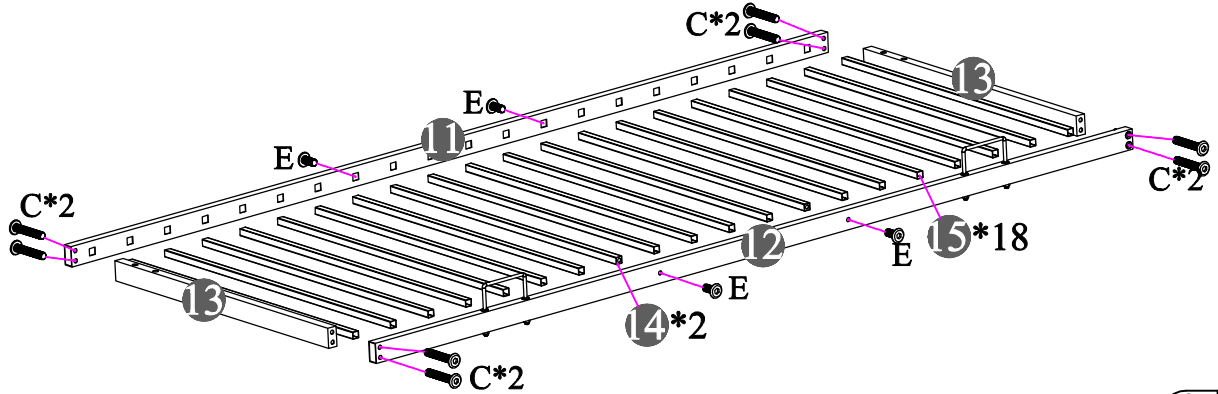

STEP 7

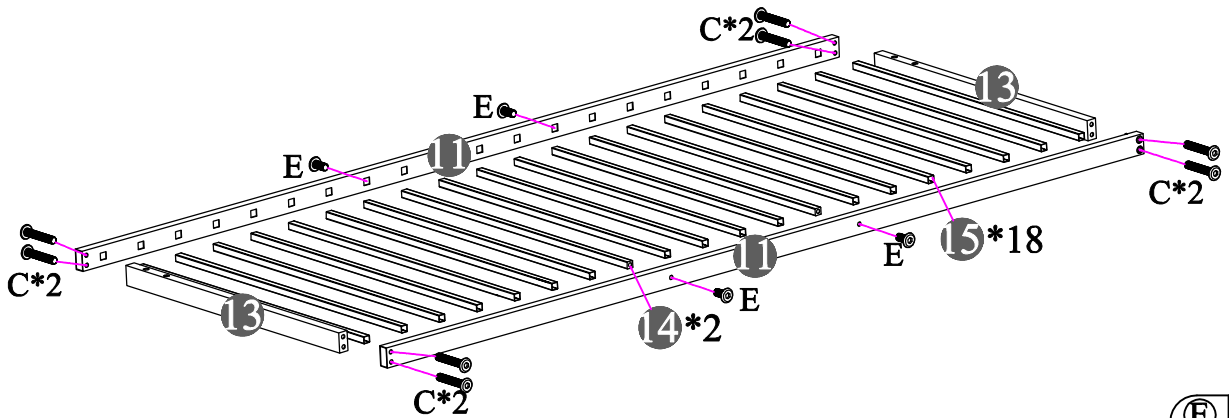

(E)	4PCS
	1/4*15
(C)	8PCS
	1/4*35
(N)	1PC
	4*59

STEP 8





(E)	4PCS
	1/4*15
(C)	8PCS
	1/4*35
(N)	1PC
	4*59

FUTON BUNK BED
 ASSEMBLY INSTRUCTIONS
 SKU : MF286650

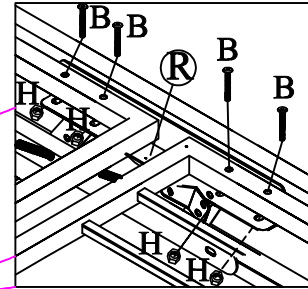
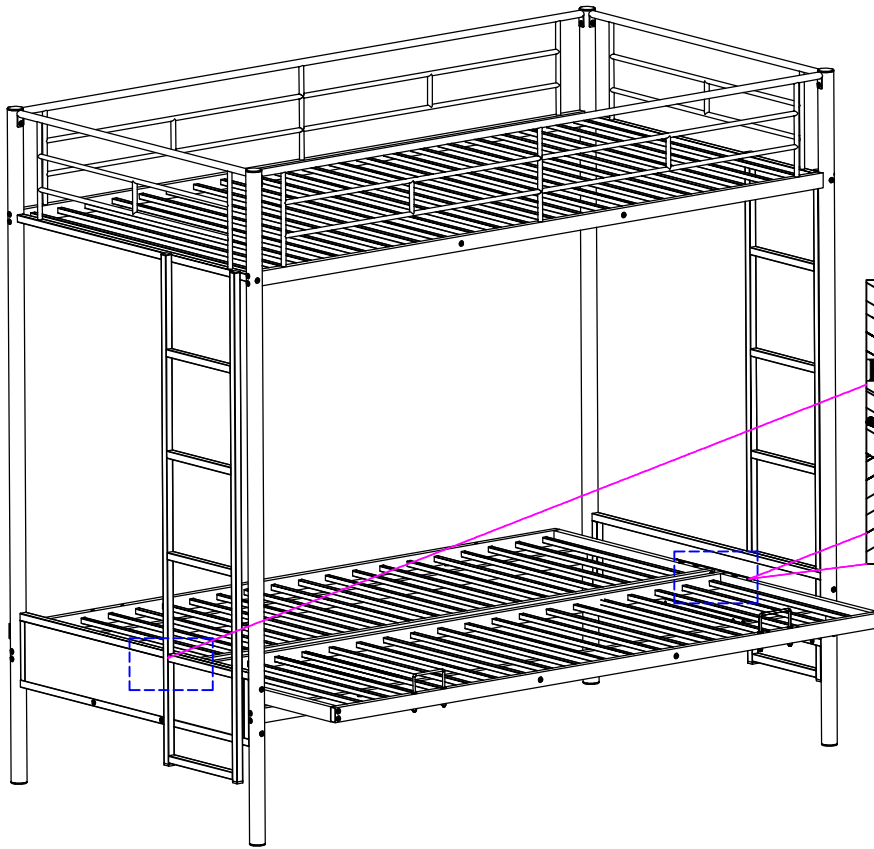
STEP 9

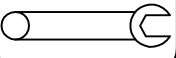

- | | |
|---|--------|
| (B) | 8PCS |
|  | 1/4*50 |
| (M) | 1PC |
|  | |
| (H) | 8PCS |
|  | 1/4*5 |
| (N) | 1PC |
|  | 4*59 |

STEP 10

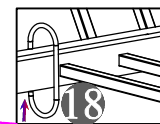
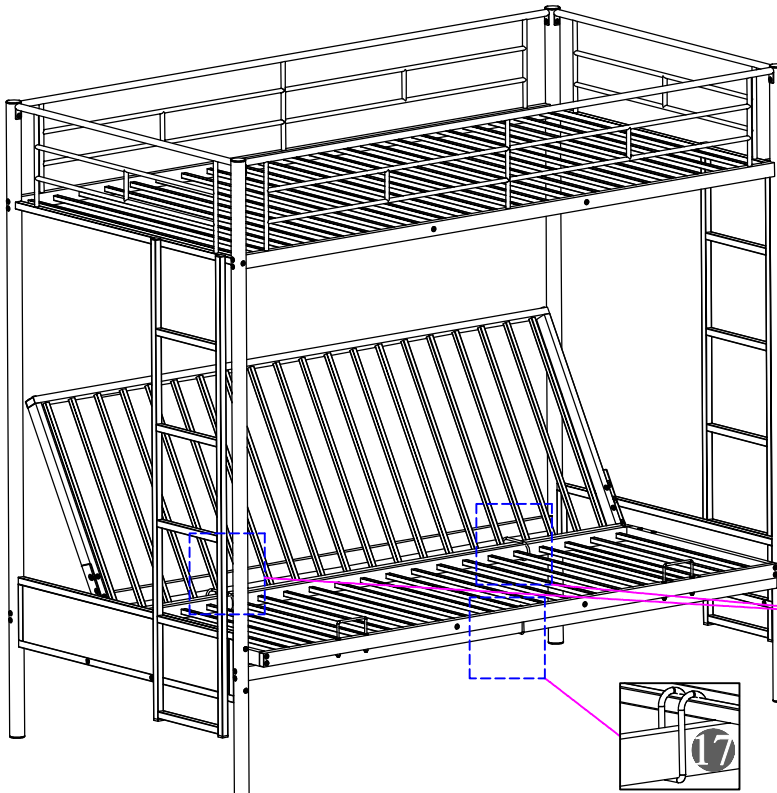

Install the hook back into the new position

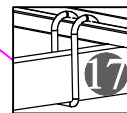

Install the hook back into the new position

FUTON BUNK BED
ASSEMBLY INSTRUCTIONS
SKU : MF286650

STEP 11

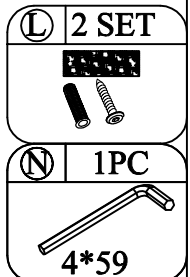
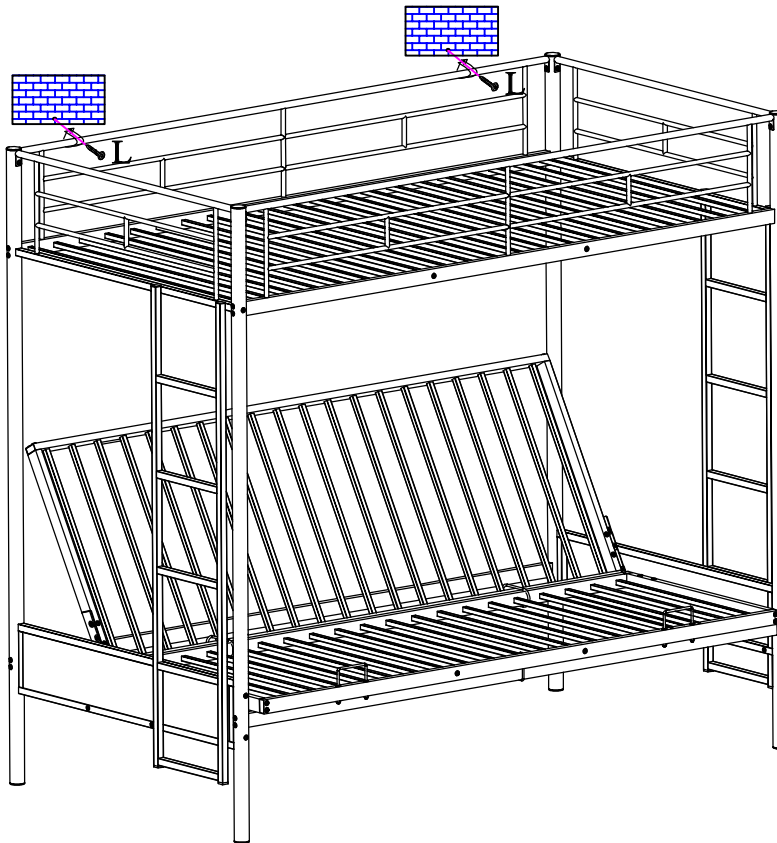

STEP 12

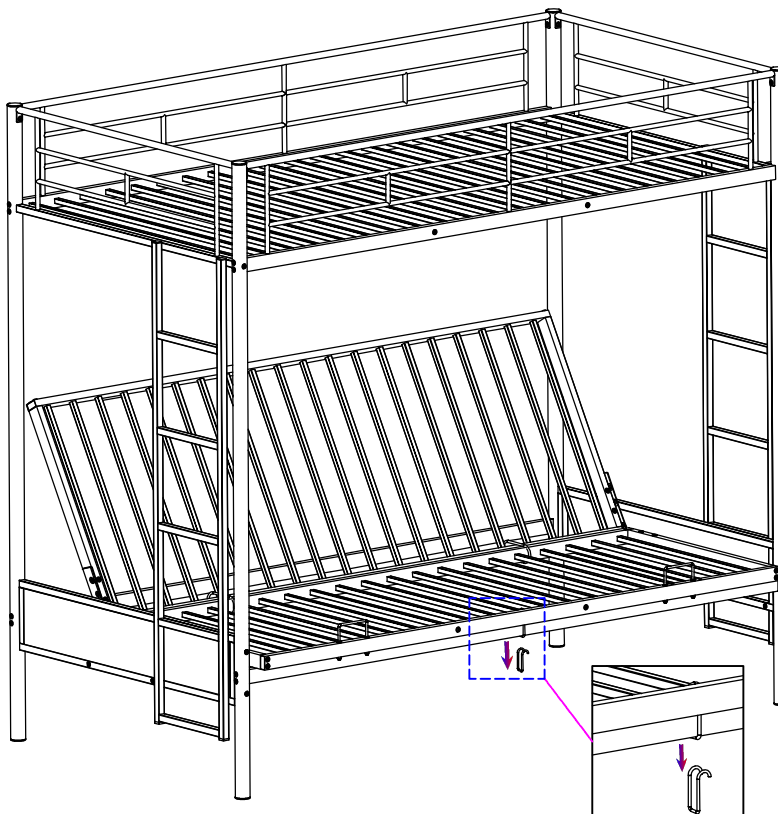

- Please follow below step to fold and unfold for lower bunk :
1. Remove the hook from it's original position
 2. Impact on the back half of the bed to fold up and down to create a sofa or bed style
 3. Install the hook back into the new position

Remove the hook from it's original position

This is the sofa style, the mattress is intended for using in sofa is 74" - 75" length , 24" - 25" width and 8" thickness

FUTON BUNK BED
ASSEMBLY INSTRUCTIONS
SKU : MF286650

STEP 13

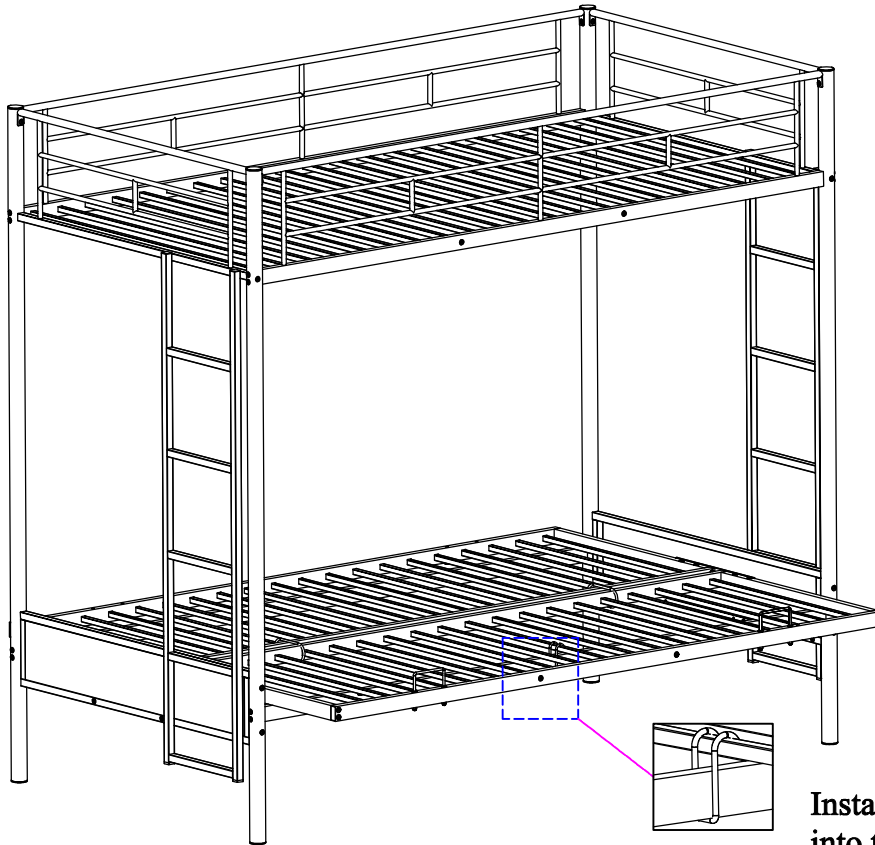

Install the hook back
into the new position

