

ASSEMBLY INSTRUCTIONS

LOFT BED



WF288853

SAFETY WARNINGS AND GENERAL NOTES

1. Follow the information on the warnings on the bunk bed end structure and on the carton. Do not remove the warning label from the bed.
2. Always use the recommended size mattress on mattress support, or both, to help prevent the likelihood of entrapment or falls.
3. Do not allow children under 6 years of age to use the upper bunk.
4. Periodically check and ensure the guardrail, ladder and other components are in their proper position, free from damage, and all connectors are tight.
5. Do not allow horseplay on or under beds.
6. Always prohibit jumping on the bed.
7. Prohibit more than one person on upper bunk.
8. Always use the ladder for entering and leaving the upper bunk.
9. Do not use substitute parts. Contact the manufacturer or dealer for replacement parts.
10. Use of a night-tight may provide added safety precaution for a child using the upper bunk.
11. Always use guardrails on both long sides of the upper bunk.
12. If the bunk bed will be placed next to a wall, the guardrail that runs the full length of the bed should be placed against the wall to prevent entrapment between the bed and the wall. The use of water or sleep flotation mattresses is prohibited.
13. STRANGULATION HAZARD-Never attach or hang items to any part of the bunk bed that are not designed for use with the bed.
14. Keep these instructions for future reference.
15. We recommend assembling your bunk bed on the shipping carton to protect your floor or carpet.
16. Be certain all staples are out of the box before beginning assembly on the shipping carton.
17. USE ONLY MATTRESSES WHICH ARE AS THE TABLE BELOW ON UPPER BUNK.

Up bed(bunk bed and tribed included)

Bed type	Length	Width	Thickness
Twin Standard	74" – 75"	38 ½"	6"



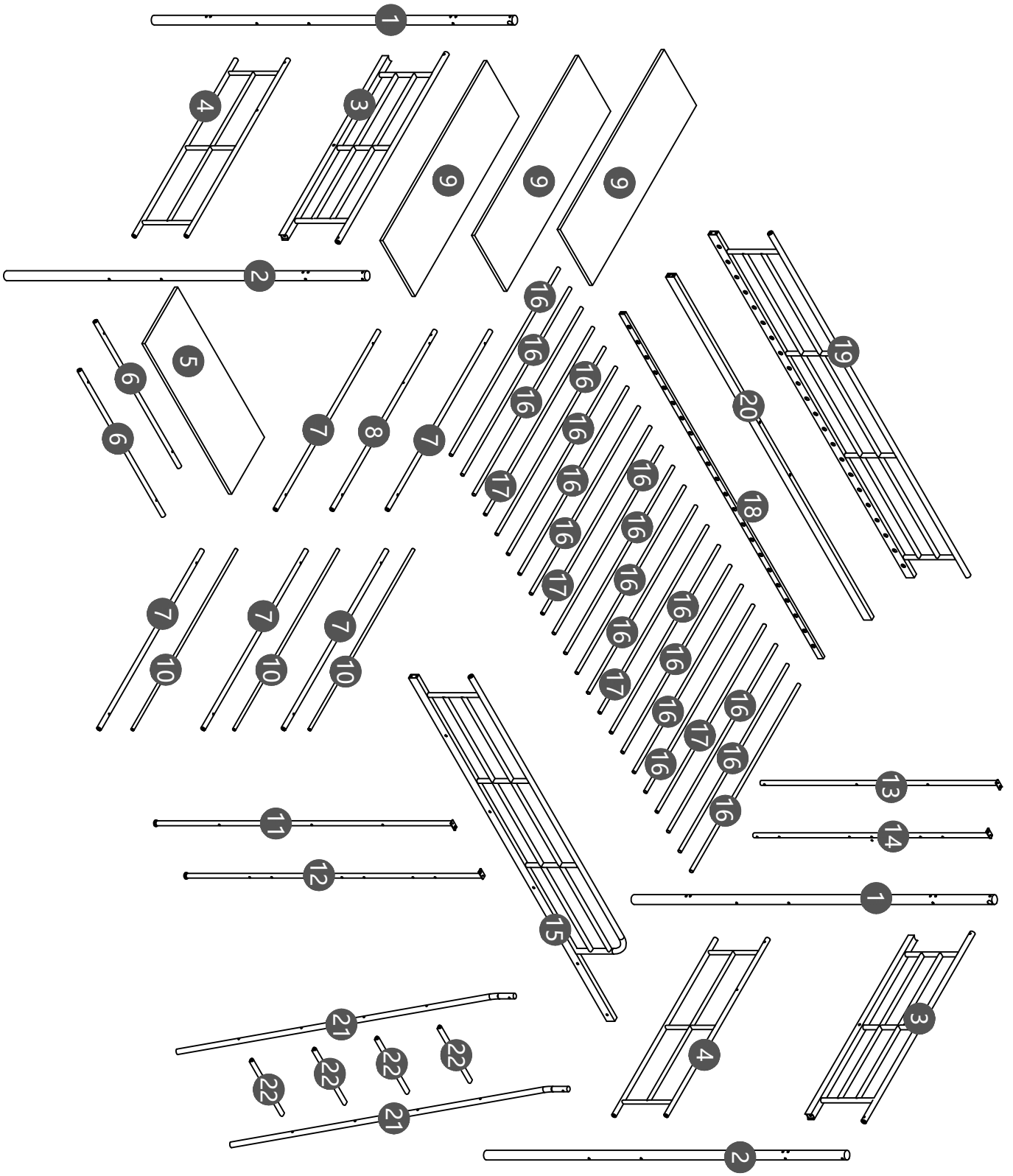

18. SURFACE OF MATTRESS MUST BE AT LEAST 5" (127MM) BELOW THE UPPER EDGE OF GUARDRAILS.

19. Replacement Parts:



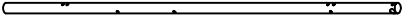
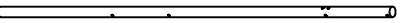
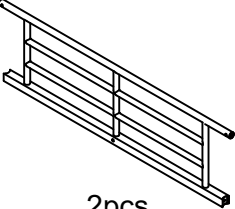
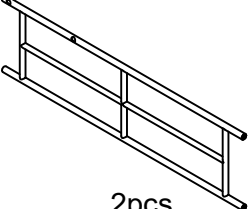
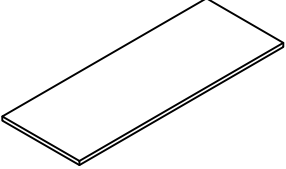
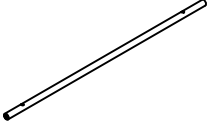
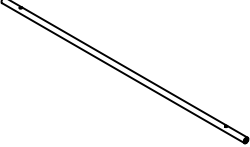
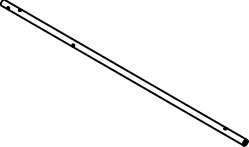
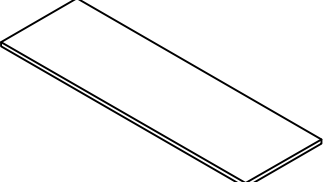
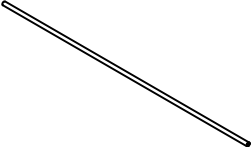

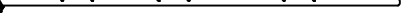
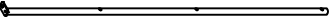
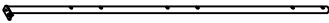
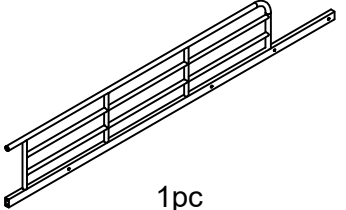
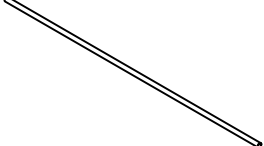
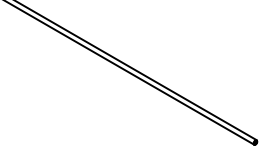
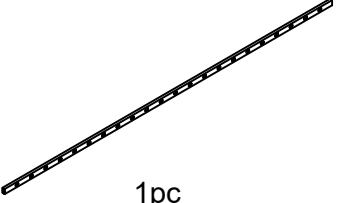
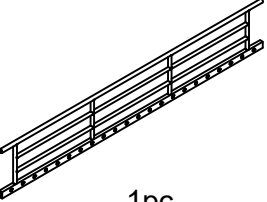
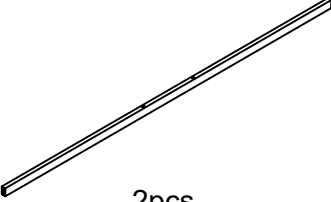
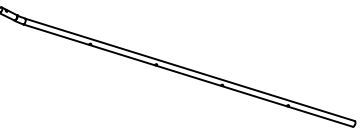



Replacement Parts, including additional guardrails, may be obtained from any of our (GIGACLOUD TECHNOLOGY (USA) INC) dealers.



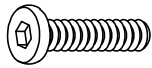
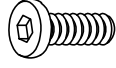

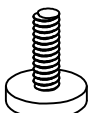
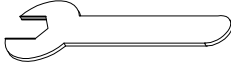
Parts List

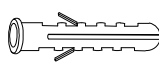
<p>1</p>  <p>2pcs</p>	<p>2</p>  <p>2pcs</p>	<p>3</p>  <p>2pcs</p>
<p>4</p>  <p>2pcs</p>	<p>5</p>  <p>1pc</p>	<p>6</p>  <p>2pcs</p>
<p>7</p>  <p>5pcs</p>	<p>8</p>  <p>1pc</p>	<p>9</p>  <p>3pcs</p>
<p>10</p>  <p>3pcs</p>	<p>11</p>  <p>1pc</p>	<p>12</p>  <p>1pc</p>
<p>13</p>  <p>1pc</p>	<p>14</p>  <p>1pc</p>	<p>15</p>  <p>1pc</p>
<p>16</p>  <p>18pcs</p>	<p>17</p>  <p>4pcs</p>	<p>18</p>  <p>1pc</p>
<p>19</p>  <p>1pc</p>	<p>20</p>  <p>2pcs</p>	<p>21</p>  <p>2pcs</p>
<p>22</p>  <p>4pcs</p>		

Hardware List

<p>A</p>  <p>M6*55mm 30pcs</p>	<p>B</p>  <p>M6*40mm 11pcs</p>	<p>C</p>  <p>M6*30mm 22pcs</p>
<p>D</p>  <p>M6*28mm 16pcs</p>	<p>E</p>  <p>M6*16mm 15pcs</p>	<p>F</p>  <p>M6 1pc</p>
<p>G</p>  <p>16pcs</p>	<p>H</p>  <p>2pcs</p>	<p>I</p>  <p>1pc</p>
<p>J</p>  <p>1pc</p>	<p>K</p>  <p>2pcs</p>	<p>L</p>  <p>2pcs</p>
<p>M</p>  <p>2pcs</p>		

STEP 1:

A	E
	
12PCS	4PCS

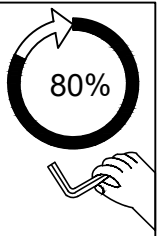
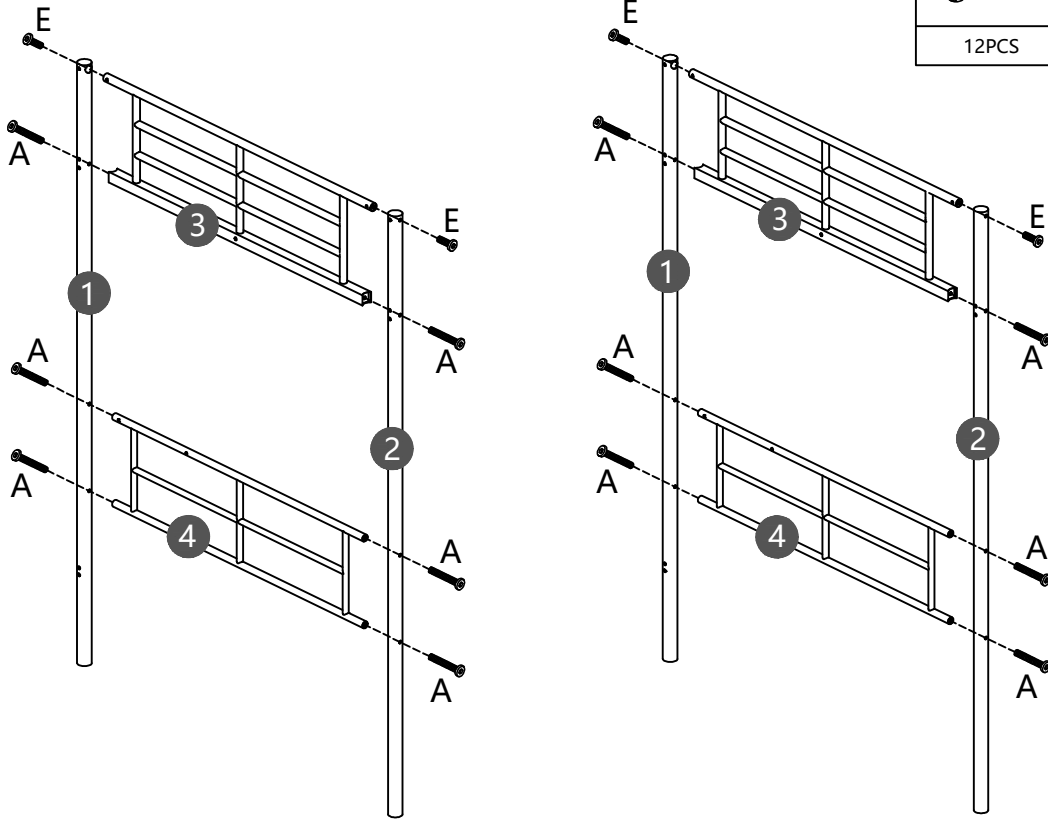

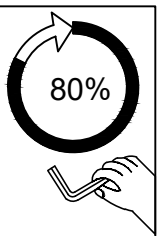
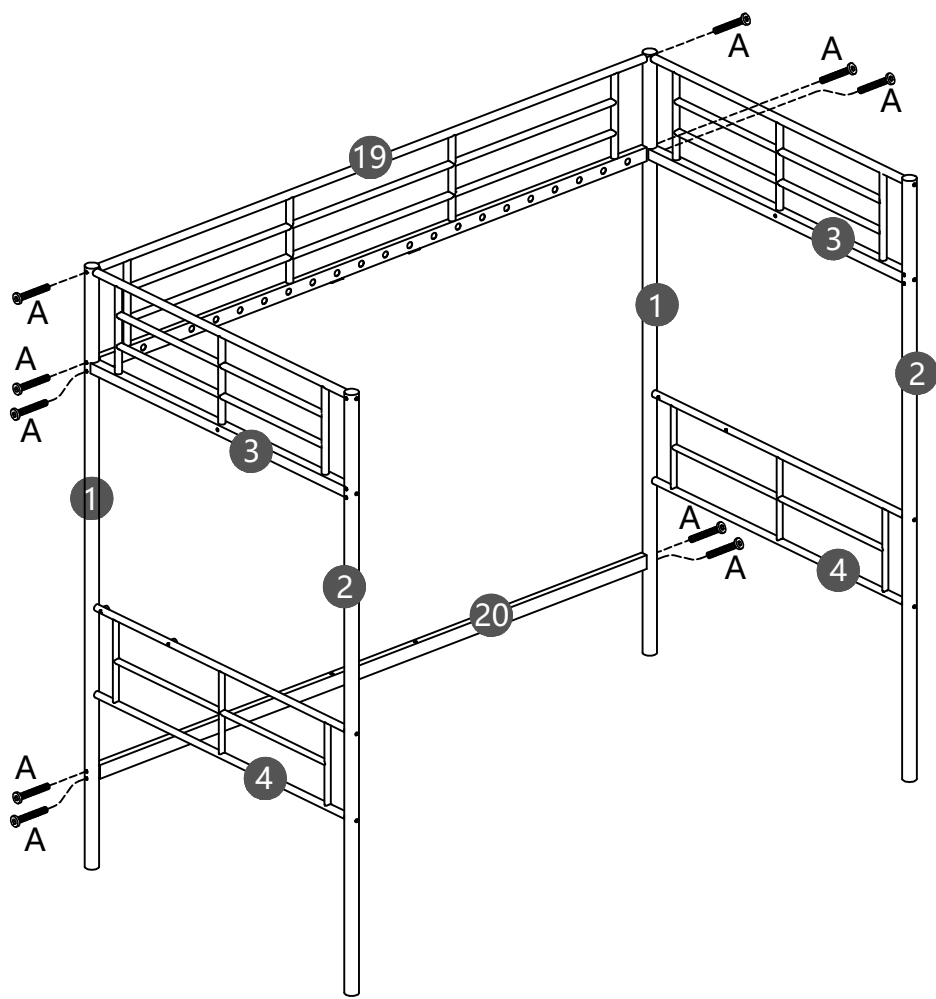

STEP 2:

A

10PCS

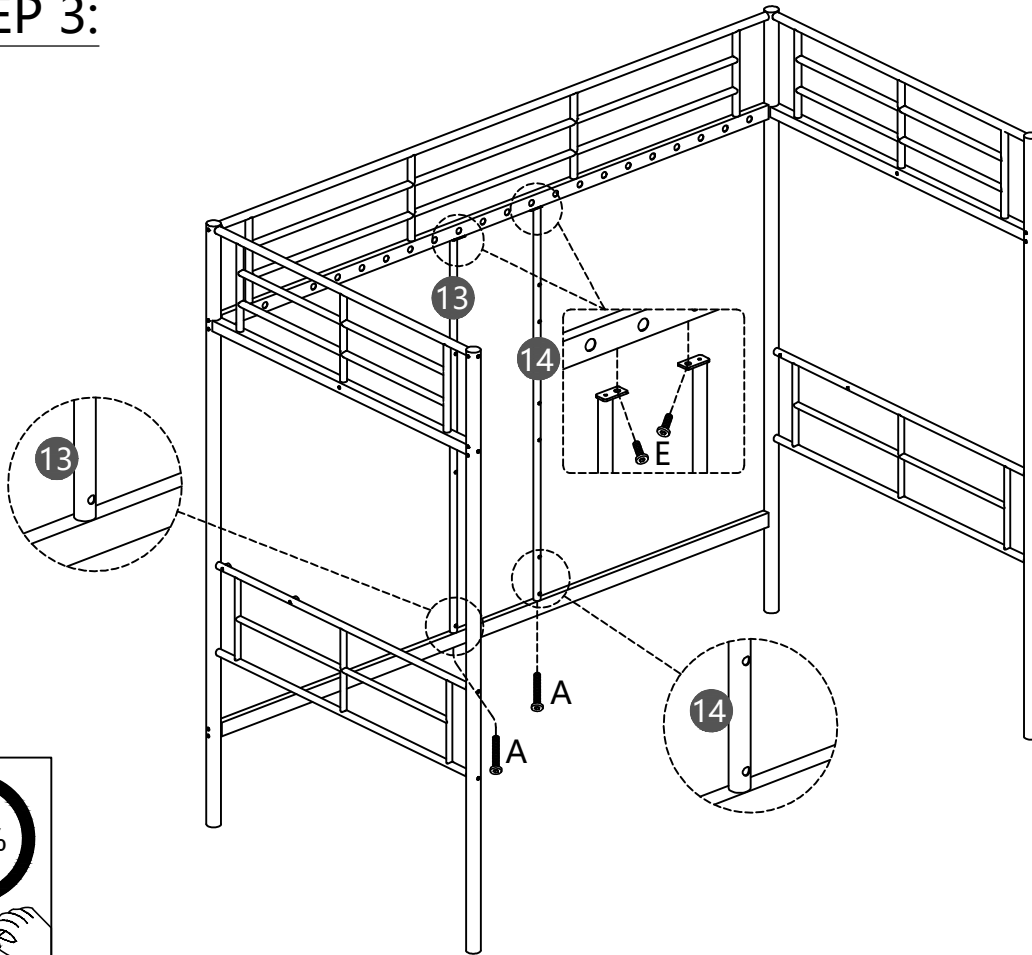

STEP 3:

A	E
	
2PCS	2PCS



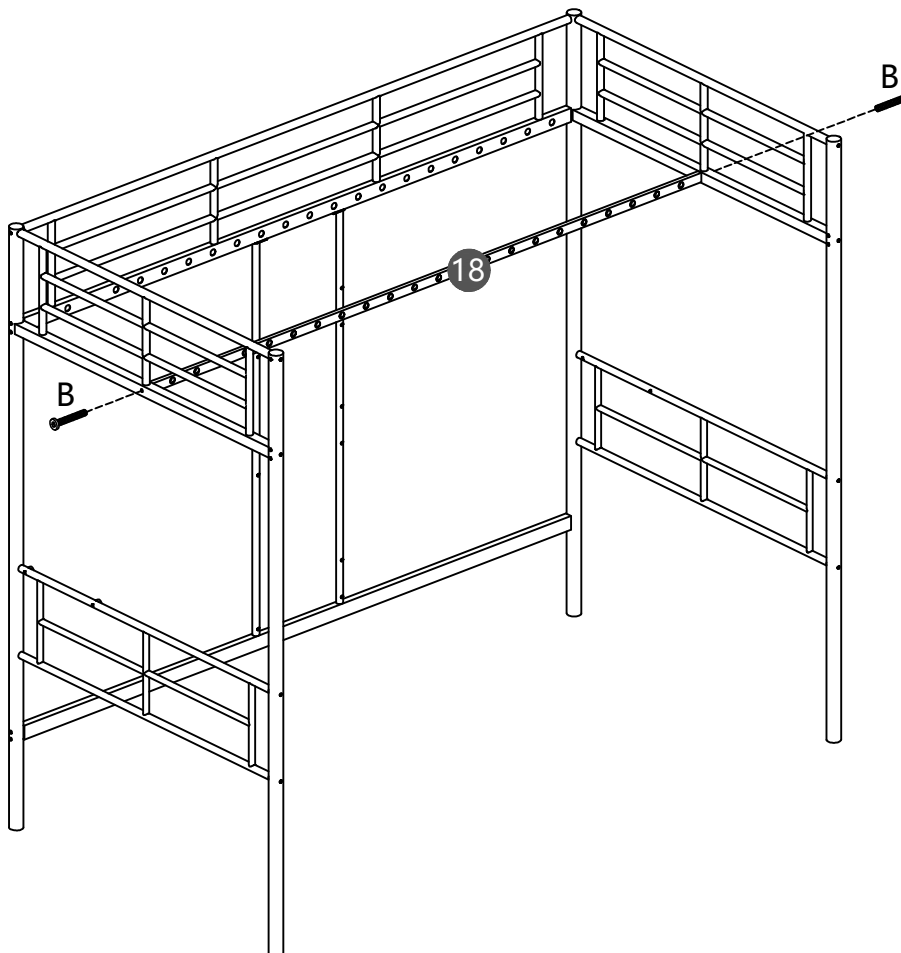

STEP 4:

B

2PCS

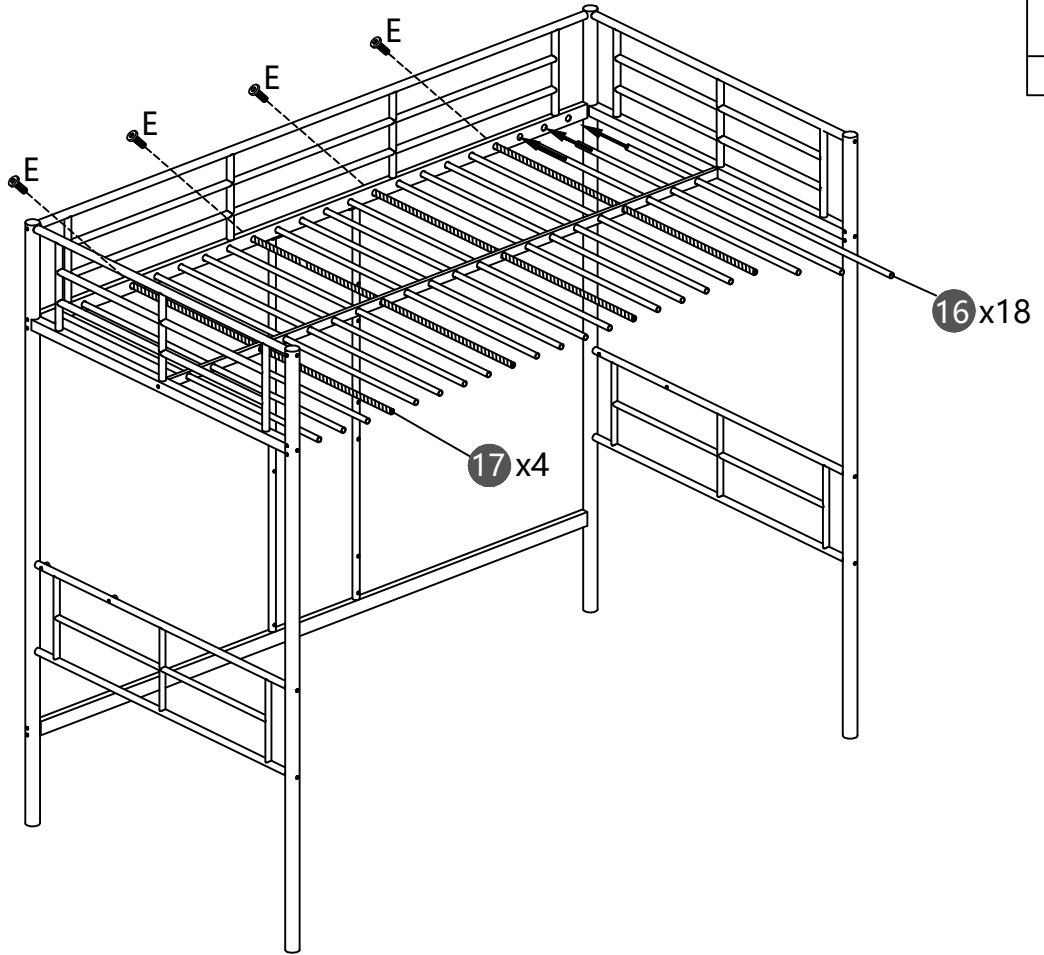



STEP 5:



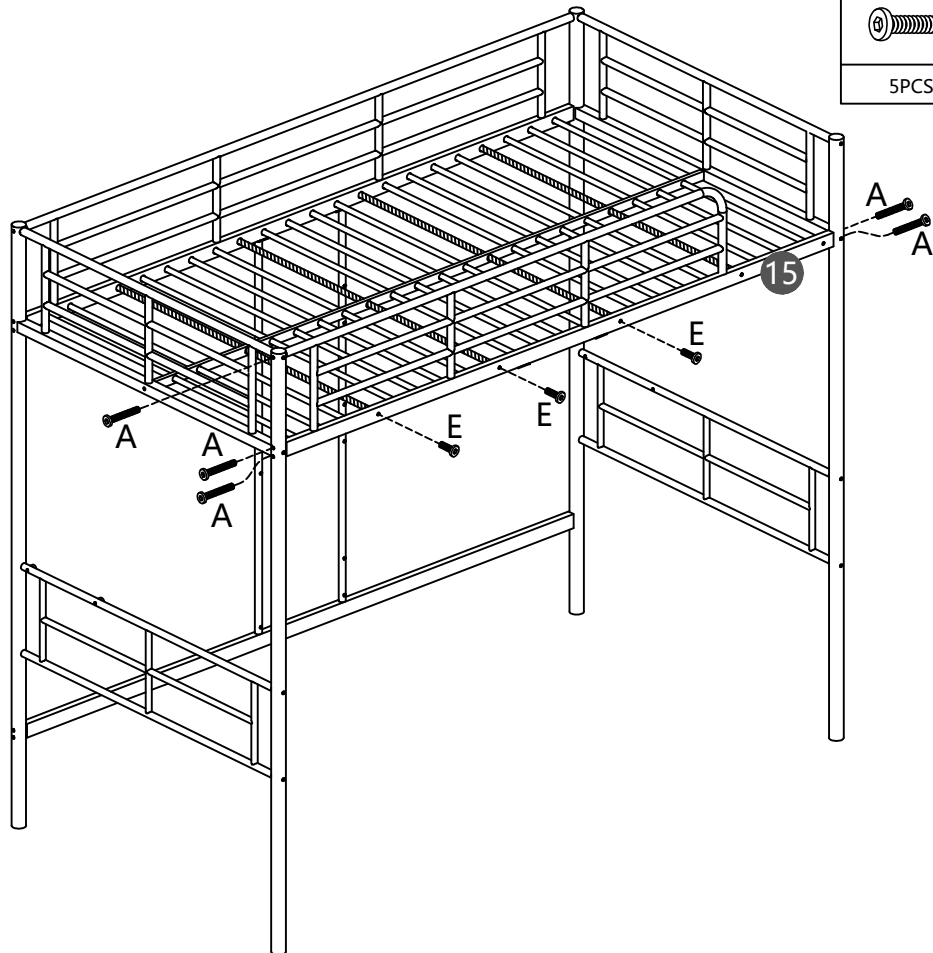

E

4PCS

STEP 6:





A	E
	
5PCS	3PCS

STEP 7:

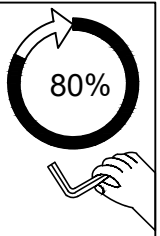
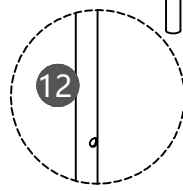
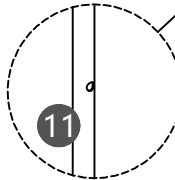
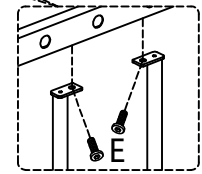
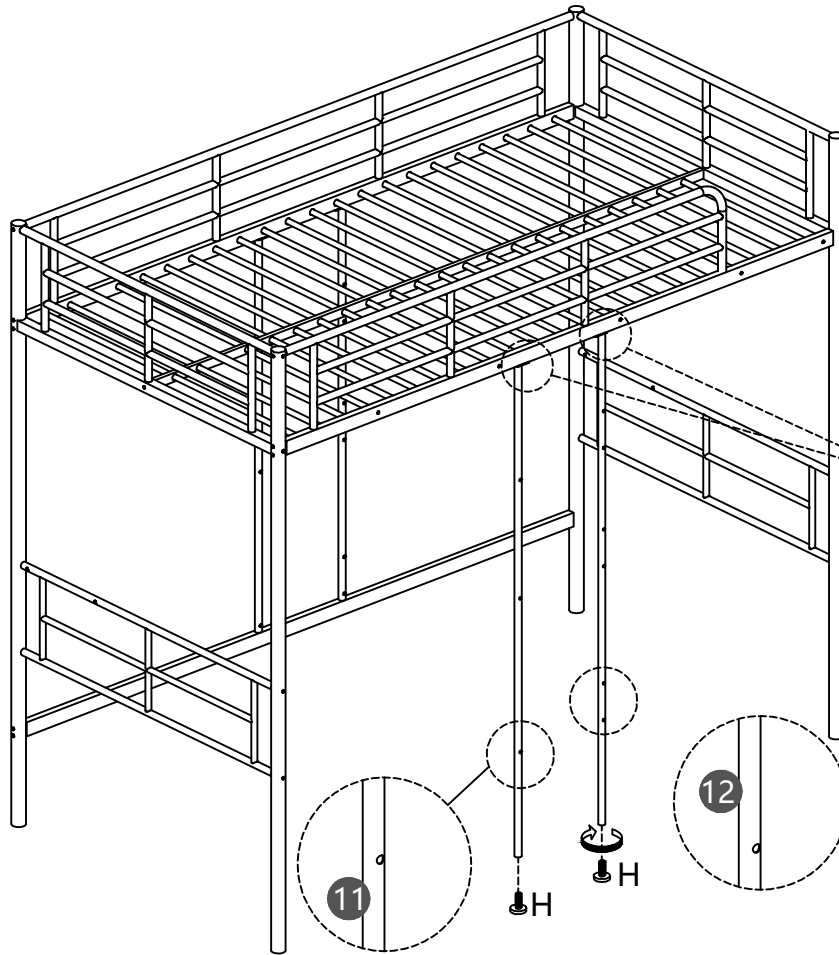
E	H
	
2PCS	2PCS



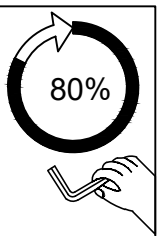
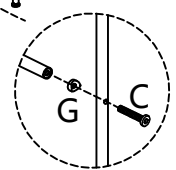
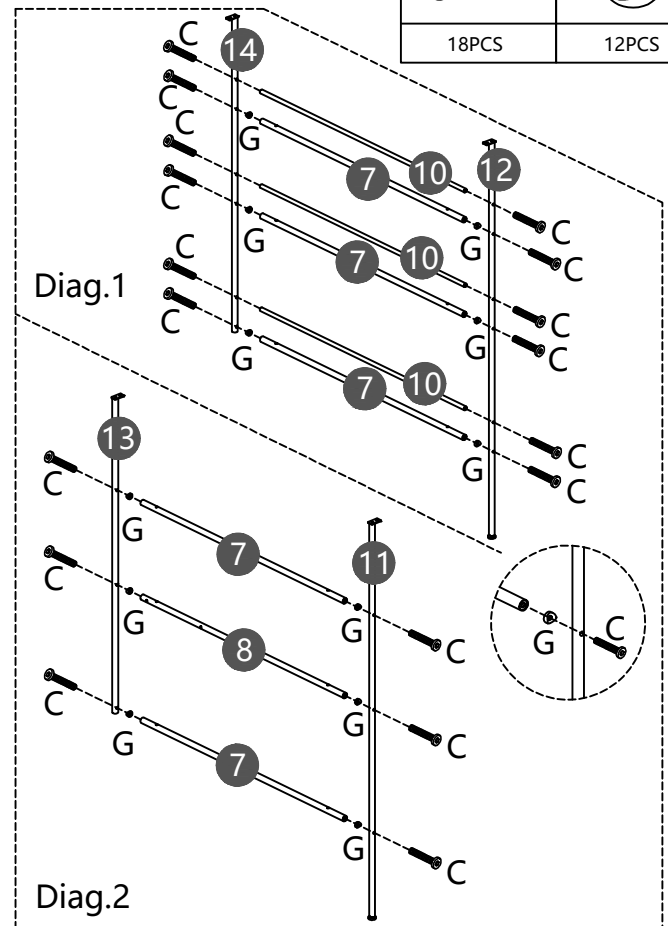
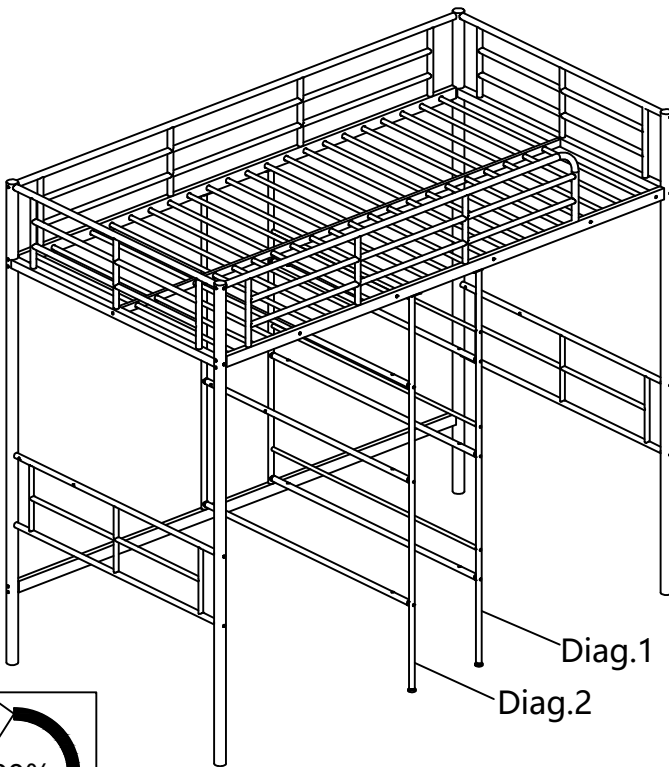

STEP 8:

C	G
	
18PCS	12PCS



STEP 9:

C	G
	
4PCS	4PCS

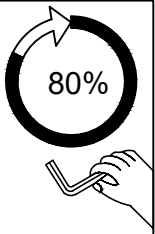
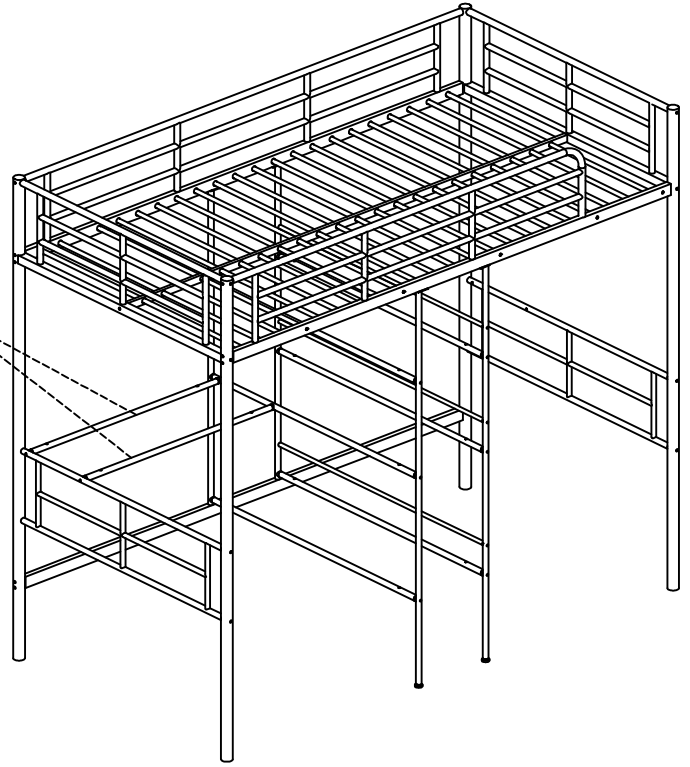
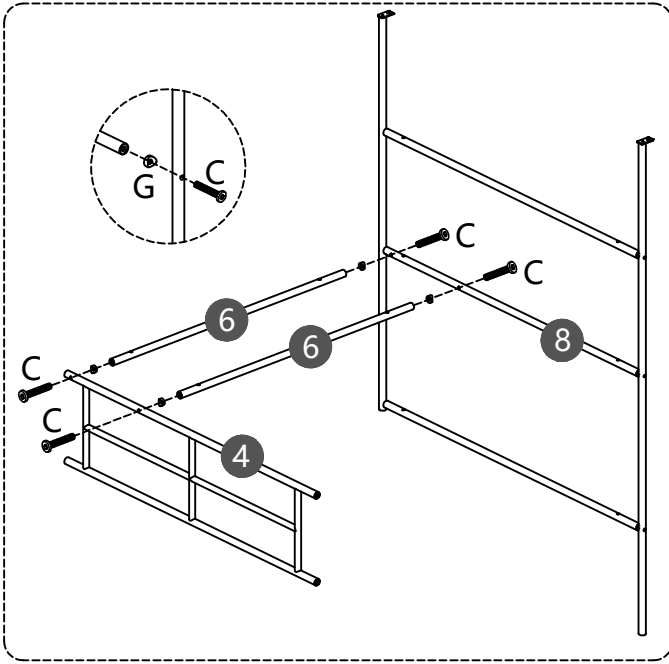

STEP 10:

D

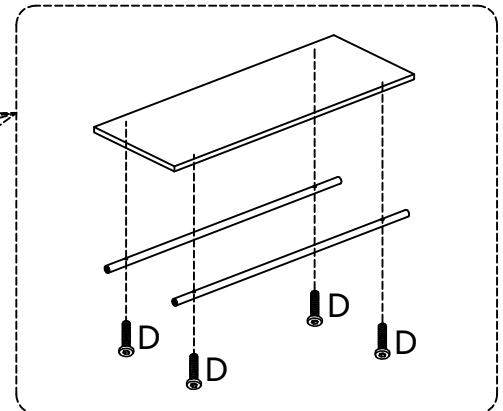
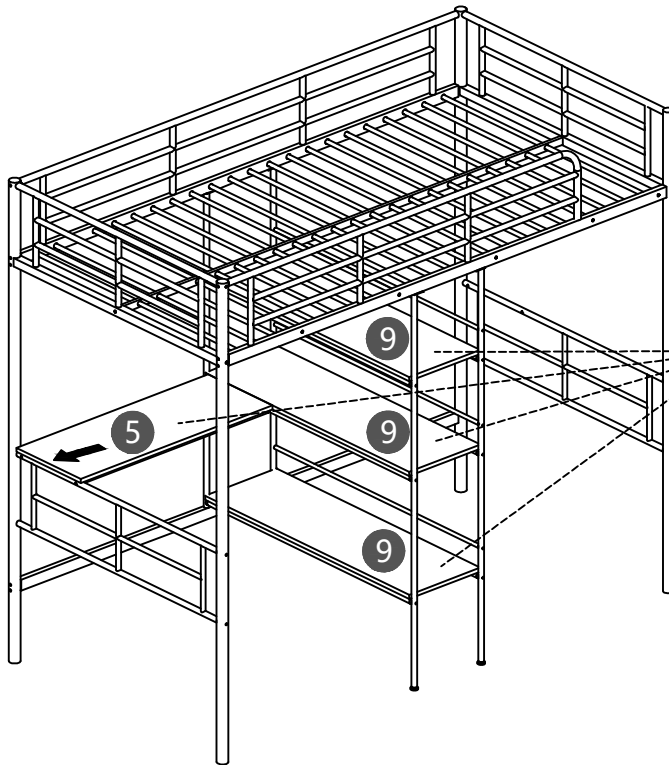
16PCS





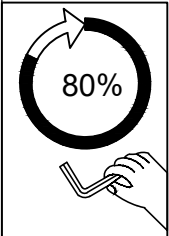
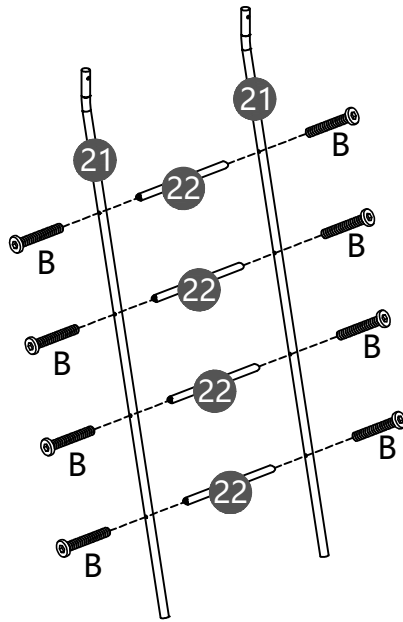

STEP 11:

B

8PCS



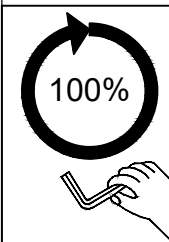
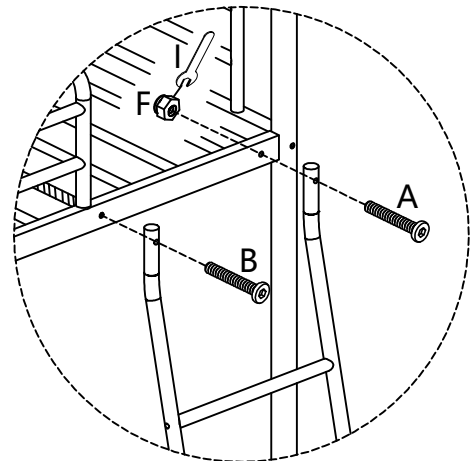
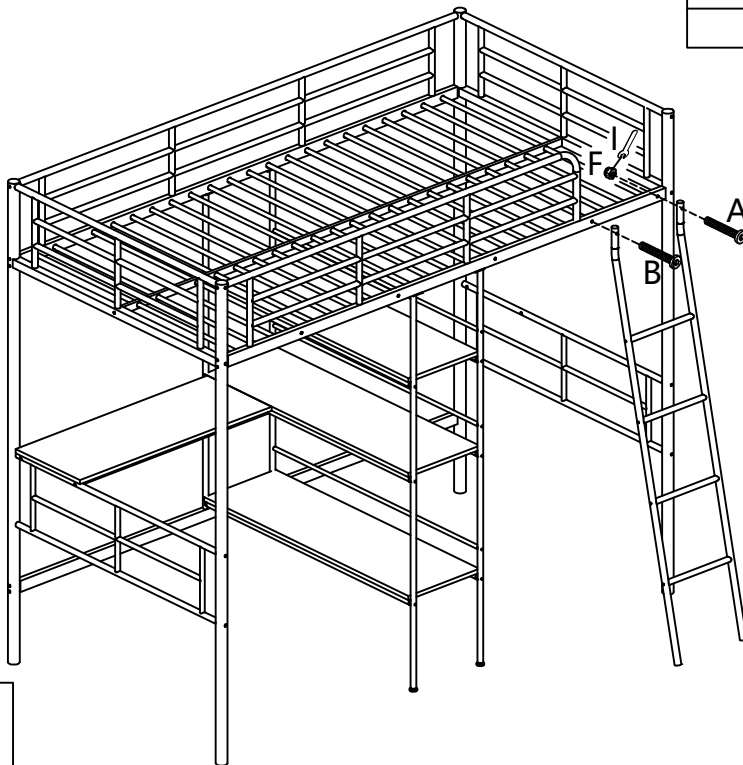

STEP 12:

A	B	F	I
			
1PC	1PC	1PC	1PC



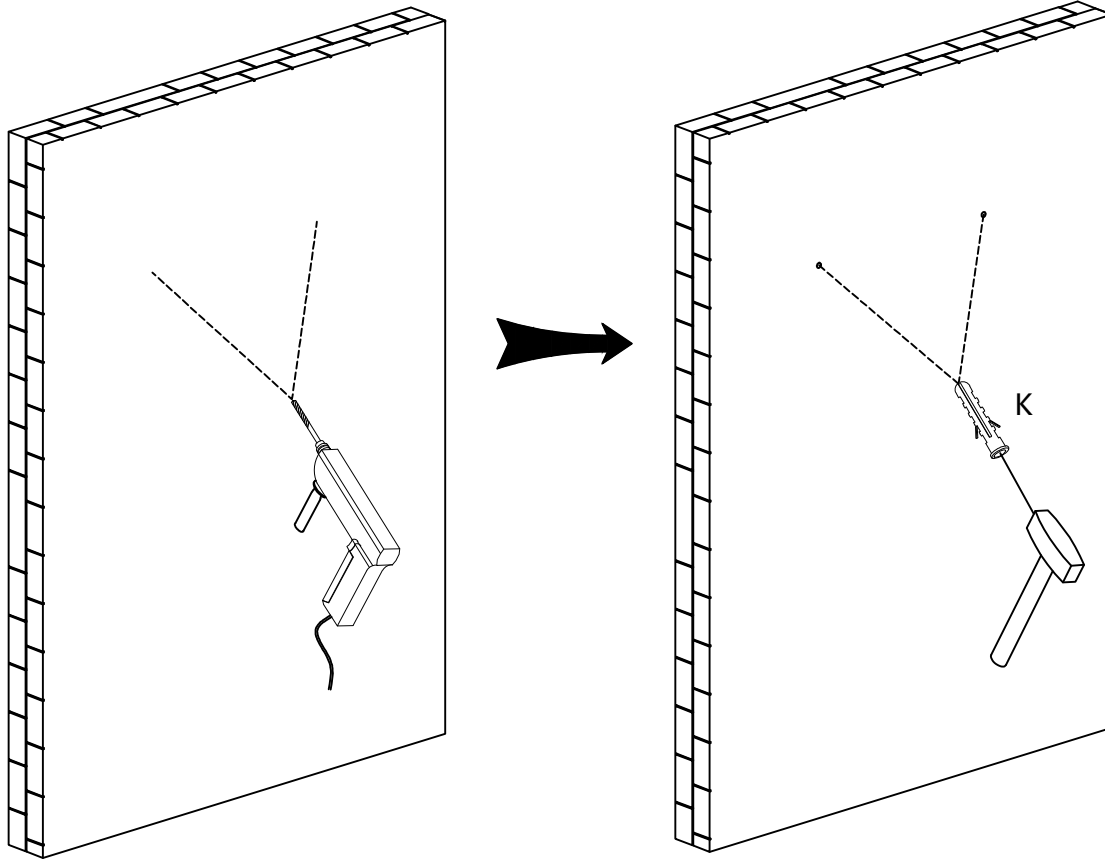

STEP 13:

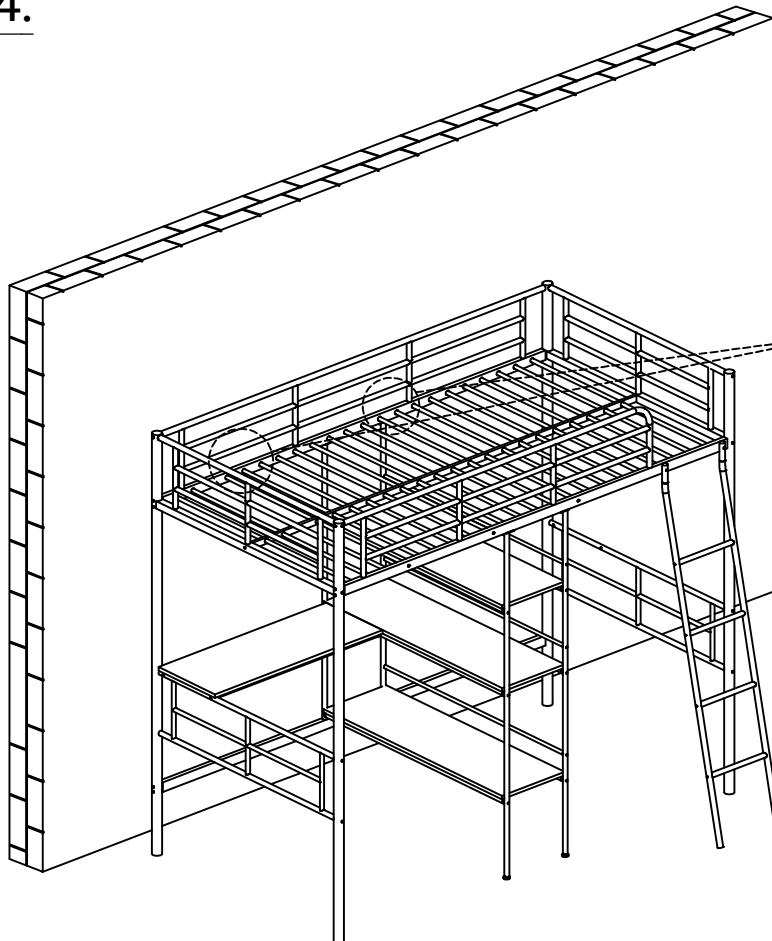

K

2PCS

STEP 14:



L	M
	
2PCS	2PCS

