

ASSEMBLY INSTRUCTIONS

TENT BED

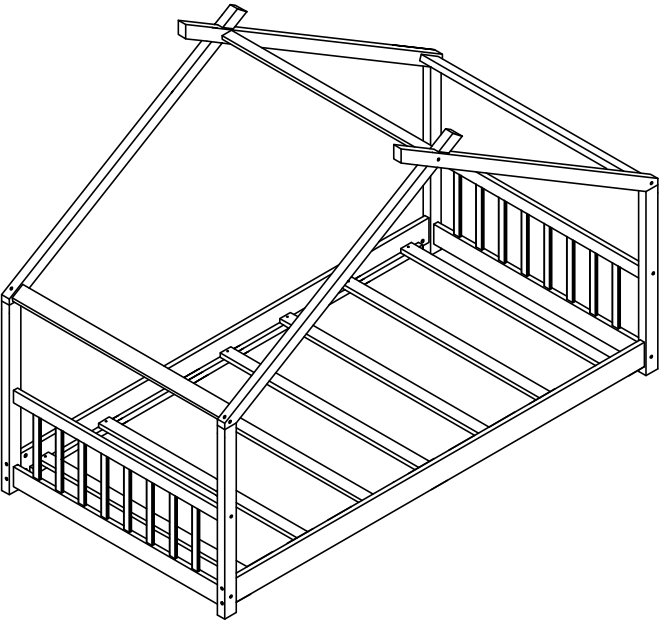





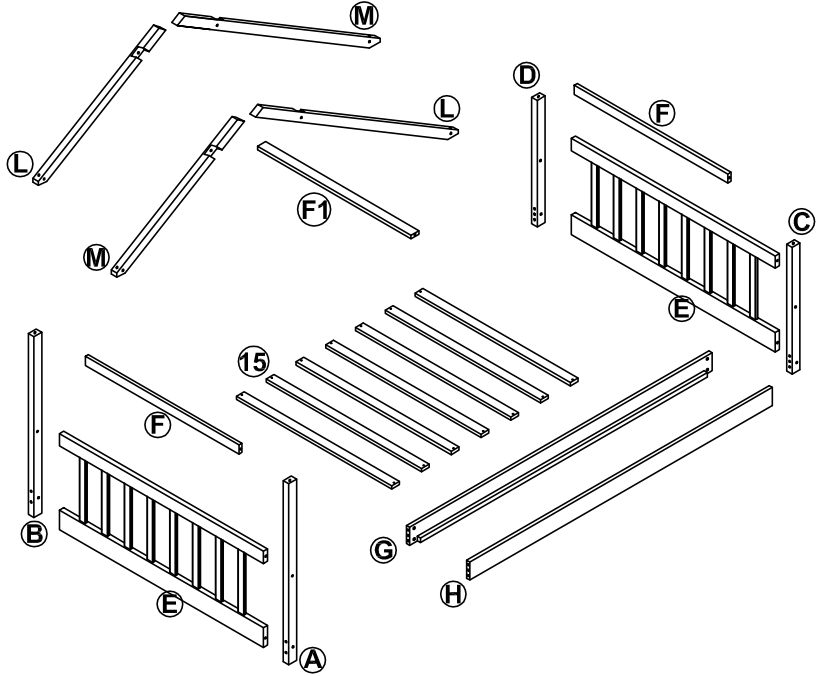



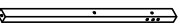
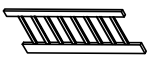

WF284064







Detail View



Part List

A  Front left leg - 1pc	B  Back left leg - 1pc	C  Front right leg - 1pc
D  Back right leg - 1pc	E  Horizontal (lower) - 2pcs	F  Horizontal (upper) - 2pcs
G  Back side rail - 1pc	H  Front side rail - 1pc	15  Slat - 7pcs
M  Cap of back right - 2pcs	L  Cap of back left - 2pcs	F1  Horizontal (upper) - 1pc

Hardware List

1  Ø10*30mm Wood dowel (24pcs)	2  Ø1/4"*110mm Hex-Head bolt (8pcs)	3  Ø1/4" Horizontal-Hole bolt (8pcs)
4  Ø6*70mm Hex-Head screw (18pcs)	6  #4*30mm Screw (14pcs)	8  K4mm Allen key (1pc)



ASSEMBLY TOOLS REQUIRED (NOT INCLUDED)



PLEASE BE CAREFUL DO NOT DAMAGE THE HOLE POSITION WHEN YOU USE POWER TOOLS !

STEP 1: Following below Illustration Assembly FRAME #1.

Using hardware #1 & #4 connect A and B Front-back left leg with E horizontal (lower)
And using hardware #1 & #4 connect C and D Front-back right leg with E horizontal (upper)
to complete FRAME #1L/R.

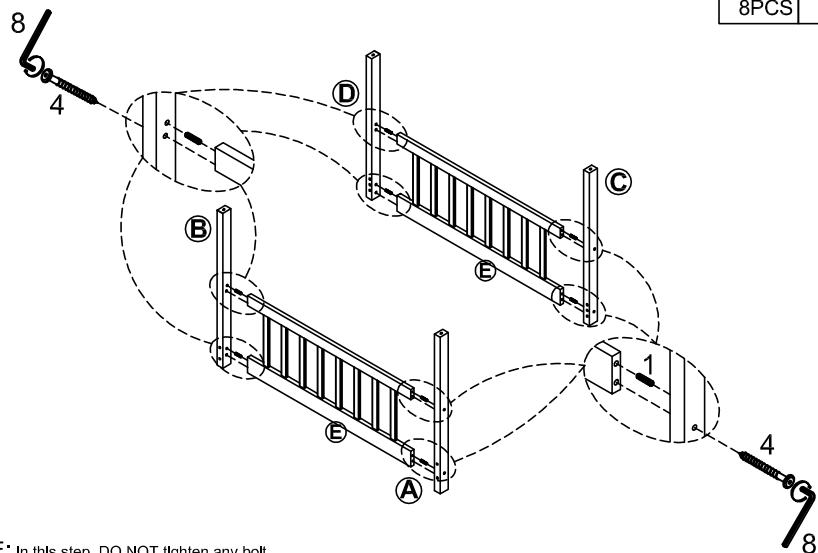

1	4
	
8PCS	8PCS



NOTE: In this step, DO NOT tighten any bolt until you connect all part together

STEP 3: Following below illustration Assembly FRAME #3.

Using hardware #1, #2 & #3 connect FRAME #1L/R (A, B, C, D Left-right leg frame) with G and H Side rail to complete FRAME #3.

1	2	3
		
4PCS	8PCS	8PCS

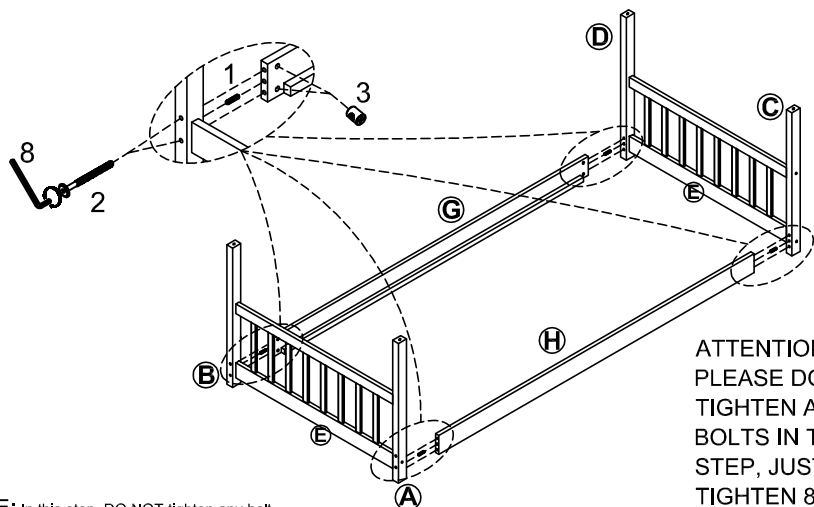



ATTENTION:
PLEASE DON'T
TIGHTEN ALL
BOLTS IN THIS
STEP, JUST
TIGHTEN 80%

NOTE: In this step, DO NOT tighten any bolt until you connect all part together

5

STEP 4: Following below Illustration Assembly FRAME #4.

Using hardware #4 connect the Cap J, K, L and M with F horizontal (upper) to complete FRAME #4.

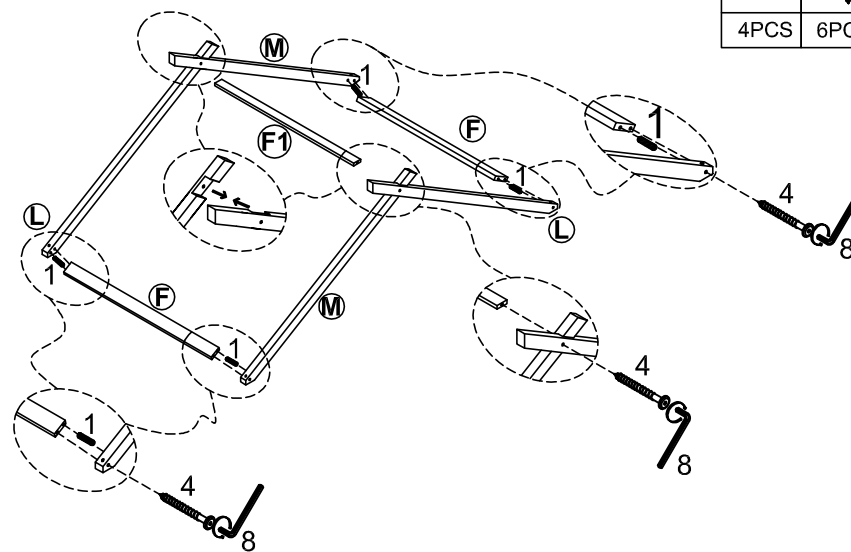

1	4
	
4PCS	6PCS



NOTE: In this step, DO NOT tighten any bolt until you connect all part together

STEP 6: Following below illustration Assembly FRAME #6.

Move the FRAME #4 to put on the Leg A, B, C and D
Using hardware #4 connect all the Leg A, B, C and D with F horizontal (upper) to complete FRAME #6.

4	
4PCS	
1	
8PCS	

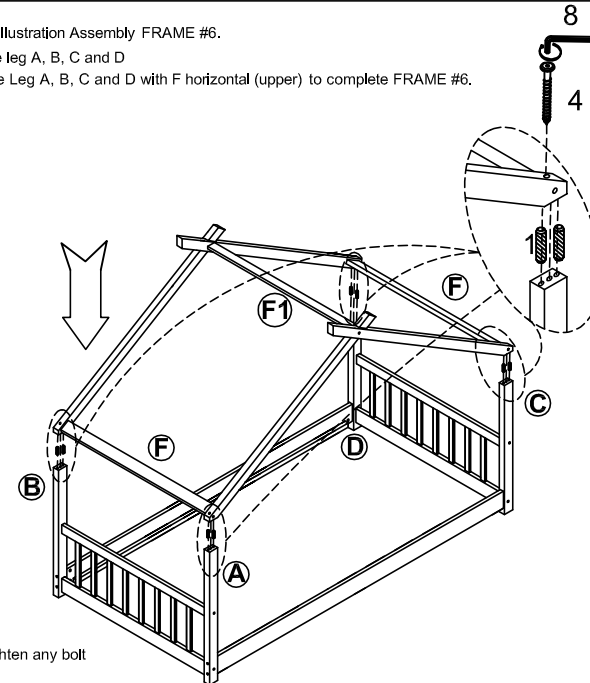

NOTE: In this step, DO NOT tighten any bolt until you connect all part together

6

STEP 7: Following below illustration Assembly FRAME #7.

Using hardware #6 connect to screw all Wood slats 15 with FRAME #5 on all the Bed.
to complete FRAME #7.

WARNING!

Please completed screw all the slats in to side rails before using.

6



14PCS

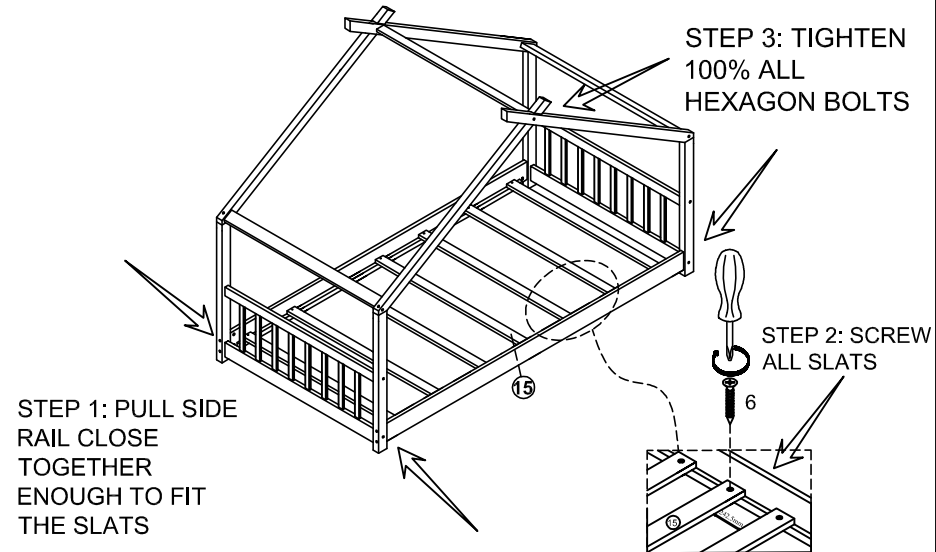

COMPLETED

