

Full Length Mirror

Instruction Manual

MI-GZ-1659

MI-GZ-2164N

MI-GZ-3071N

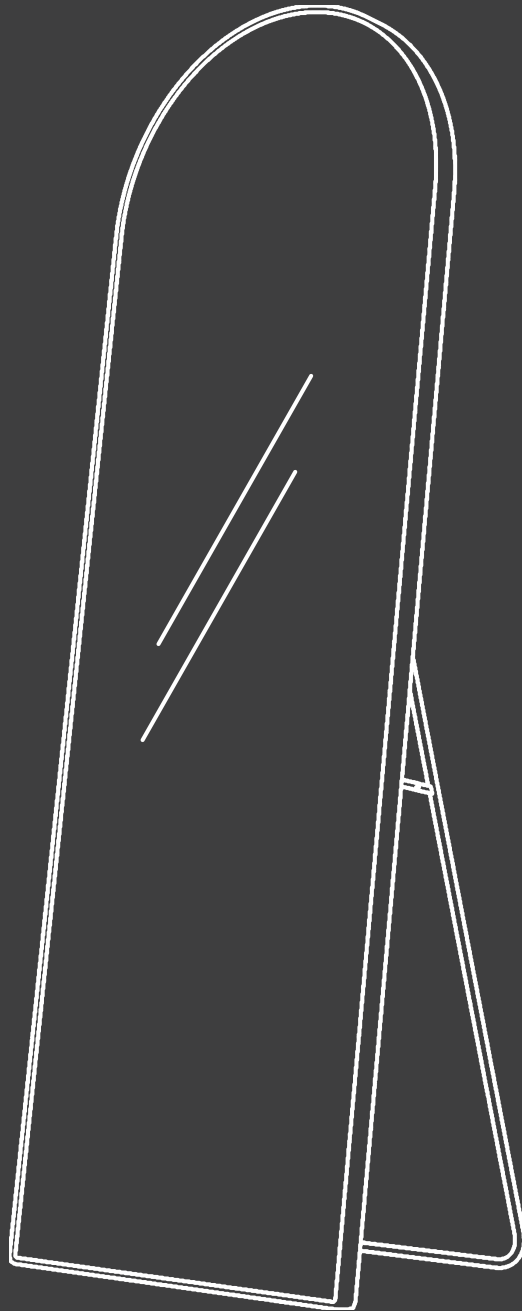

 EST 9:00AM--17:00PM

 HJ-Customer-Service@outlook.com

 (909)637-7665 | (909)637-7593

1 Before Assembly

Assembly Tips

- Check the list of contents before assembly to ensure that all parts are included in the package.
- Make sure the wall can bear the weight of the mirror.
- Do not use string or chain to hang the products.

Care Advice

- Before using, clean with warm water and a soft, lint-free cloth.
- Check all the screws and bolts are tight every three months or as needed.
- Clean with an ammonia-free glass cleaner or detergent.
- Avoid spraying cleaners directly onto the mirror.

2 Package List

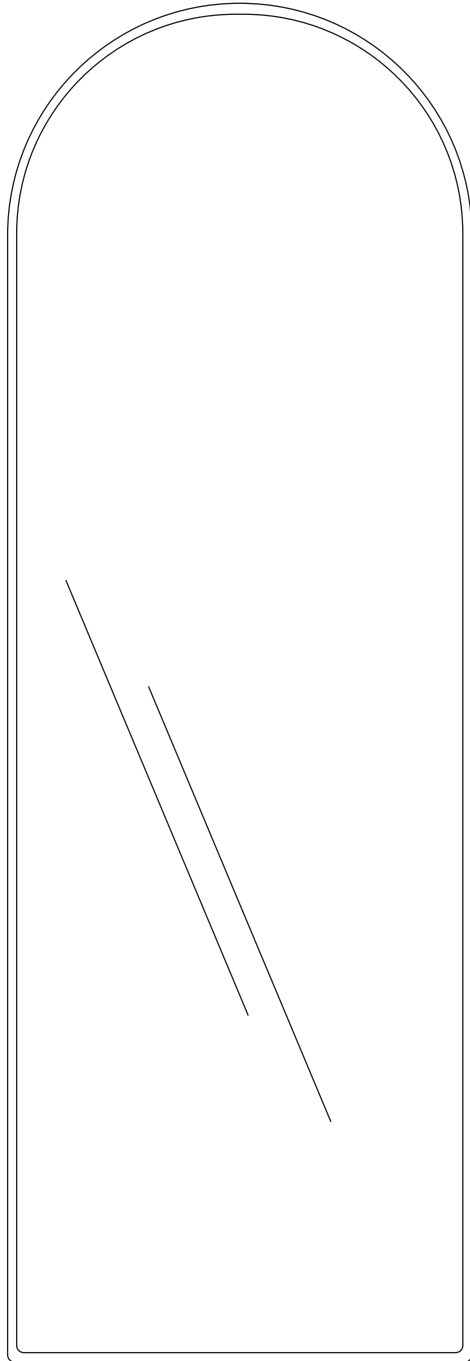

Mirror
x1

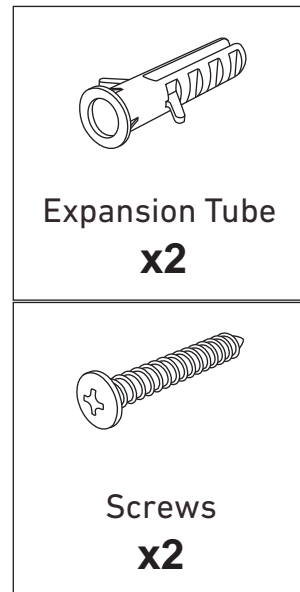

Tools Required (Not Provided)



3 Usage Method

Standing

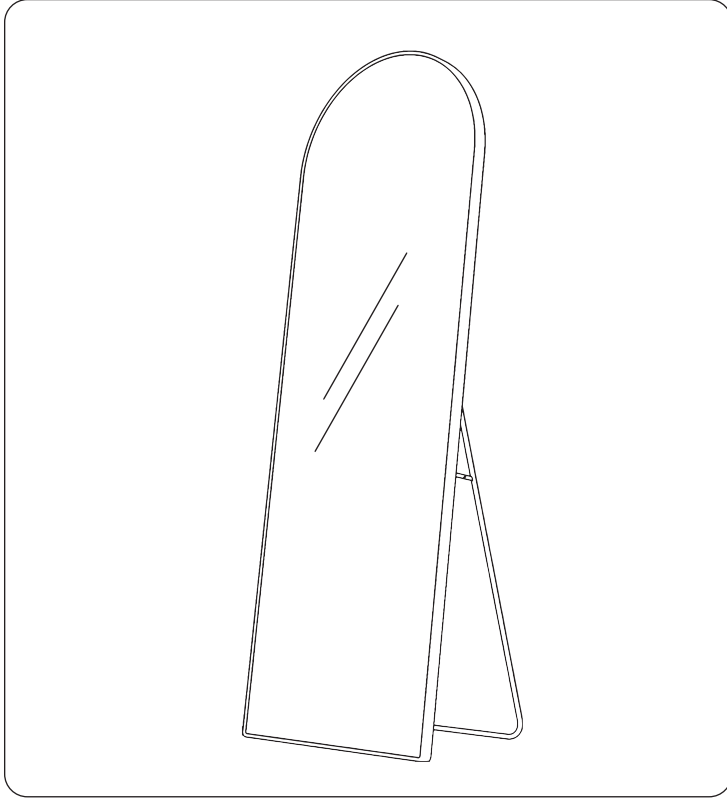

Leaning

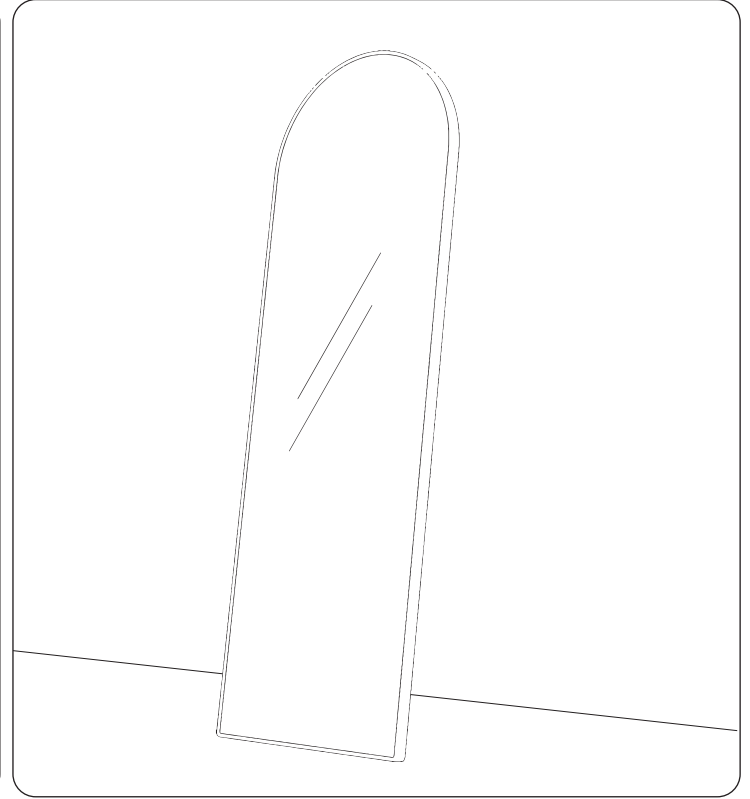

Hanging

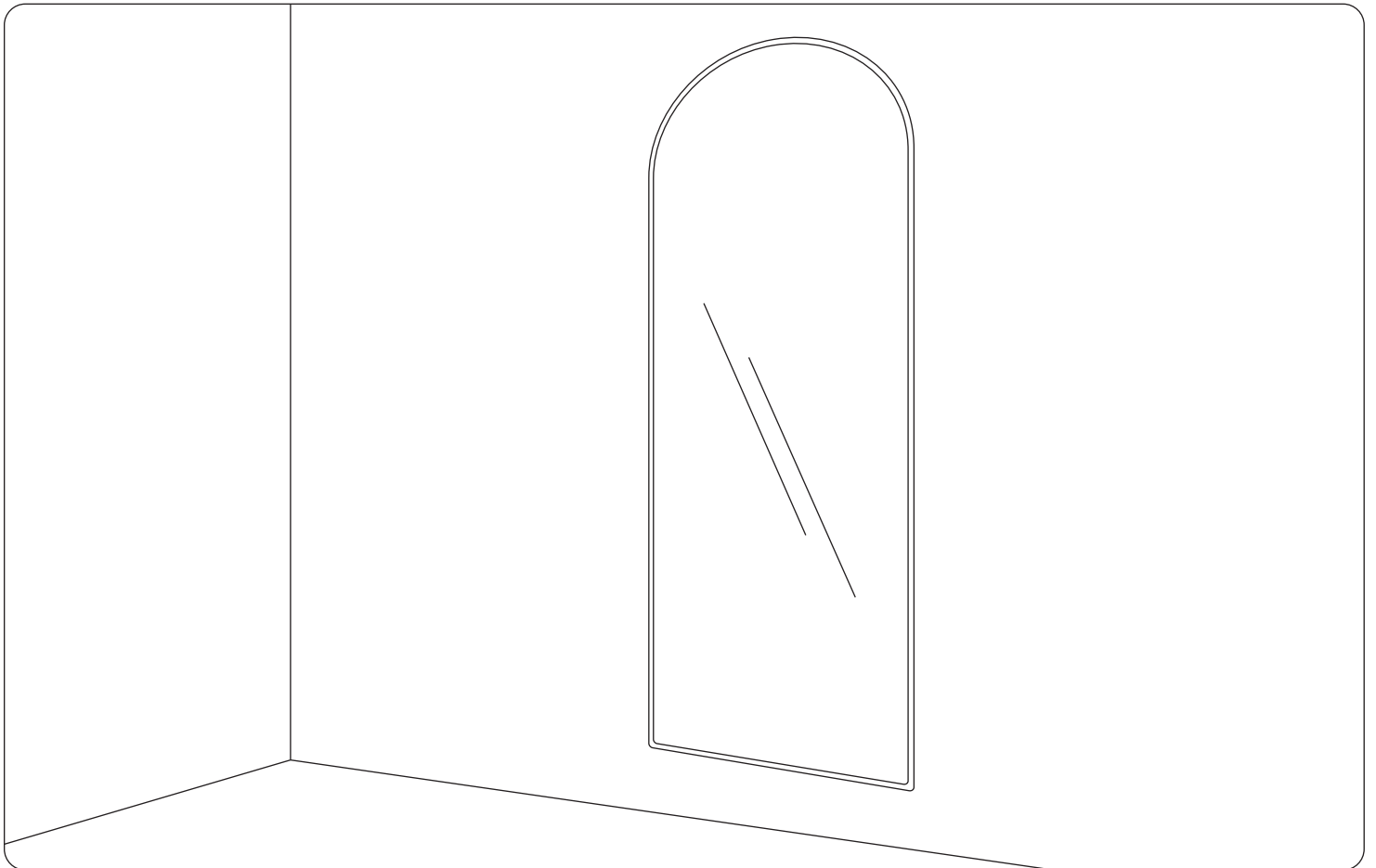

Step 1

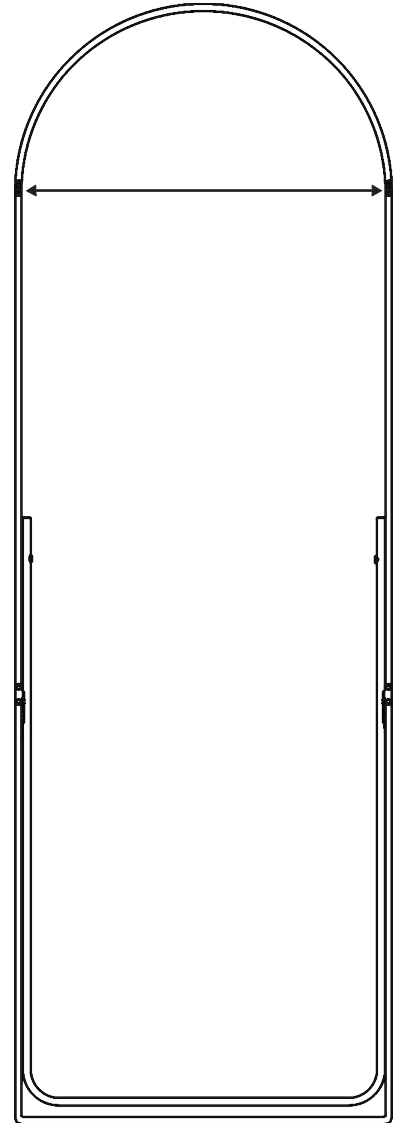
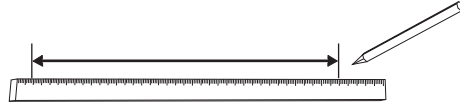

Use a ruler to accurately measure the distance between the mirror's two hooks, then measure and mark the same distance on the wall. Make sure they match perfectly.

Step 2

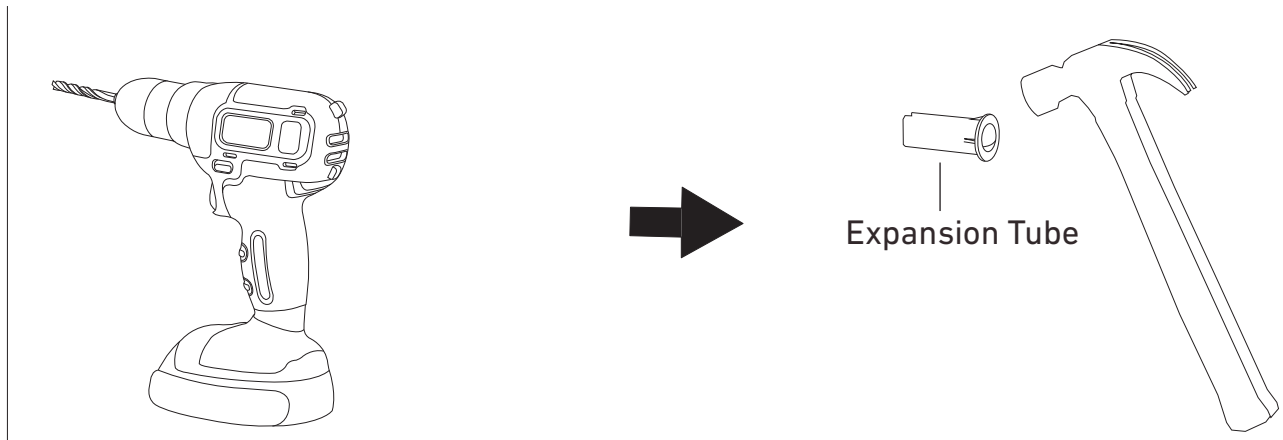

Drill holes at the marked positions on the wall. Hammer the Expansion Tube into the holes.

Step 3

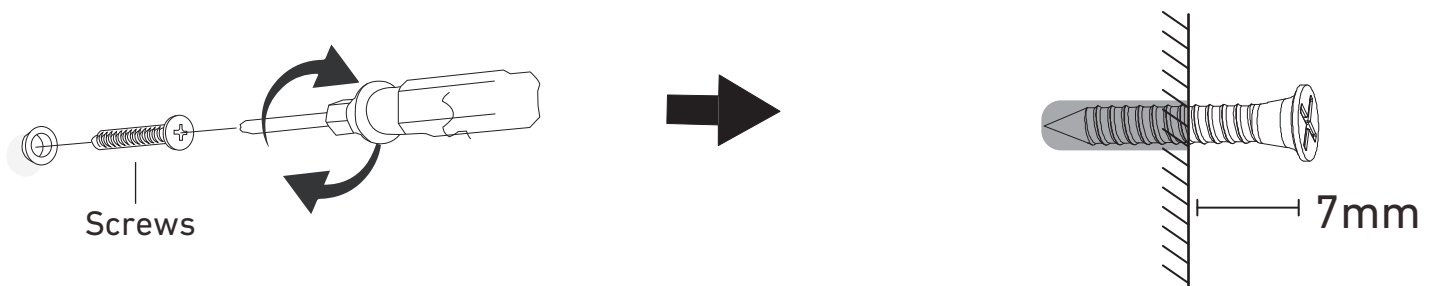

Fix the Screws into the Expansion Tube, leaving about **7mm** of the screws exposed.

Step 4



Hang the Mirror on the wall.

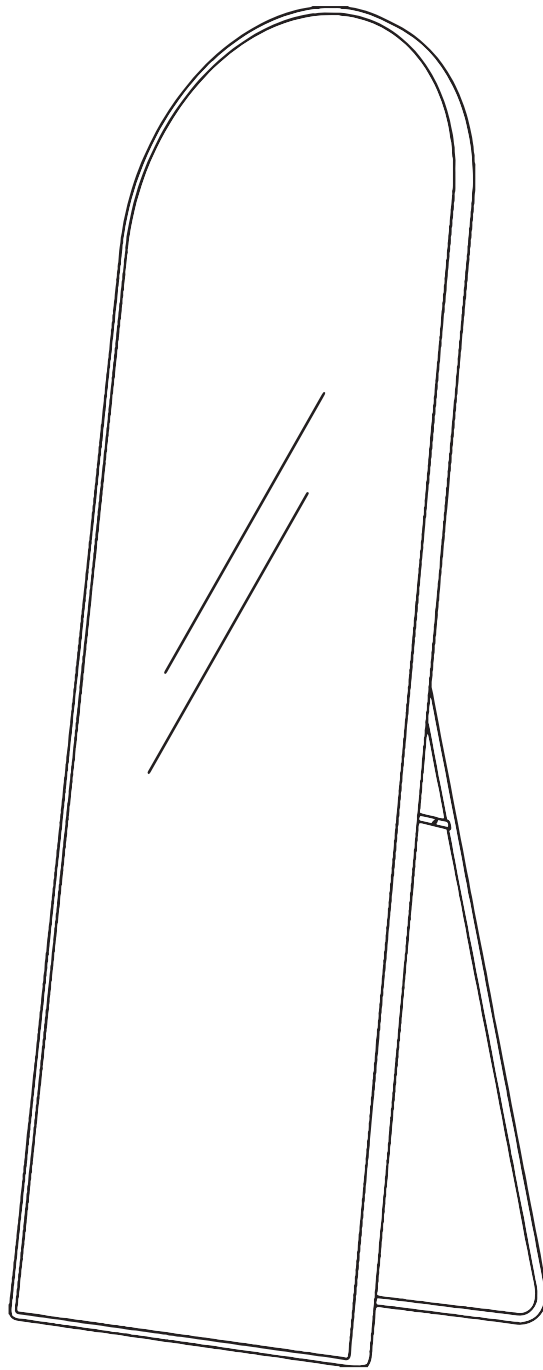

Technical Support

(909)637-7665 | (909)637-7593

Other Info

HJ-Customer-Service@outlook.com

Thank you for choosing this product. We strive to provide you with the best quality products and service in the industry. Should you have any issues, please don't hesitate to contact us.