

ASSEMBLY INSTRUCTION

ITEM#: 202708 202709 202710 11401

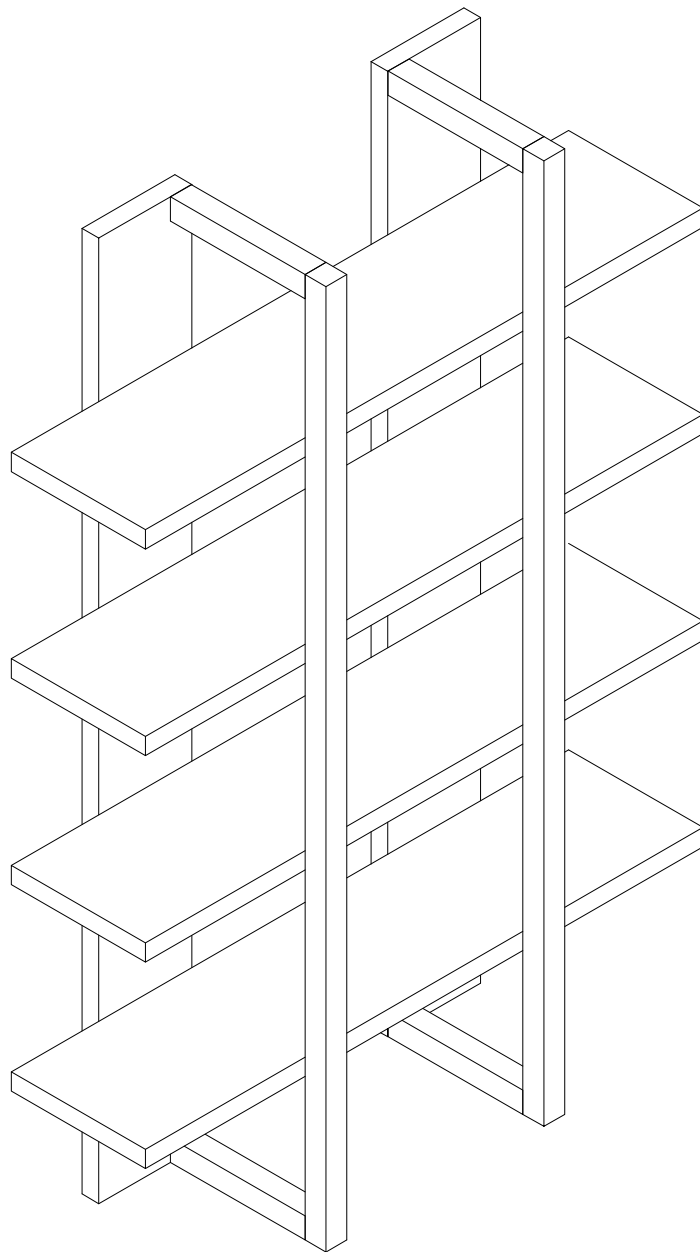

ASSEMBLY INSTRUCTION

PLEASE READ BEFORE ASSEMBLING!

Tip #1: Make sure you've taken all the pieces and hardware out of its packaging before discarding the box.

Tip #2: Using page 2 and/or page 3 of instruction manual make sure all pieces and hardware are accounted for.

Tip #3: Read manual before assembling, it helps!

ITEM#: 202708 202709 202710 11401

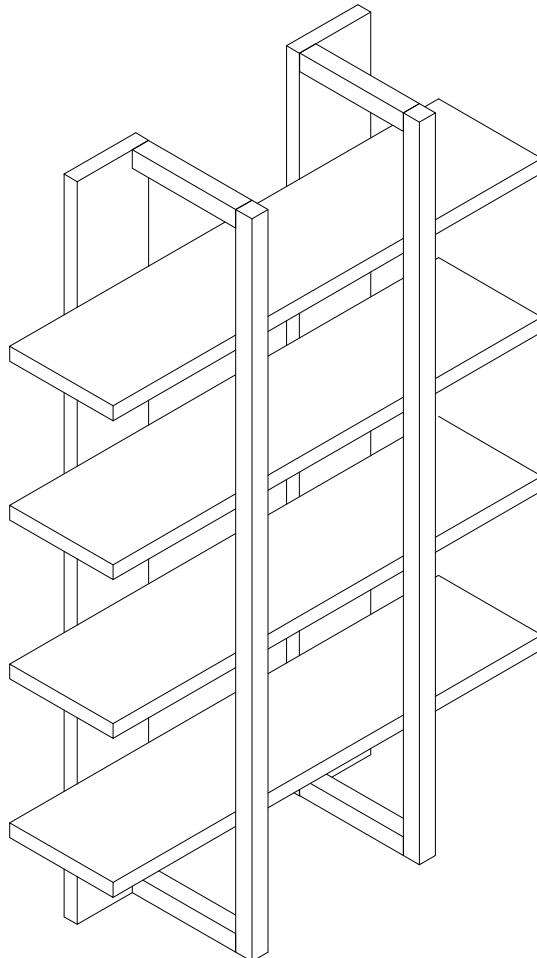

PARTS IDENTIFICATION



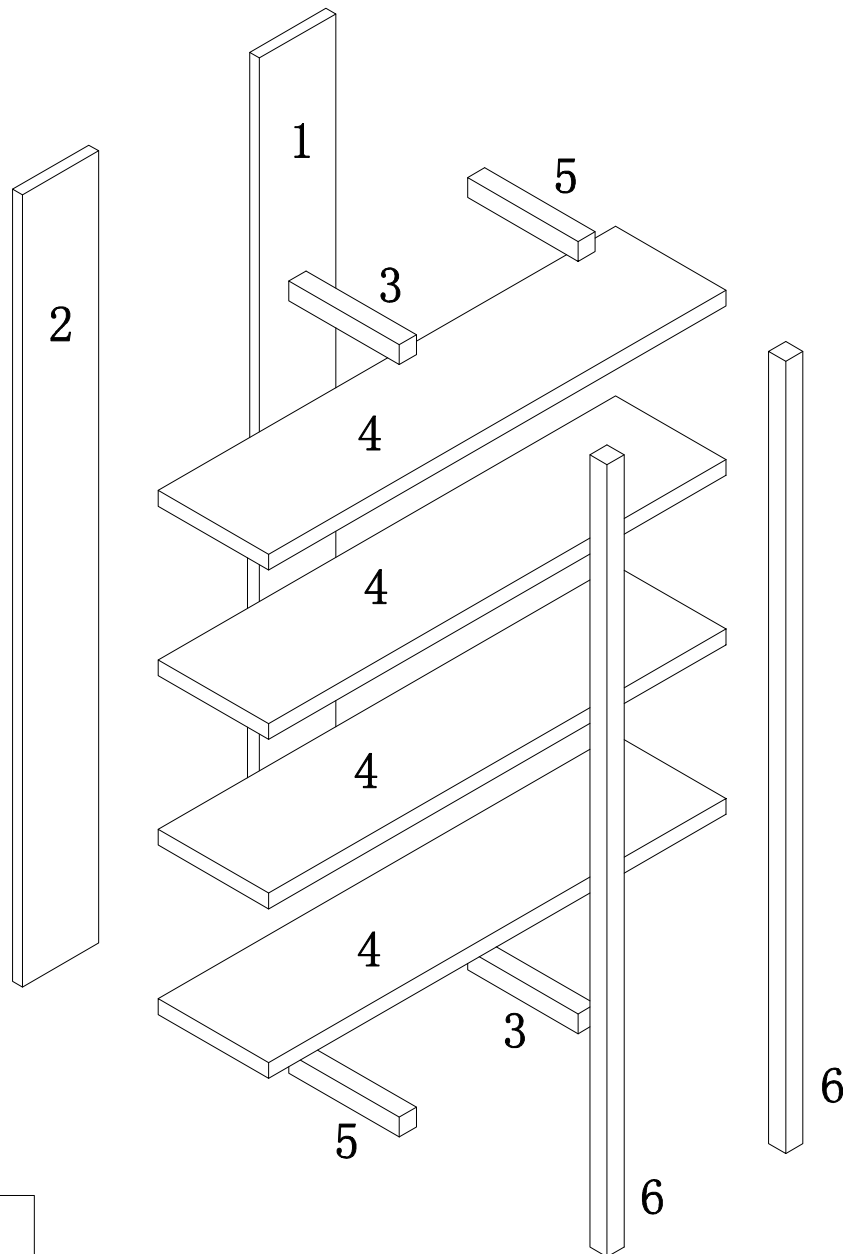







ITEM#: 202708 202709 202710 11401

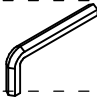

- (1) 1pc
- (2) 1pc
- (3) 2pcs
- (4) 4pcs
- (5) 2pc
- (6) 2pc

HARDWARE IDENTIFICATION

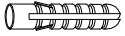
ITEM#: 202708 202709 202710 11401

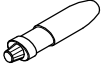
A		$\phi 15$	12pcs
B		L29	12pcs
C		$\phi 8 \times 25$	24pcs
D		$\phi 7 \times 68$	16pcs
E		M4	1pc
F		M6x85	4pcs
G		$\phi 10 \times 15$	4pcs
I		$\phi 5 \times 40$	2pcs
J		$\phi 8 \times 40$	2pcs
K		$\phi 4 \times 25$	2pcs
L		$40 \times 20 \times 15$	2pcs
M		Glue: For securing please apply to wood dowel first before inserting into panel	1pc

ASSEMBLY INSTRUCTION

ITEM#: 202708 202709 202710 11401

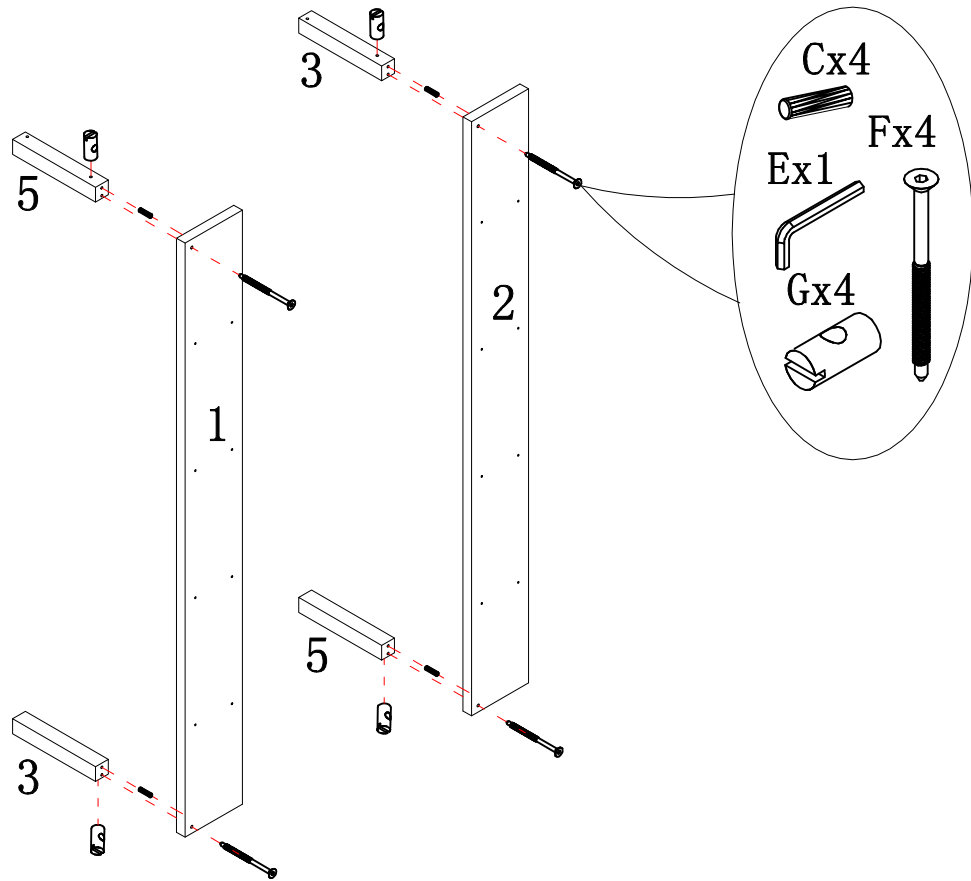

STEP 2

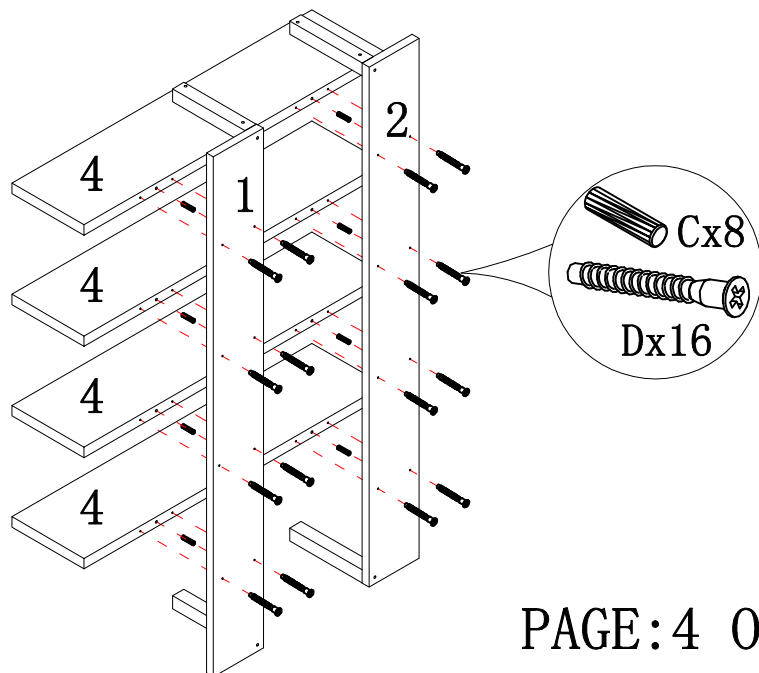

ASSEMBLY INSTRUCTION

ITEM#: 202708 202709 202710 11401

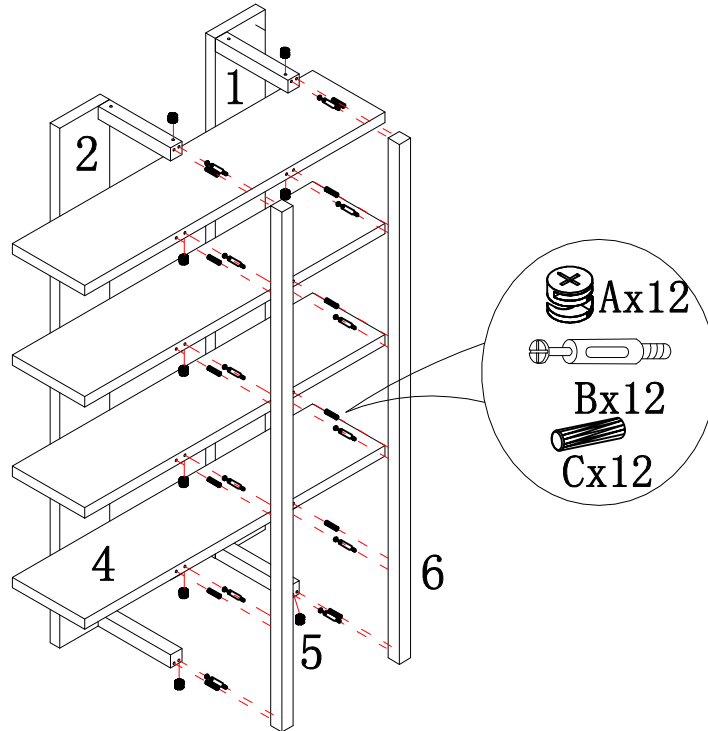

STEP3

STEP4

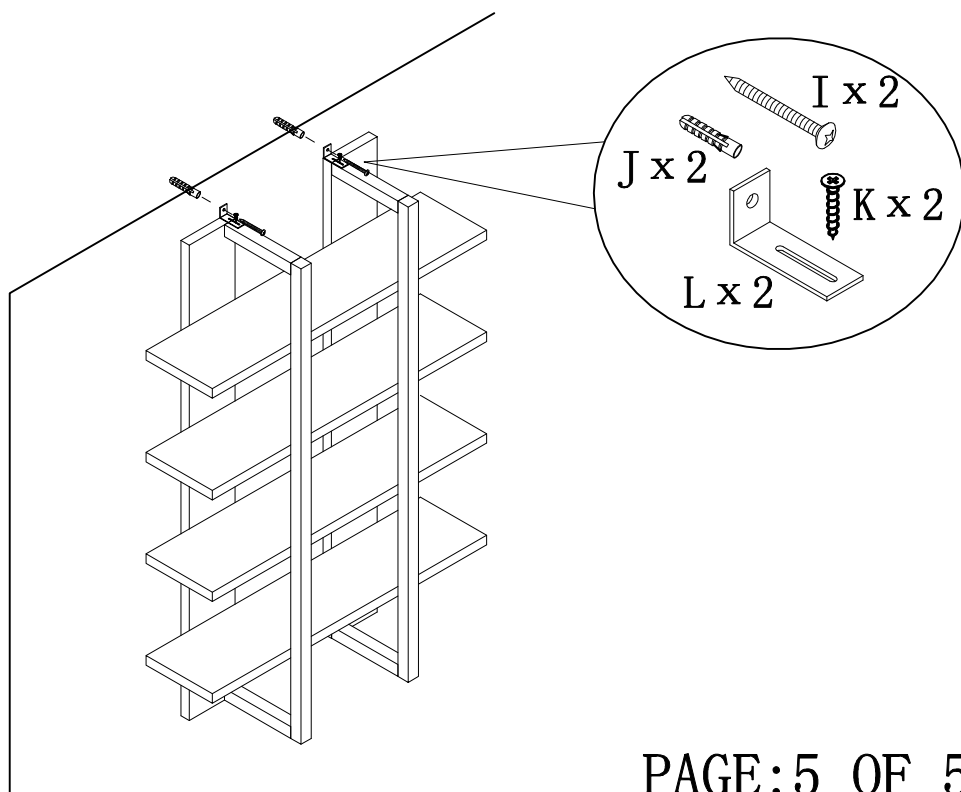

PAGE:5 OF 5