

Assembly Instructions

Nightstand

Precautions:

1. It is recommended to wear gloves for assembly to protect hands from injury,
2. When assembling, please strictly follow the installation direction and order in the instruction manual.
3. Tighten the screws after two or more parts have been successfully assembled, Tightening the screws early will cause the parts to be disassembled and reassembled.
4. Please place all parts correctly to avoid unnecessary trouble.



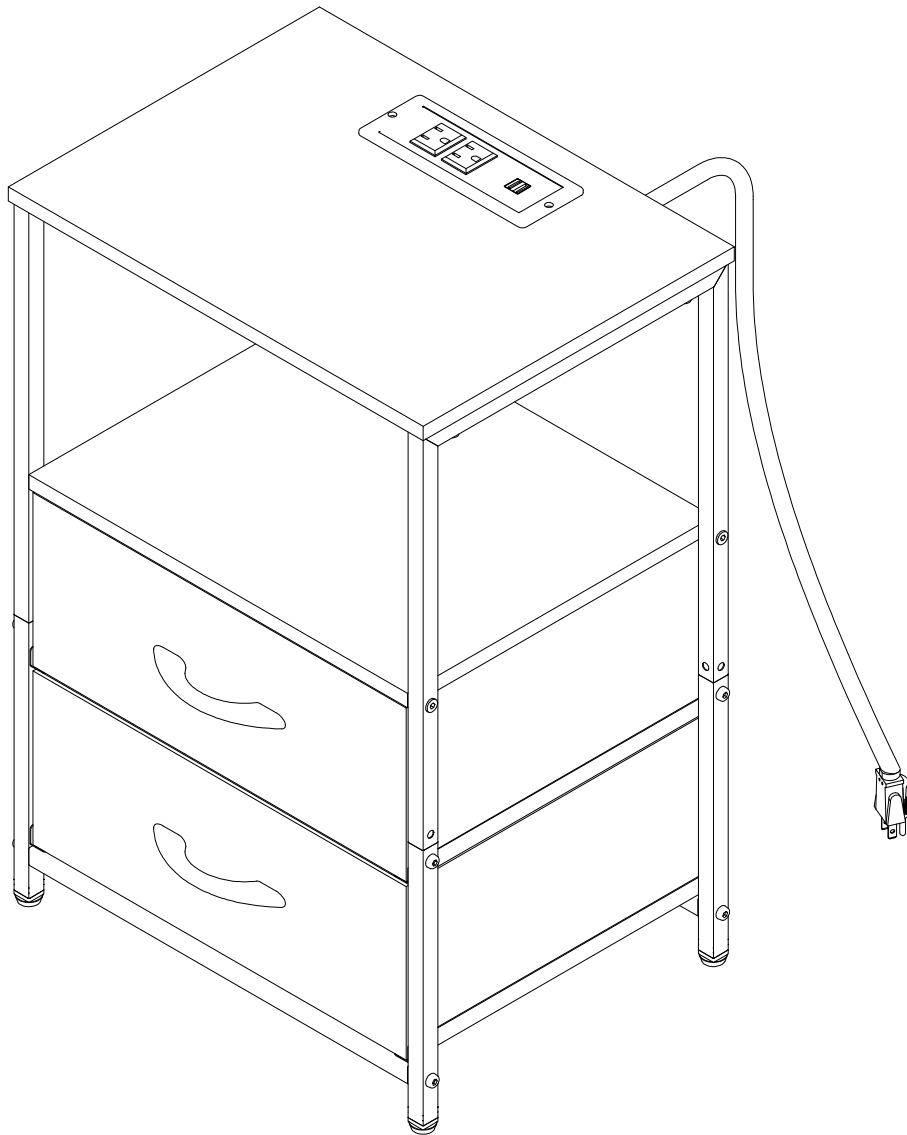

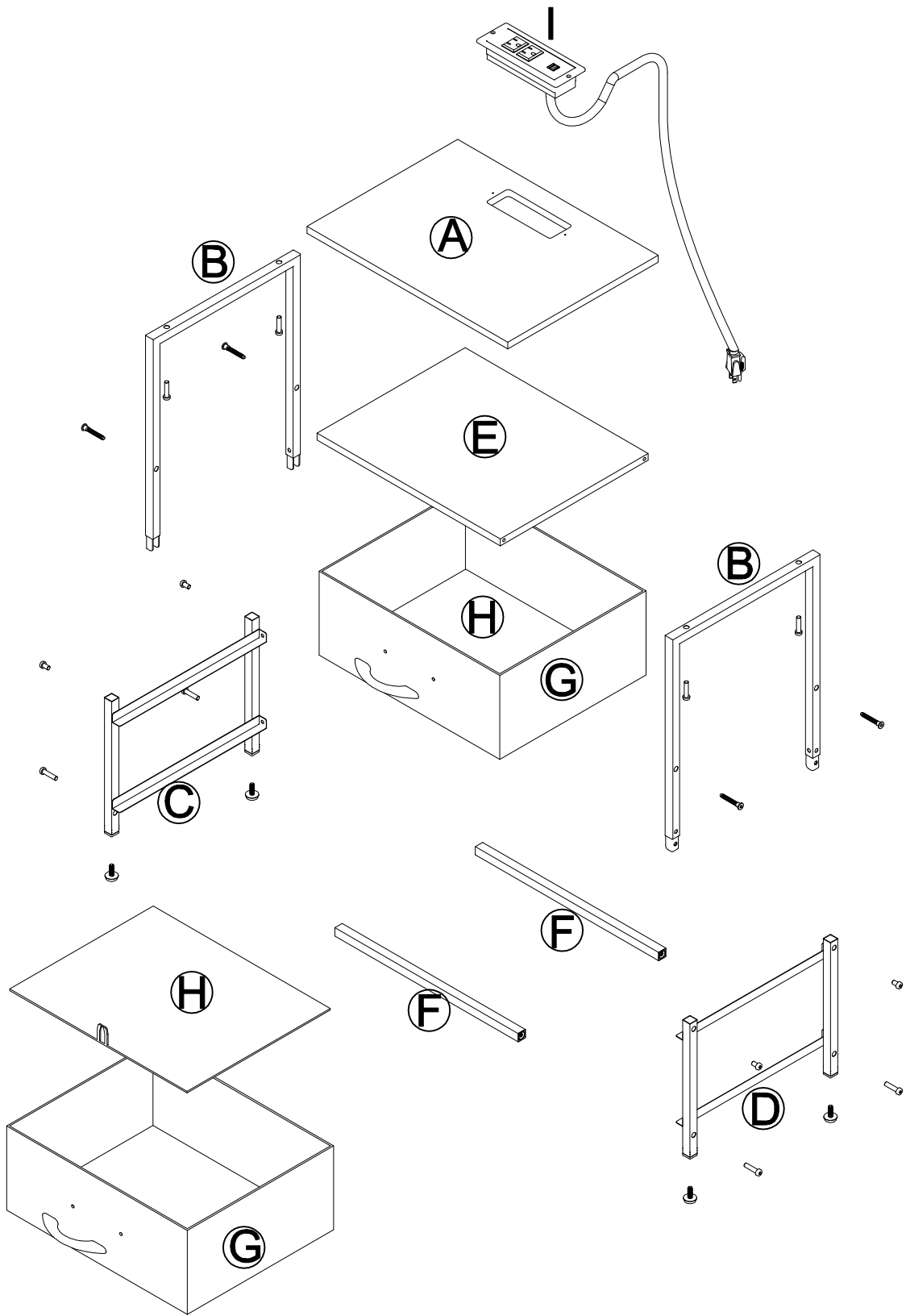
Thank you for your patience in reading,. Wish you a happy life!

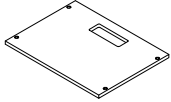
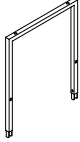
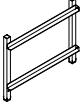
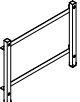
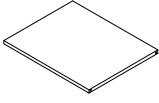

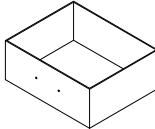
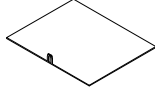
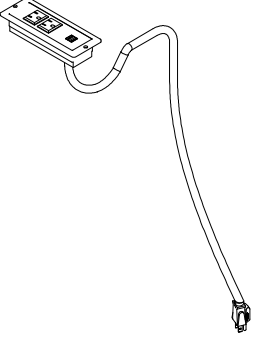

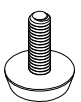

#		QTY
A		1
B		2
C		1
D		1
E		1

#		QTY
F		2
G		2
H		2
I		1

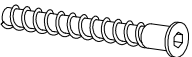
#		QTY
①	 M6*15	x 4
②	 M6*23	x 8
③		x 2
④	 M3*10	x 2

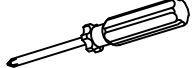
#		QTY
⑤	 M6*10	x 4
⑥	 M6*40	x 4
⑦	 M4*8	x 4
⑧	 M4	x 1
	 (NO INCLUDED)	x 1

Step 1

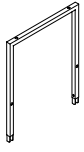

B x 2

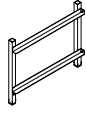

C x 1

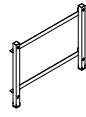

D x 1

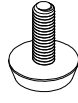

1 x 4



5 x 4



8 x 1

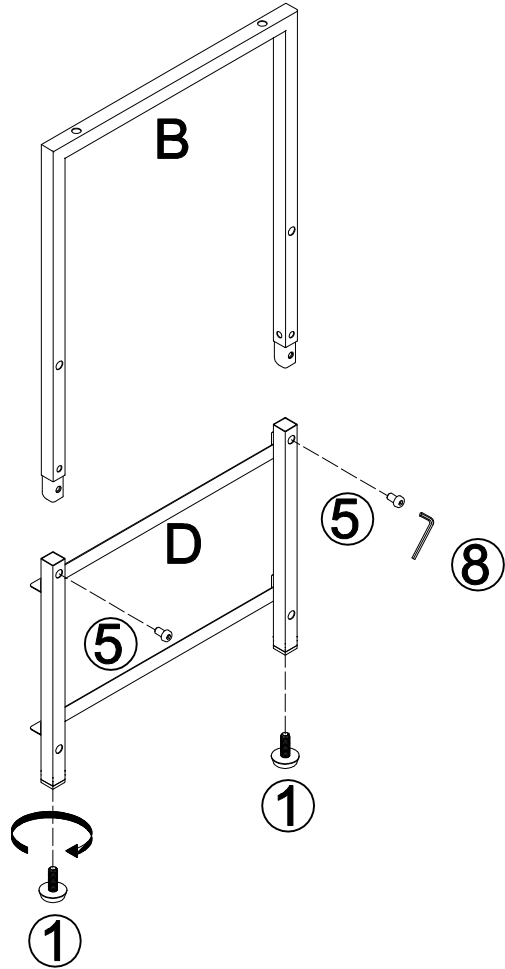
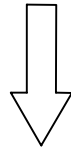
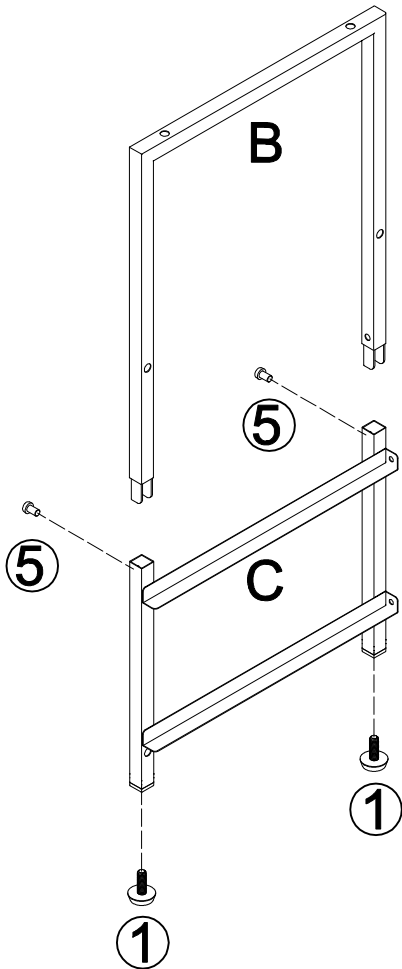

Step 2

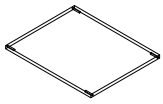

E x 1



F x 2



② x 4

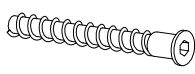

⑥ x 4



⑧ x 1

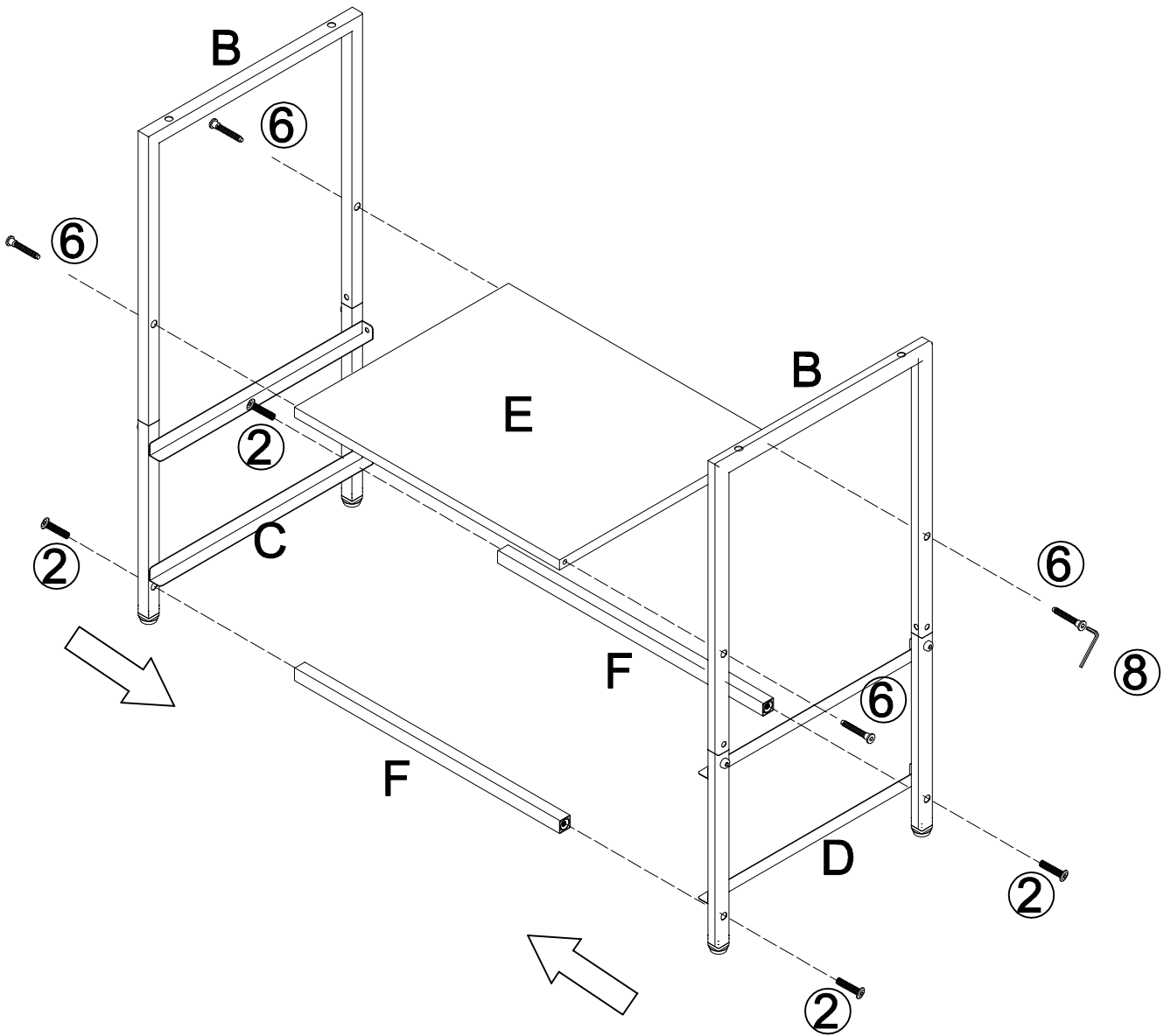

Step 3

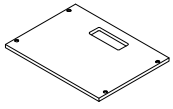

A x 1



2 x 4

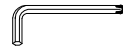

8 x 1

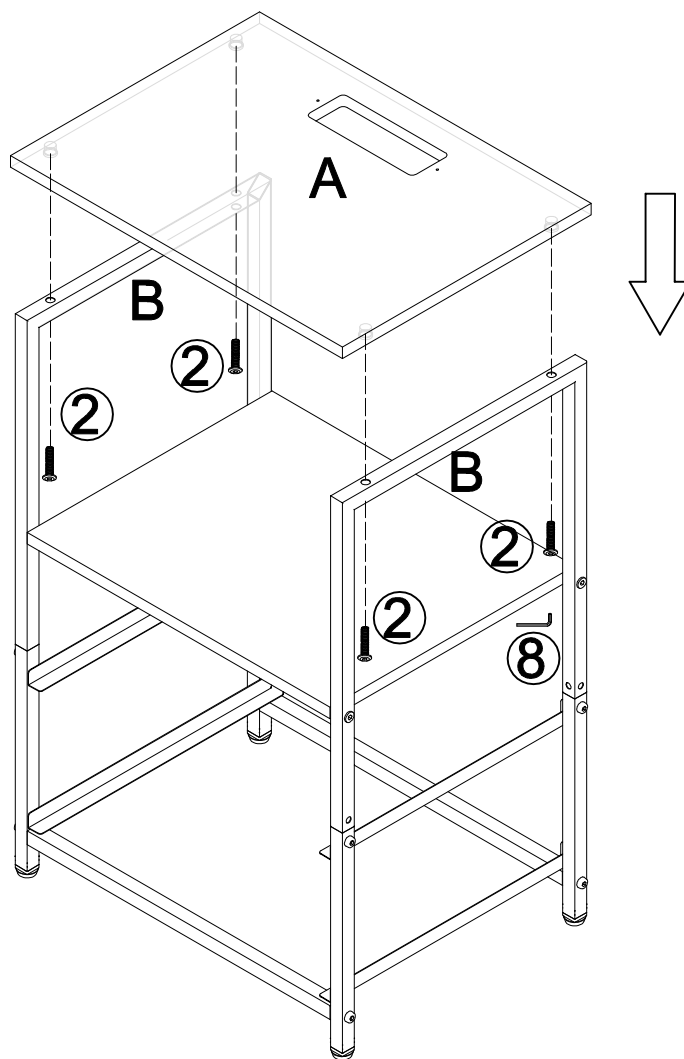

Step 4

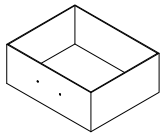

G x 2

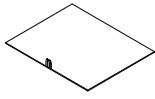

H x 2



3 x 2



7 x 4

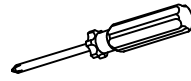

x 1

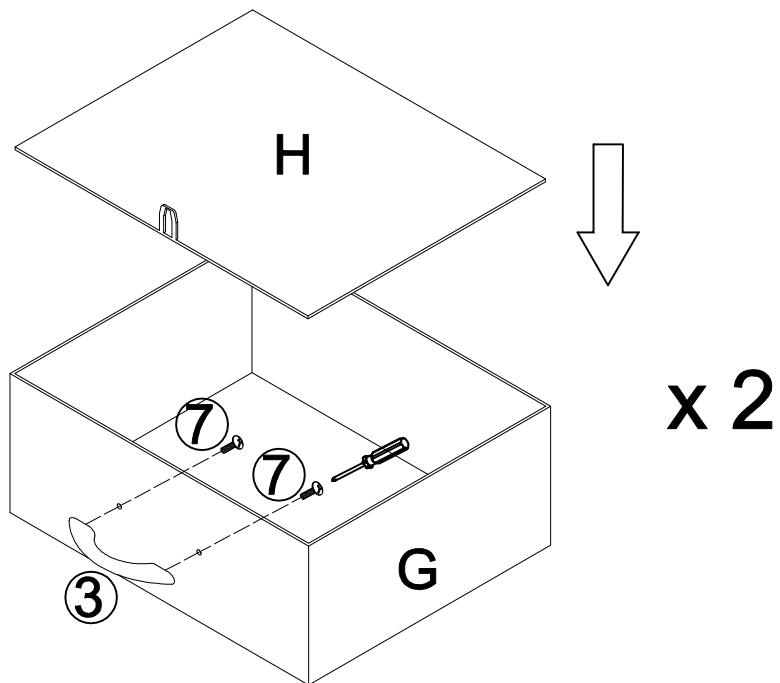

Step 5

