

# ASSEMBLY INSTRUCTIONS

ITEM NO.WF315636

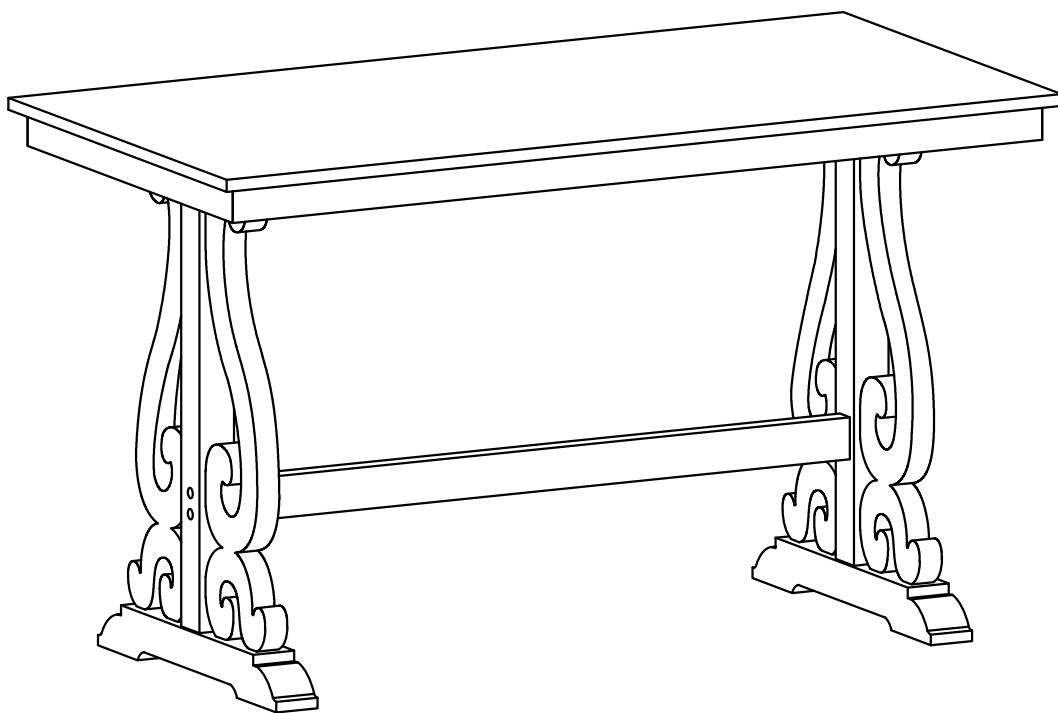

## IMPORTANT NOTE :

- ① PLACE ALL PARTS ON A CLEAN AND SMOOTH SURFACE SUCH AS A RUG OR CARPET TO AVOID THE PARTS FROM BEING SCRATCHED.
- ② BEFORE YOU BEGIN,KINDLY FOLLOW THE ASSEMBLY INSTRUCTIONS STEP BY STEP.
- ③ DO NOT TIGHTEN ALL SCREWS AND BOLTS UNTIL THE TABLE IS FULLY SET-UP.

A

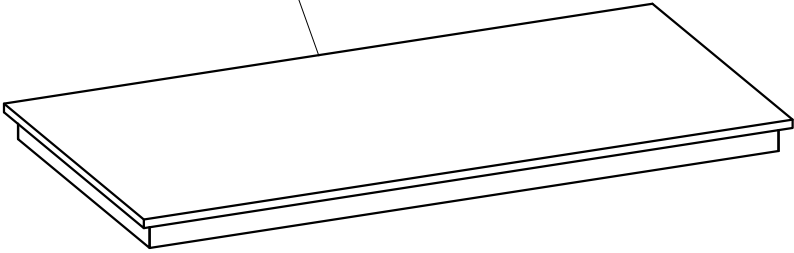

B

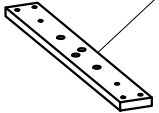

D



C



F

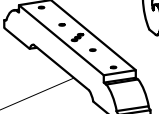

C

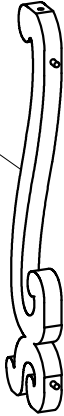

B

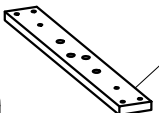

C



E

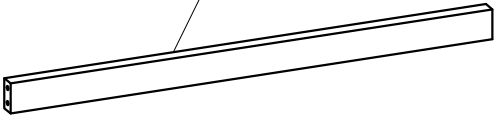

C



D





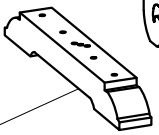



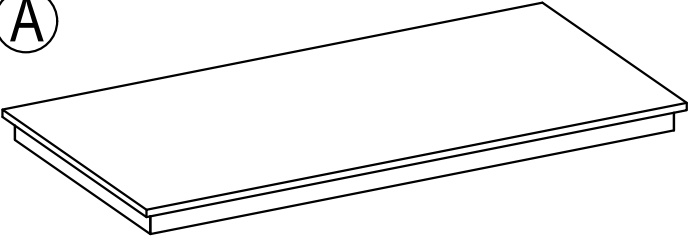
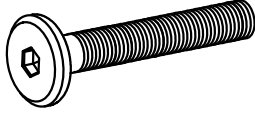
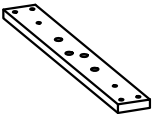

F

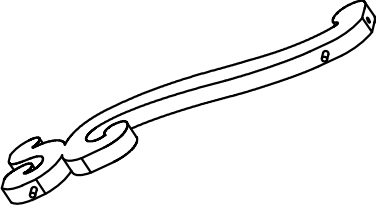

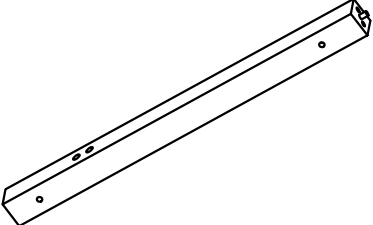
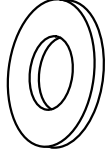
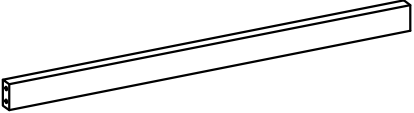
# Part List

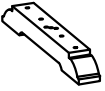
# Hardware List

<p>(A)</p> 	<p>(1)</p>  <p>Ø 5/16" x 35 mm</p>
<p>TABLE TOP(1 pc)</p>	<p>BOLT (20 pcs)</p>
<p>(B)</p> 	<p>(2)</p>  <p>Ø 5/16" x 60 mm</p>
<p>PANEL TOP LEG (2pcs)</p>	<p>BOLT (12 pcs)</p>
<p>(C)</p> 	<p>(3)</p>  <p>Ø5/16" x 13 mm</p>
<p>DECORATIVE COTTON (4 pcs)</p>	<p>FLAT WASHER (32 pcs)</p>
<p>(D)</p> 	<p>(4)</p>  <p>Ø5/16" x 19 mm</p>
<p>BETWEEN LEG (2pcs)</p>	<p>LOCK WASHER (12 pcs)</p>
<p>(E)</p> 	<p>(5)</p>  <p>4 mm</p>
<p>BETWEEN STRETCHER (1 pc)</p>	<p>ALLEN KEY (1 pc)</p>
<p>(F)</p> 	<p>(6)</p> 
<p>BOTTOM STRETCHER (2pcs)</p>	<p>WOOD PLUG (4pcs)</p>

# STEP 1:

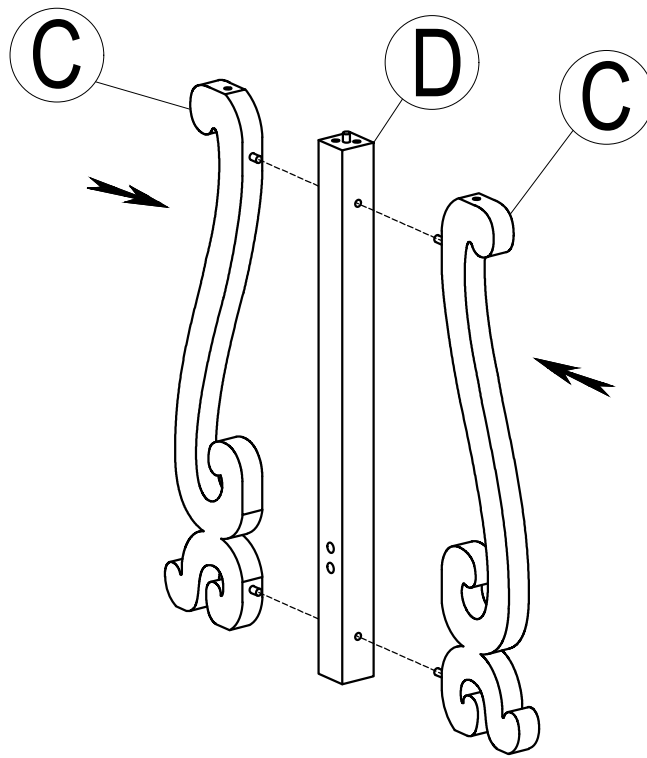

# STEP 2:

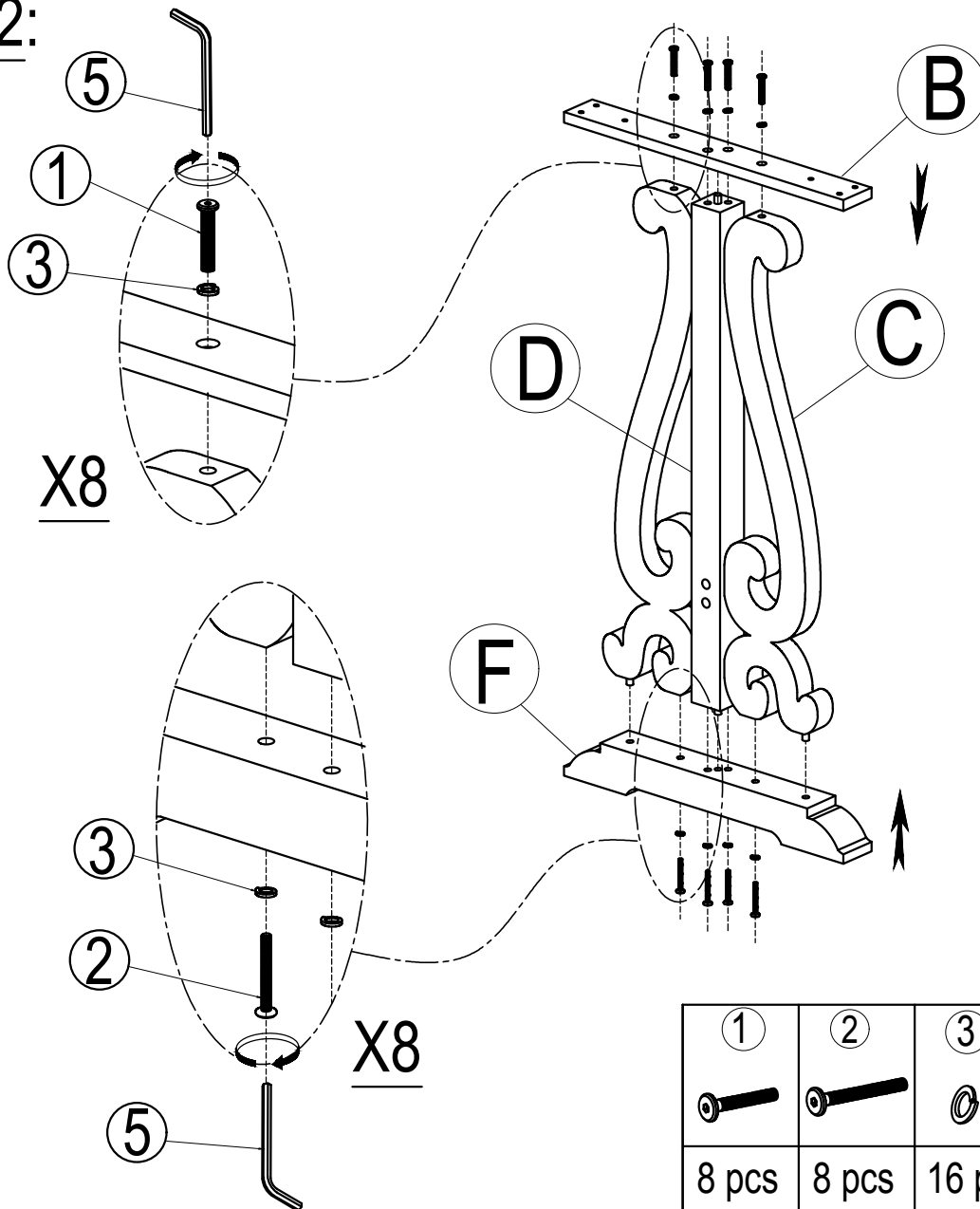

### STEP 3:

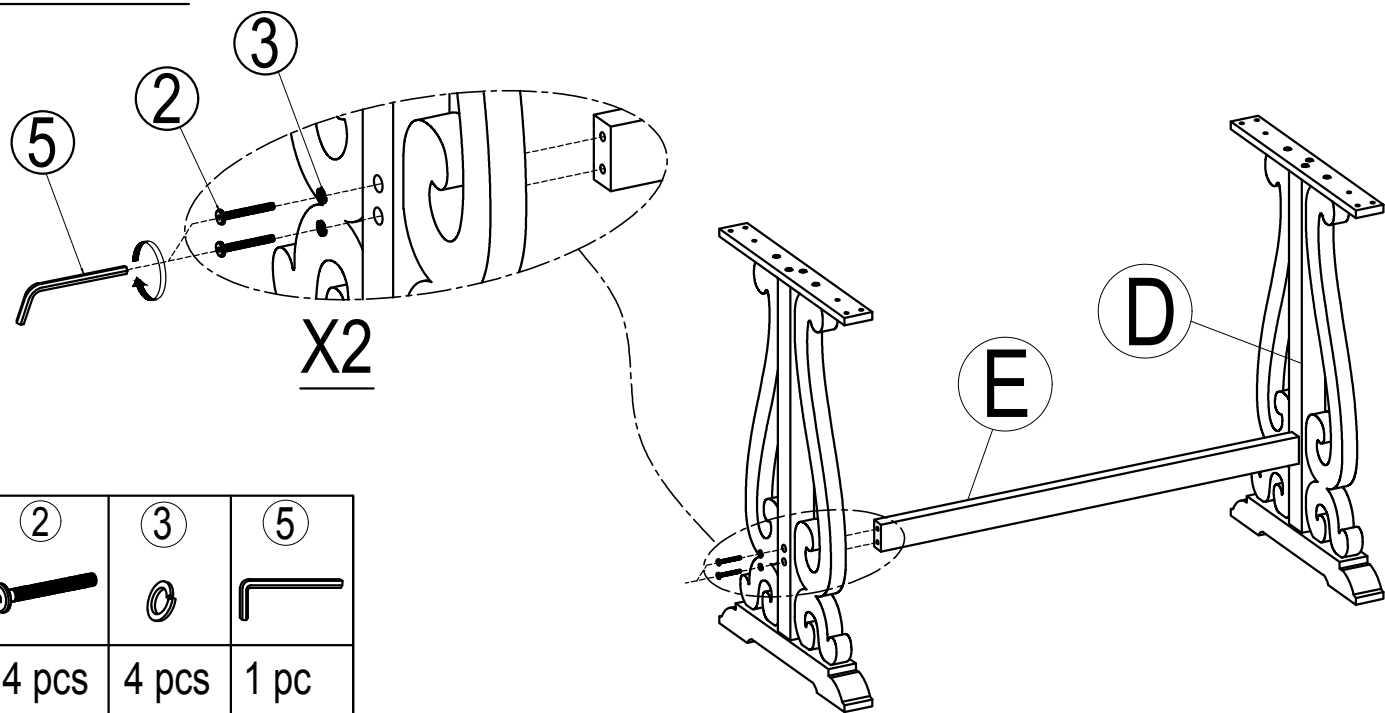

②	③	⑤
4 pcs	4 pcs	1 pc

### STEP 4:

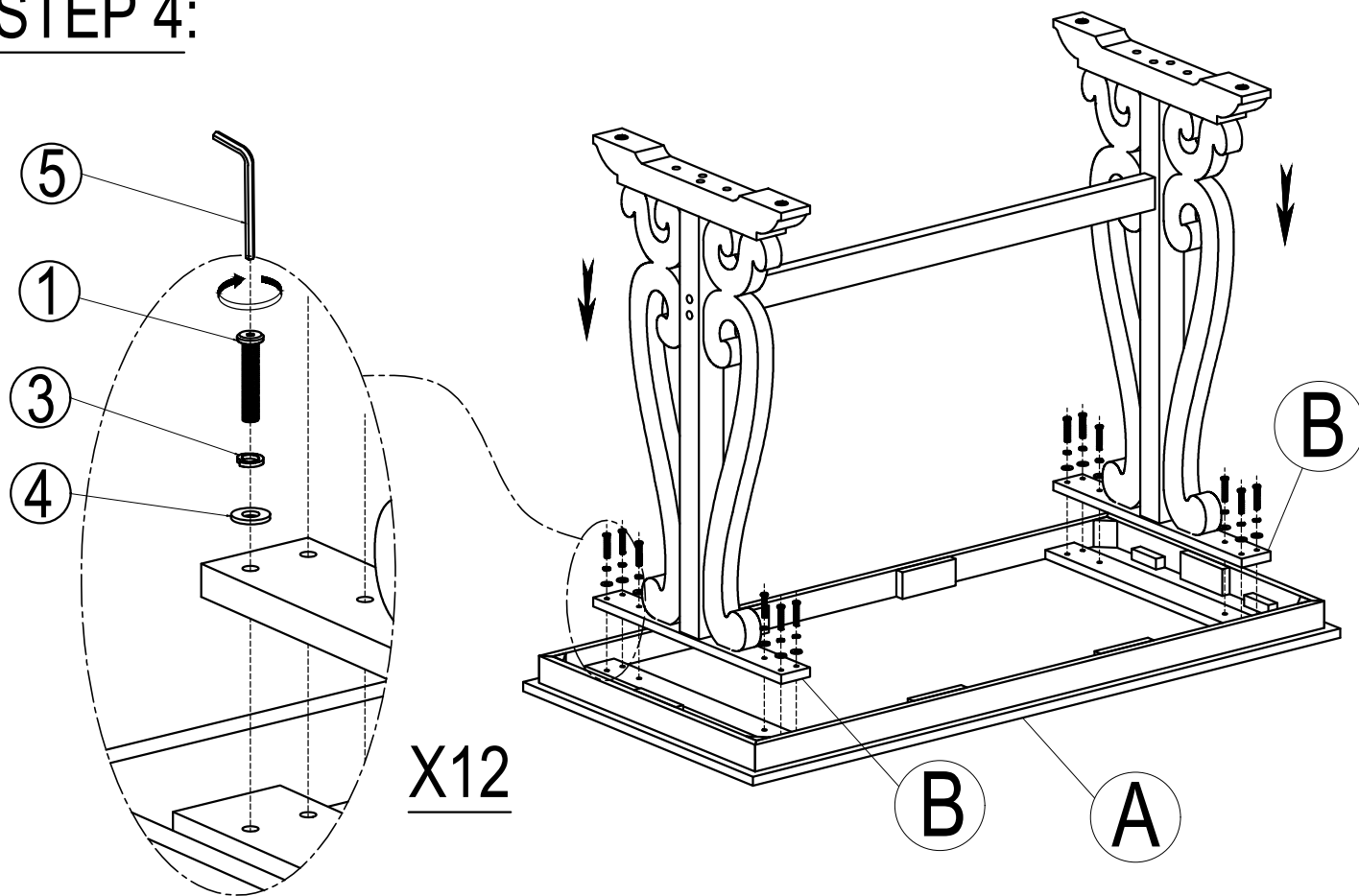

①	③	④	⑤
12 pcs	12 pcs	12 pcs	1 pc

STEP 5:

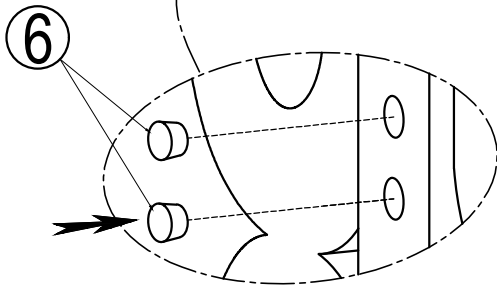
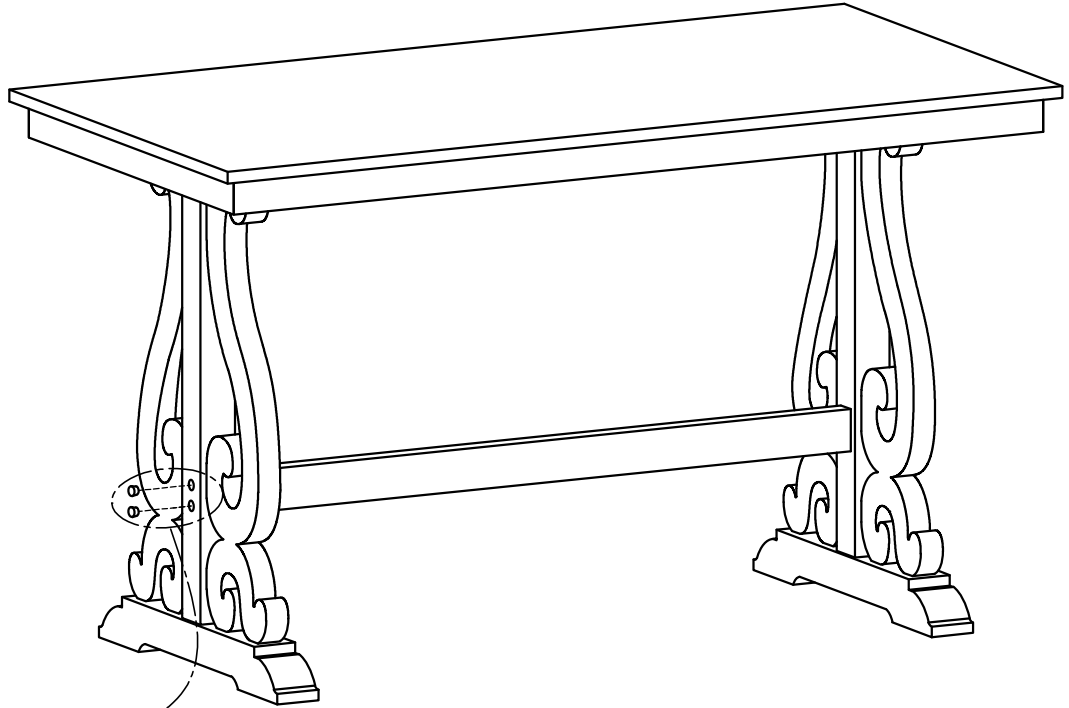

X2

⑥

4 pcs