

Assembly Instructions

ITEM NO. WF 314995

CONSOLE TABLE

Thank you for purchasing this quality product. Be sure to check all packing materials carefully for small parts, which may have come loose inside the carton during shipment. Identify and count all items and compare with the PARTS LIST and/or HARDWARE LIST shown below.



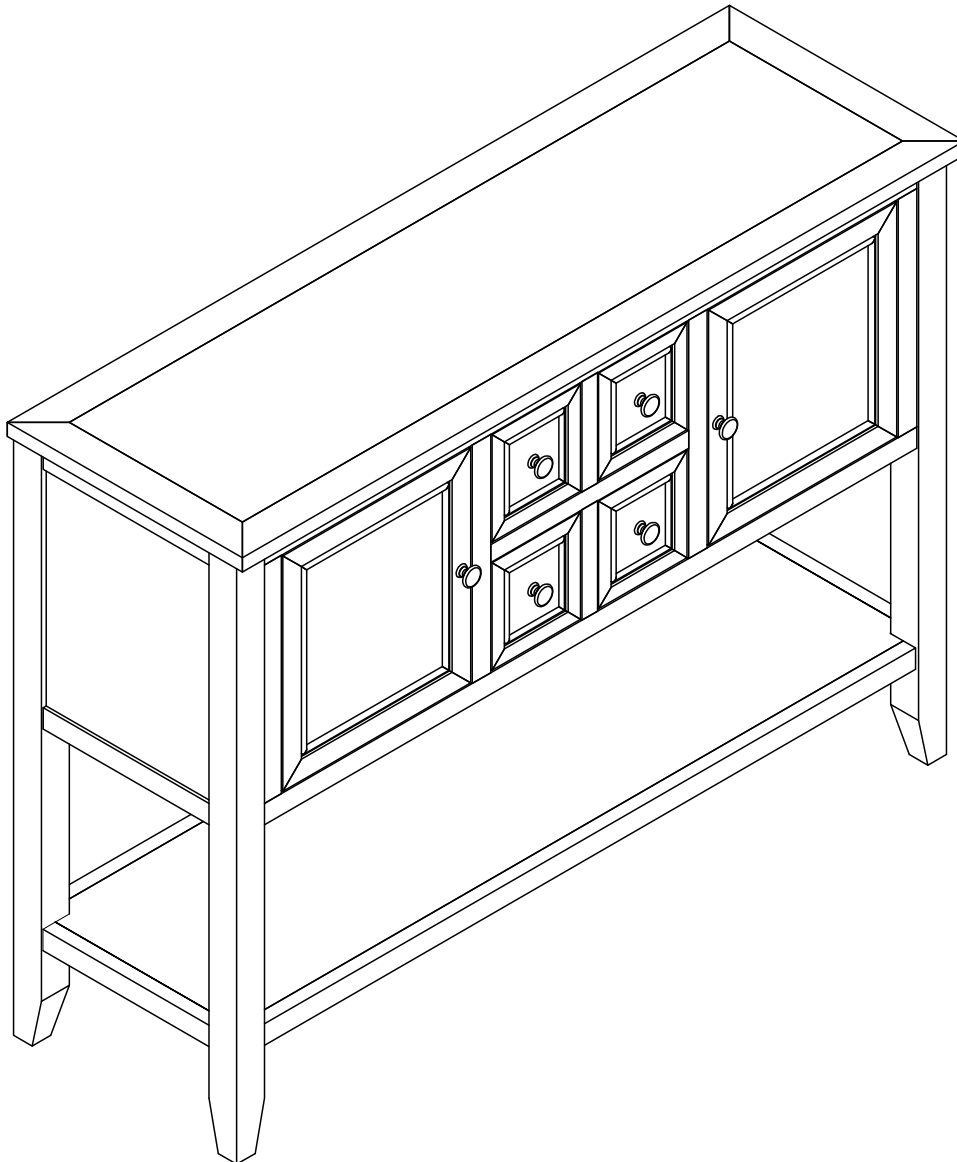

Caution: Please read the instructions thoroughly before assembly.

1. We recommend that you assemble this product with the assistance of another person; this will make the assembly easier, and will help eliminate damage to the product or injury to persons during assembly.
2. Please do not over tighten screws or bolts until the assembly is completed.
3. Please put all parts on a non-abrasive floor before assembly, and follow the assembly steps to assemble your newly purchased product correctly and efficiently.

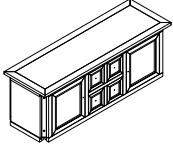

Assembly Instructions

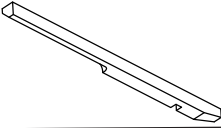
ITEM NO. WF 314995
CONSOLE TABLE

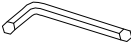
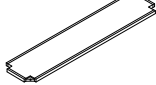
PART LISTS				HARDWARE LIST			
NO	DESCRIPTION	SKETCH	Q'TY	NO	DESCRIPTION	SKETCH	Q'TY
A	Table Frame		1 PC	1	Bolt 5/16" x 50mm		12 PCS
				2	Spring Washer 5/16"		12 PCS
B	Legs		4 PCS	3	Washer 5/16"		12 PCS
				4	Allen Key L=110		1 PC
C	Shelf		1 PC				

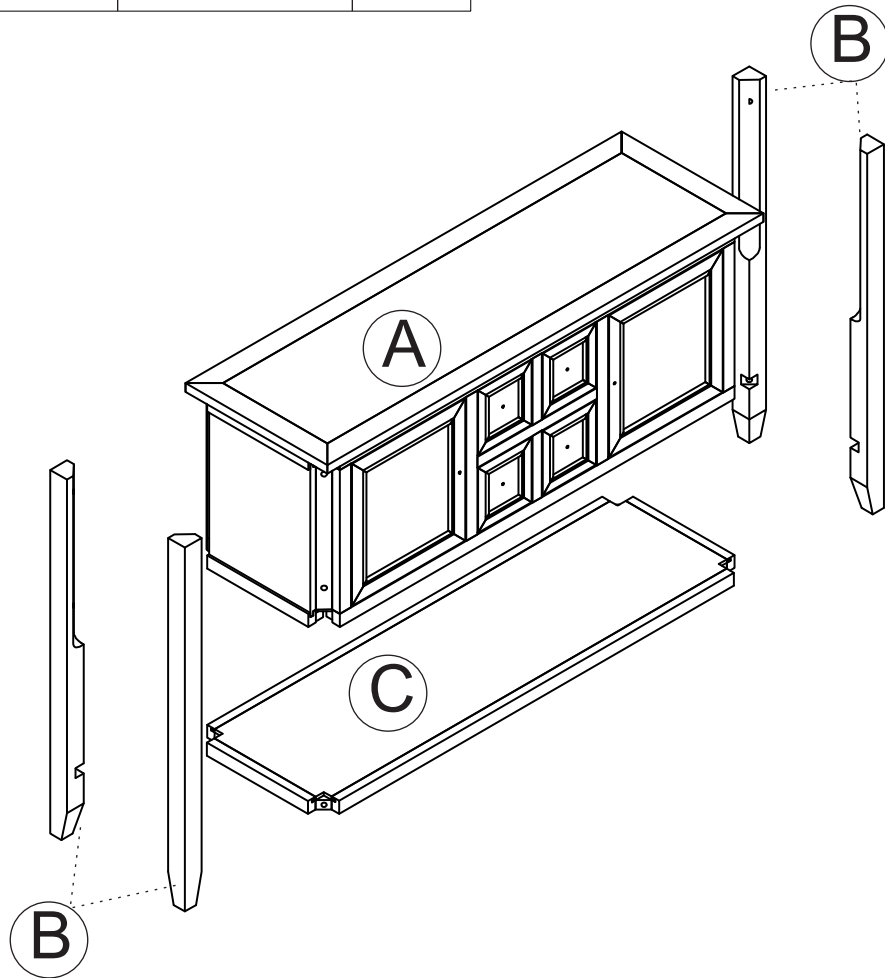

Assembly Instructions

ITEM NO. WF 314995
CONSOLE TABLE

STEP 1

Do **NOT** overtighten hardware.
Tighten only 50% for now.

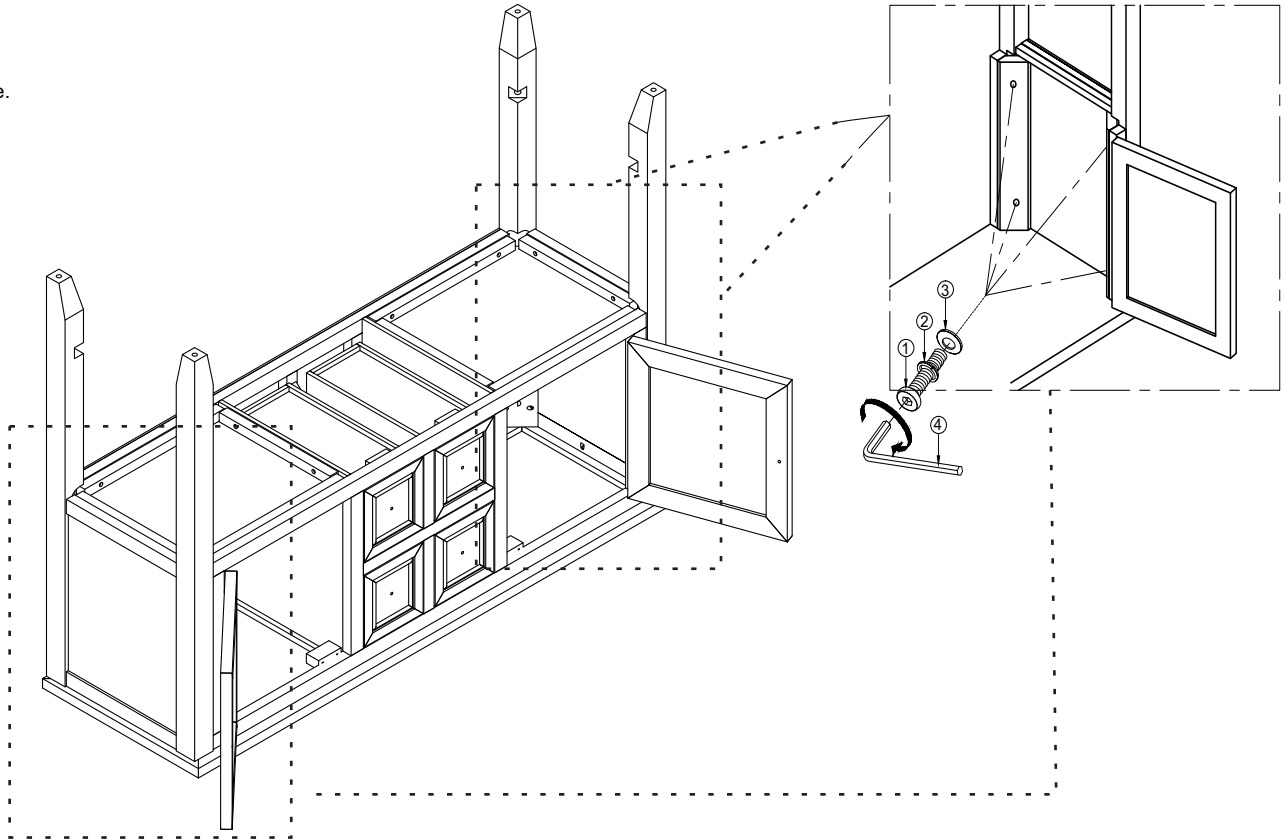

1 x8 2 x8 3 x8 4 x1

STEP 2

Do **NOT** overtighten hardware.
Tighten only 75% for now.

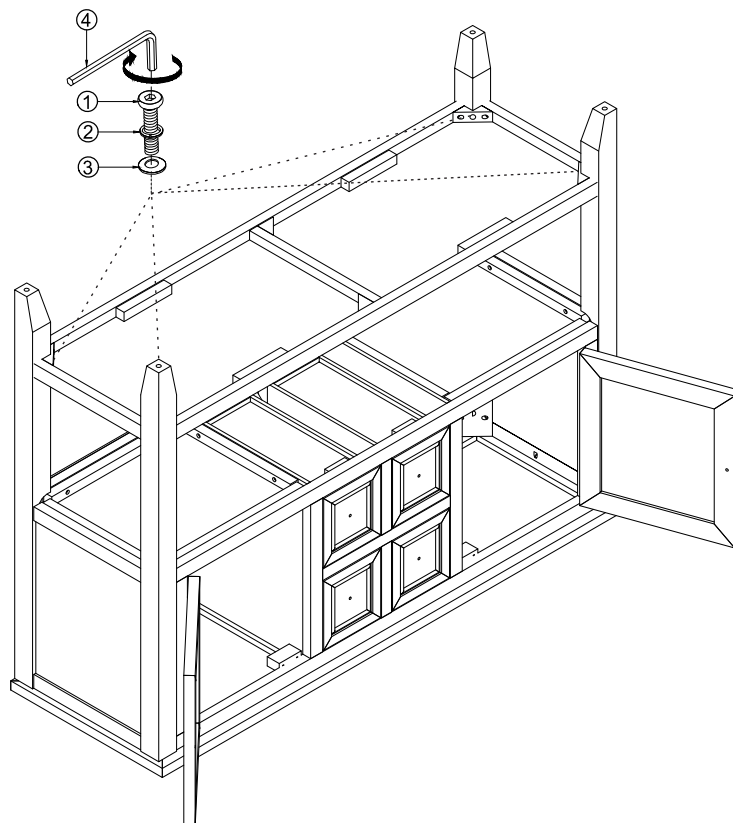

1 x4 2 x4 3 x4 4 x1

Assembly Instructions

ITEM NO. WF 314995
CONSOLE TABLE

STEP 3

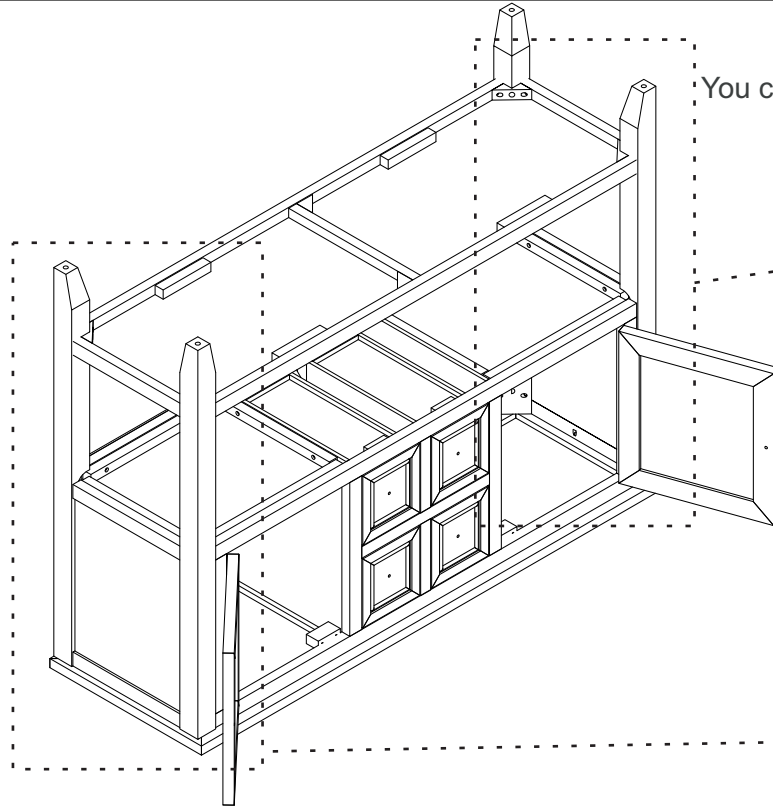

You can tighten 100% all Bolt this step

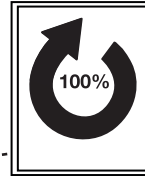

STEP 4

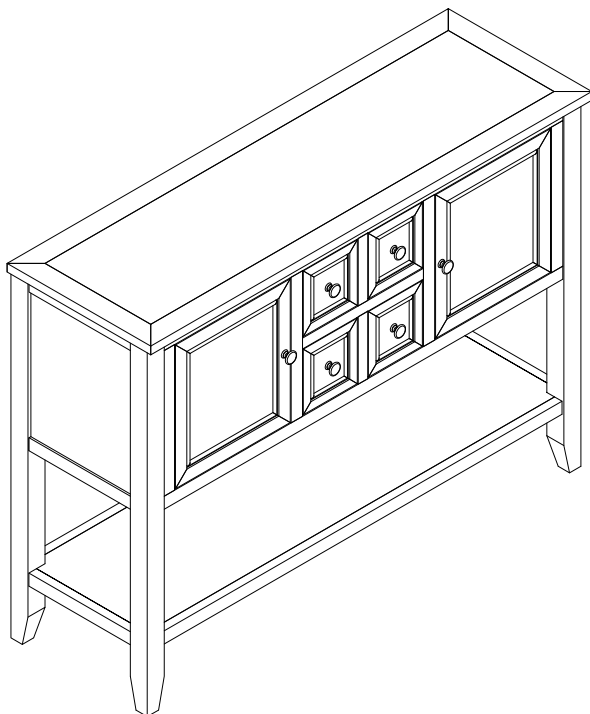

Remove the Handle in
side drawer and mount out
side when in use (on 4
Drawers and 2 Doors)

