

ASSEMBLY INSTRUCTIONS

DINING CHAIR

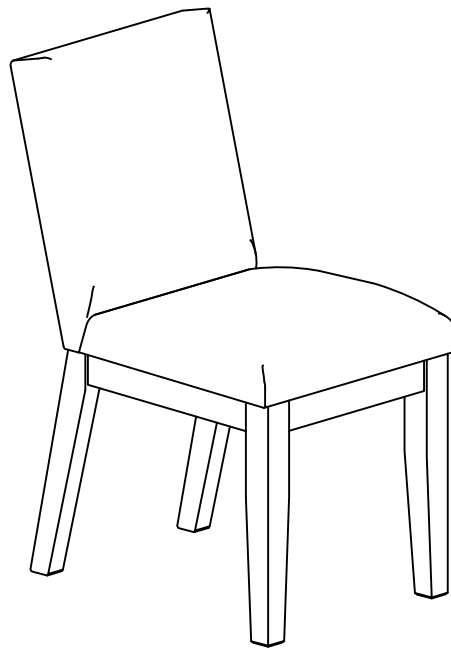



WF309287

IMPORTANT NOTE:

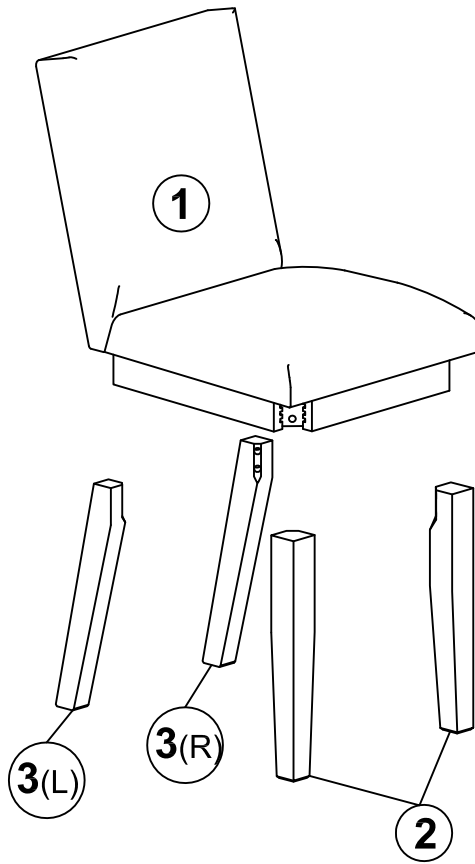

- ① PLACE ALL PARTS ON A CLEAN AND SMOOTH SURFACE SUCH AS A RUG OR CARPET TO AVOID THE PARTS FROM BEING SCRATCHED.
- ② BEFORE YOU BEGIN, KINDLY FOLLOW THE ASSEMBLY INSTRUCTIONS STEP BY STEP.
- ③ DO NOT TIGHTEN ALL SCREWS AND BOLTS UNTIL THE CHAIR IS FULLY SET-UP.

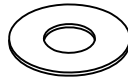

Hardware List For One Chair



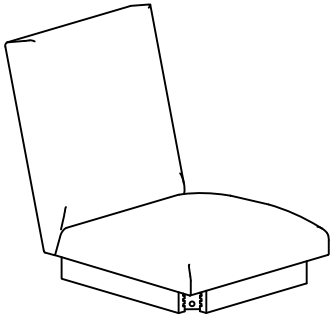

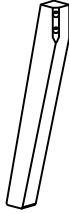
<p>A</p>  <p>Ø1/4"x 60mm</p>	<p>C</p>  <p>Ø1/4"x 19mm</p>
<p>BOLT (8pcs)</p>	<p>FLAT WASHER (8pcs)</p>
<p>B</p>  <p>Ø1/4"x 11mm</p>	<p>D</p>  <p>4mm</p>
<p>LOCK WASHER (8pcs)</p>	<p>ALLEN KEY (1pc)</p>

Part List For One Chair

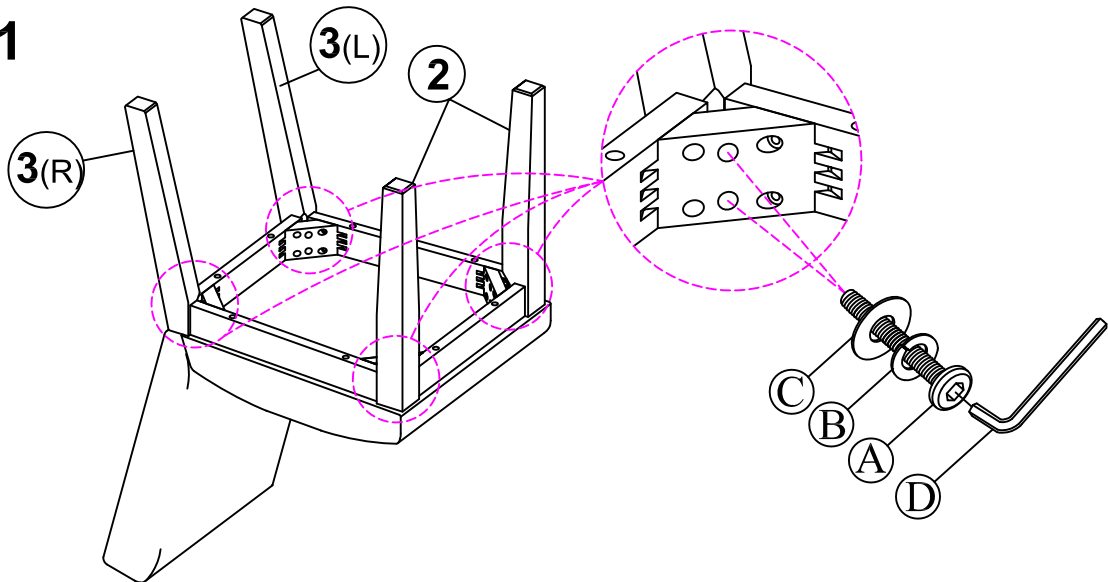
<p>①</p> 	<p>②</p> 	<p>③</p> 
<p>Backrest and Seat Cushion with Frame (1pc)</p>	<p>Front Leg (2pcs)</p>	<p>Back Leg-L/R (2pcs)</p>

Step 1



A	Ø1/4"x 60mm		8pcs	C	Ø1/4"x19mm		8pcs
B	Ø1/4"x11mm		8pcs	D	4mm		1pc

Step 2

