

ASSEMBLY INSTRUCTIONS

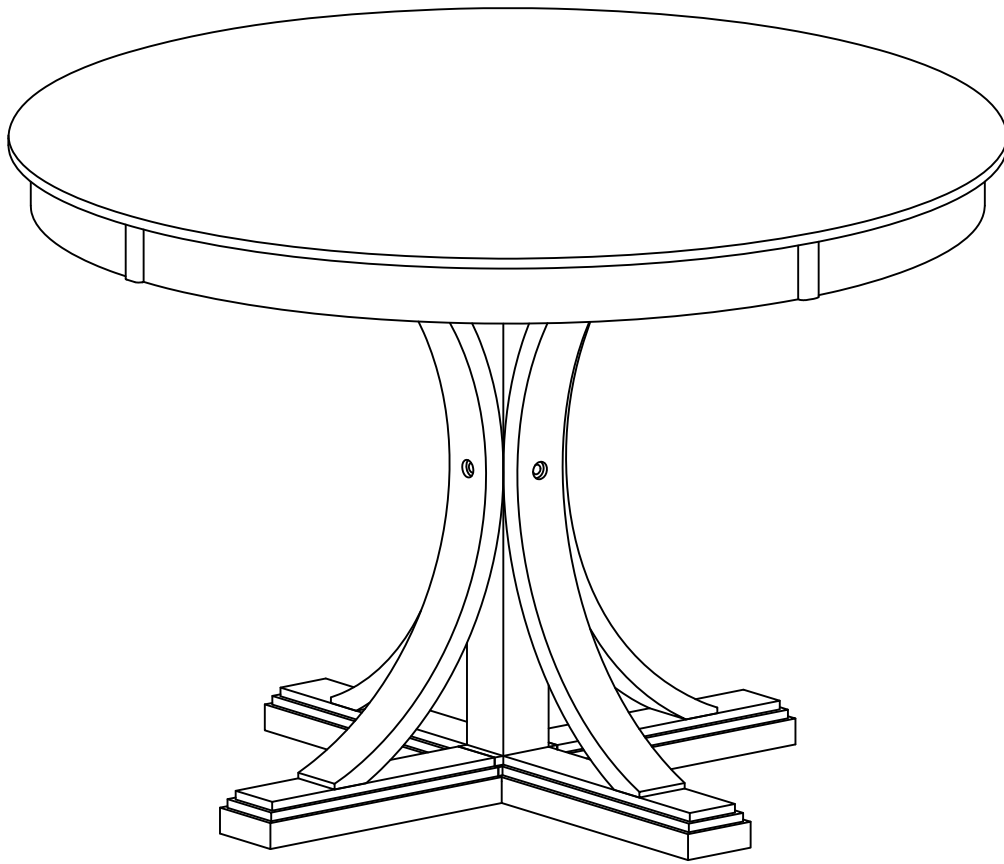







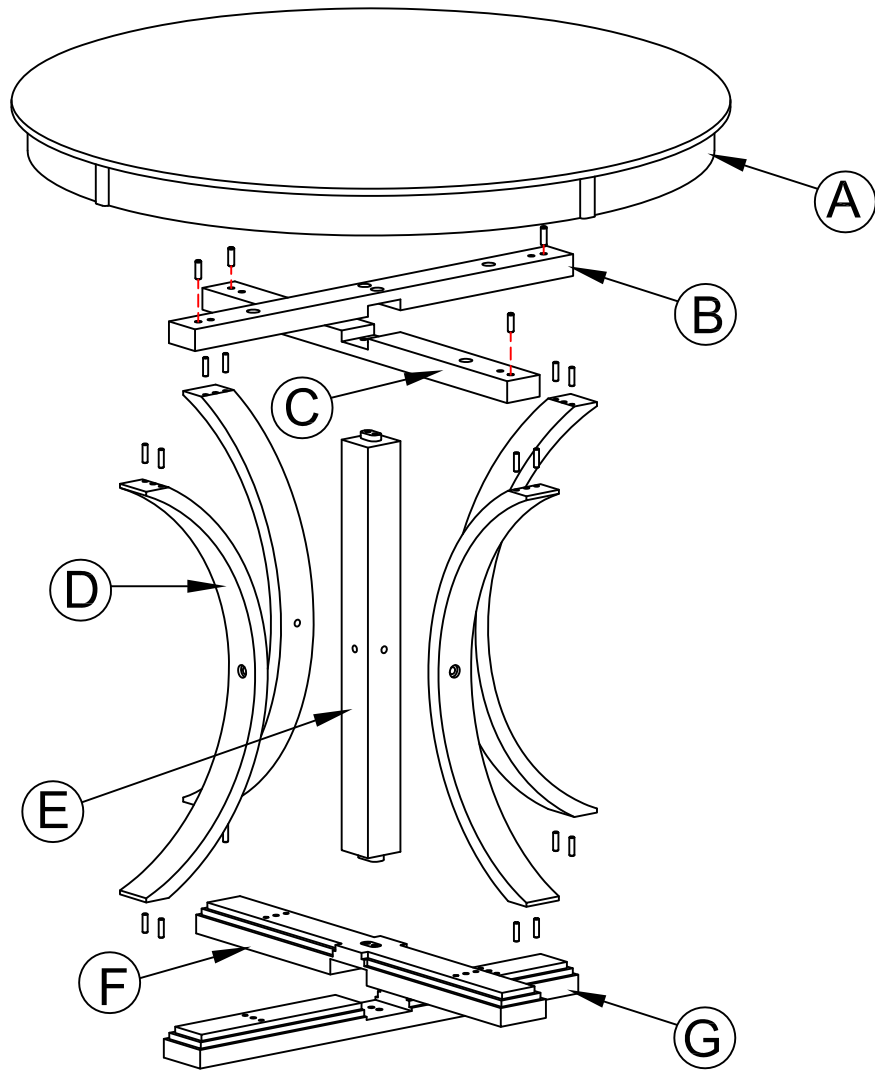

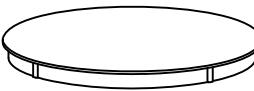
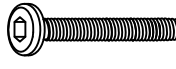

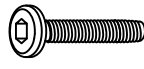
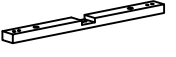
**ITEM NOTE: WF301576
ROUND TABLE**



IMPORTANT NOTE :

- 1 PLACE ALL PARTS ON A CLEAN AND SMOOTH SURFACE SUCH AS A RUG OR CAPET TO AVOID THE PARTS FORM BEING SCARTCHED .
- 2 BEFORE YOU BEGIN , KINDLY FOLLOW THE ASSEMBLY INSTRUCTIONS STEP BY STEP
- 3 DO NOT TIGHTEN ALL SCREWS AND BOLTS UNTILL THE TABLE FULLY SET-UP

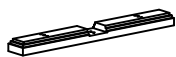

Part List For One			Hardware List For One		
No.	Hardware Description	Q'ty	No.	Hardware Description	Q'ty
A	 Table top	1pc	1	 Bolt Ø1/4" x 50mm	8pcs
B	 Supporting bar	1pc	2	 Bolt Ø1/4" x 30mm	12pcs
C	 Supporting bar	1pc	3	 Lock washer Ø1/4" x11x1.5mm	20pcs
D	 Support Arc	4pcs	4	 Flat washer Ø1/4" x16 x1.5mm	20pcs
E	 Support center	1pc	5	 Allen key 4 x 60 mm	1pc
F	 Cross Leg	1pc	6	 Dowel Ø8 x 30 mm	16pcs
G	 Cross Leg	1pc	7	 Dowel Ø10 x 30 mm	4pcs

Step 1

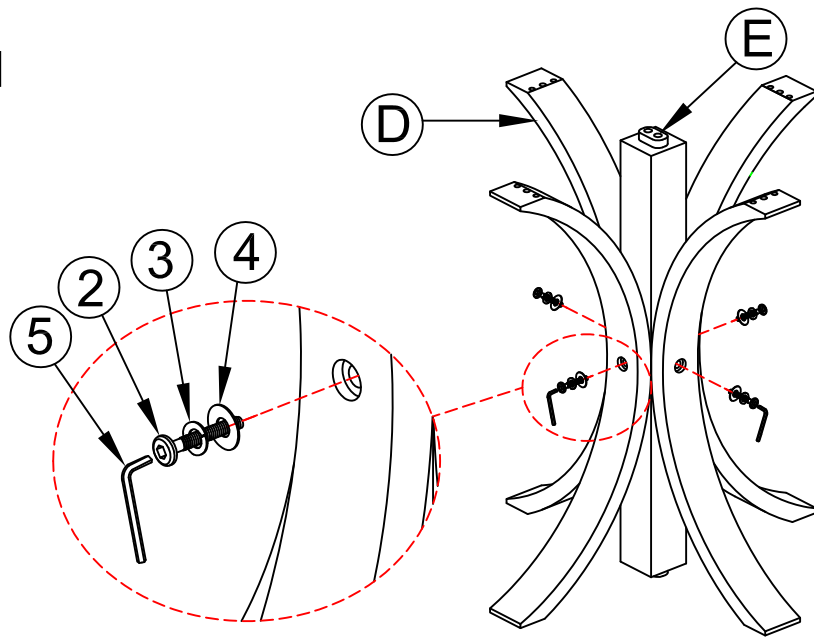

Step 2

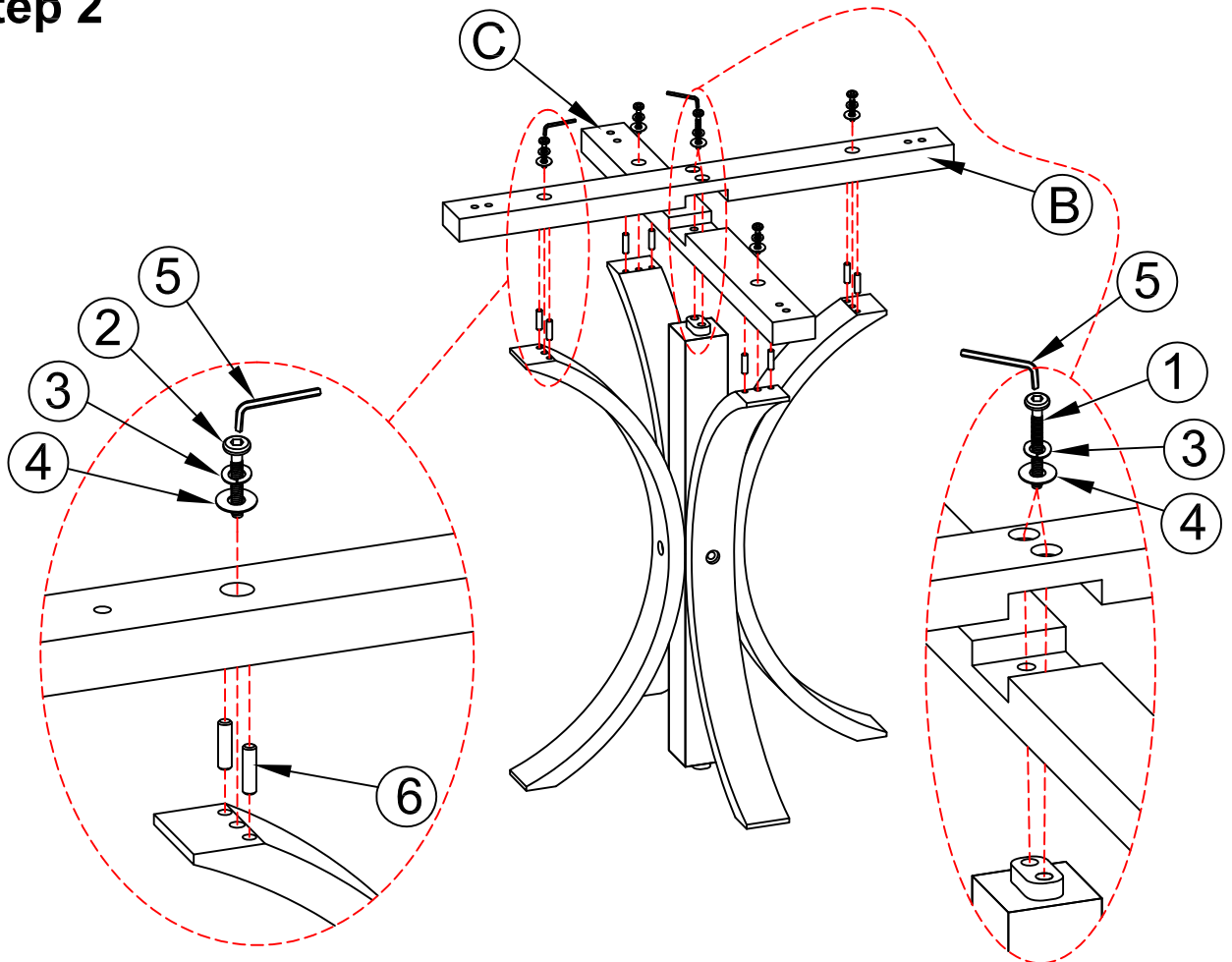

Step 3

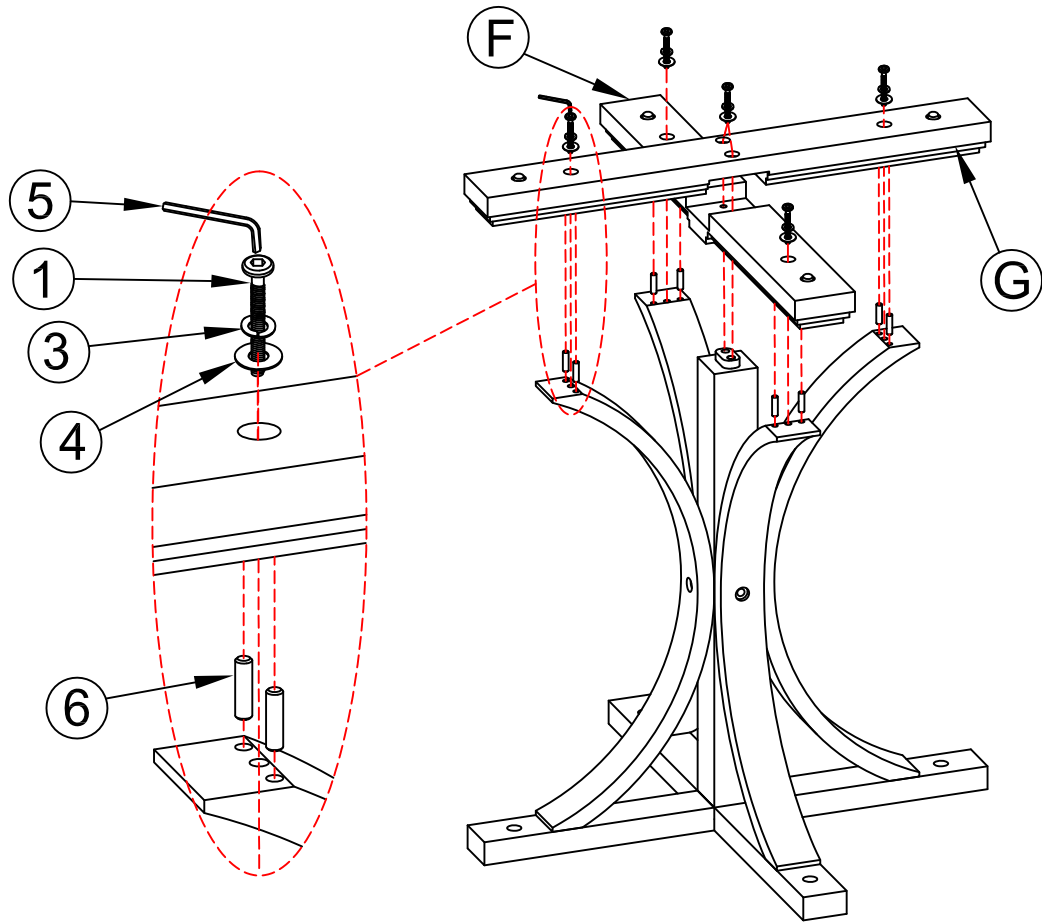

Step 4

