

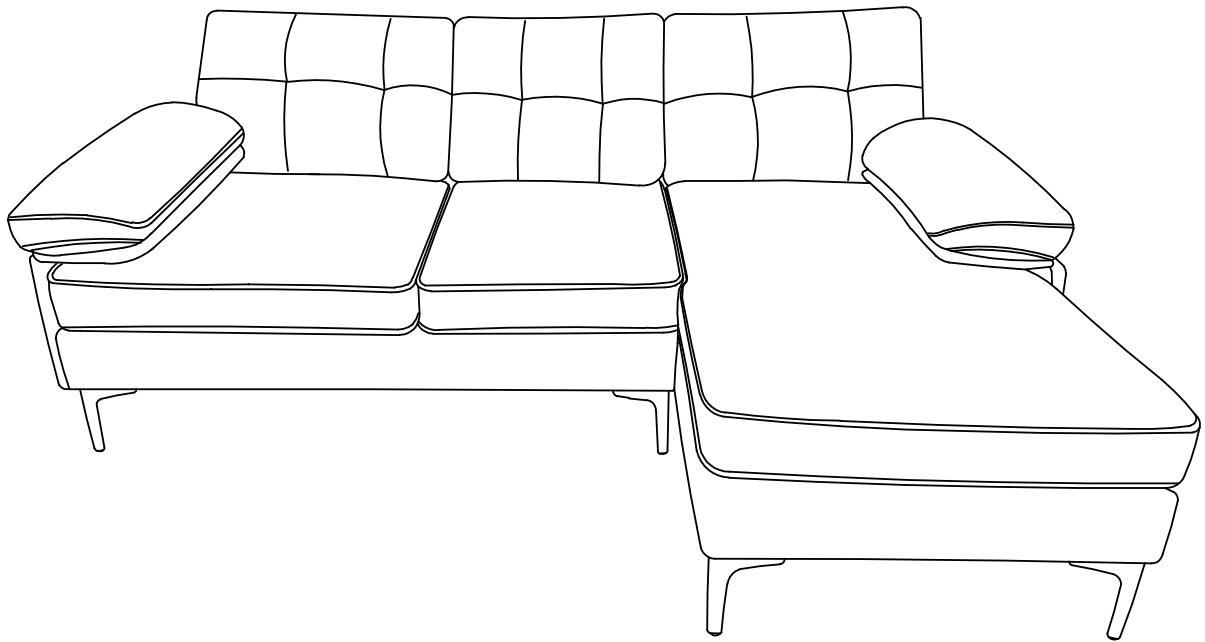

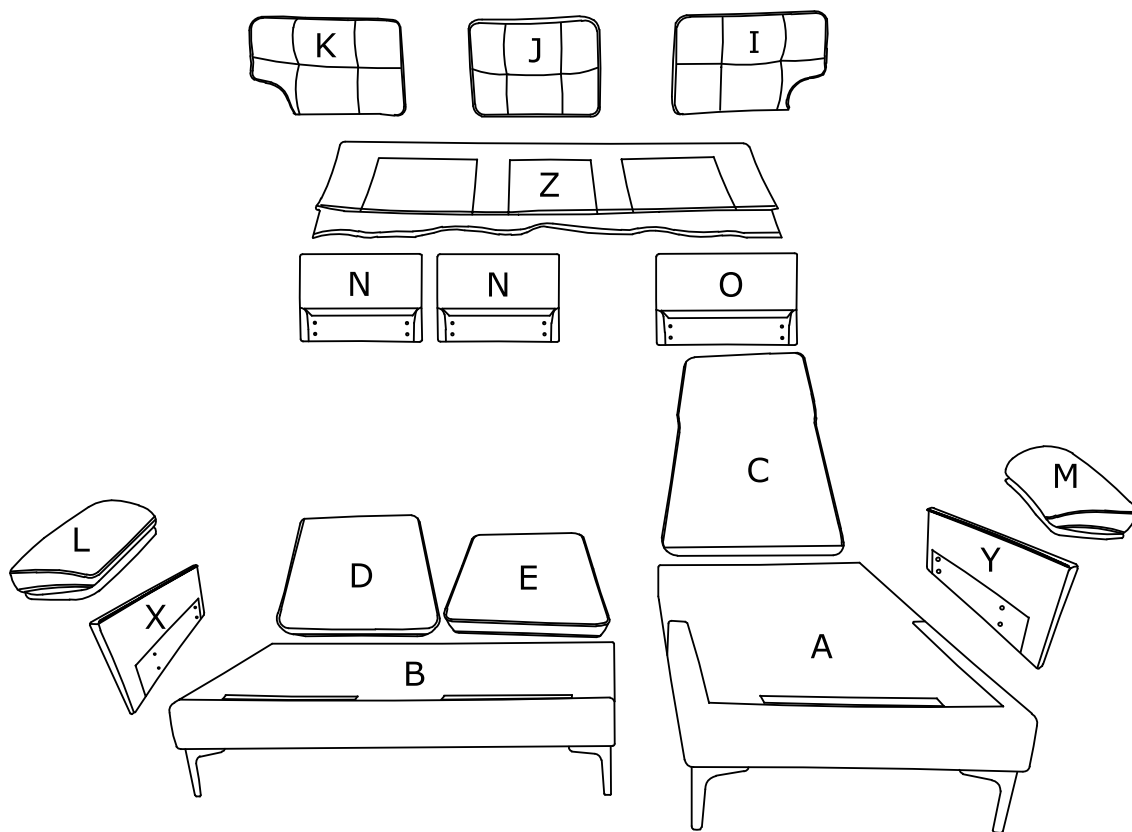





INSTRUCTION MANUAL

L SHAPED SECTIONAL





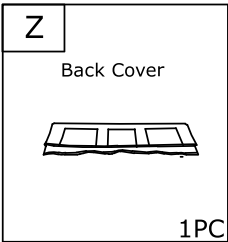
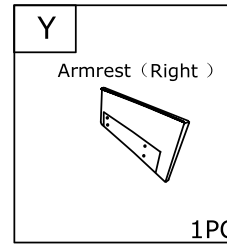
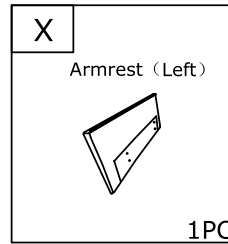
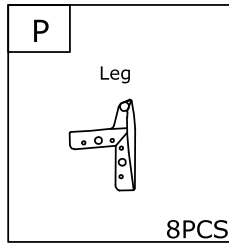
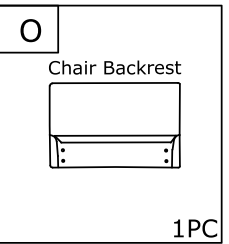
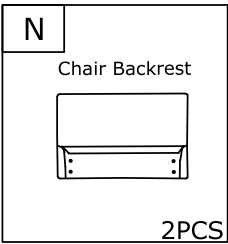
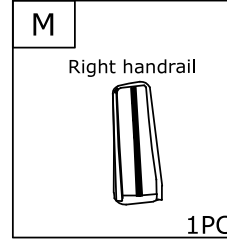
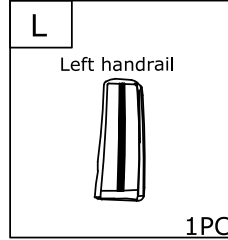
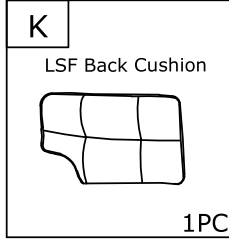
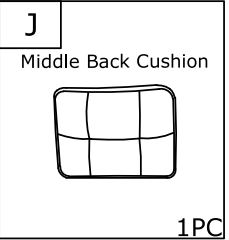
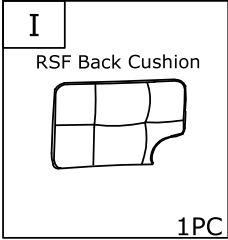
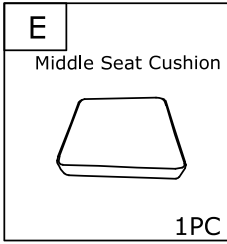
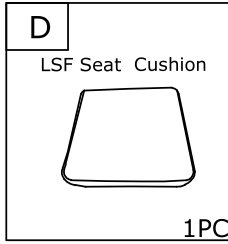
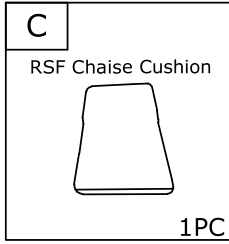
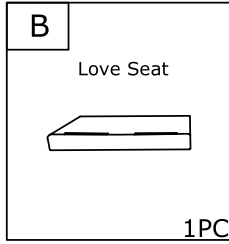
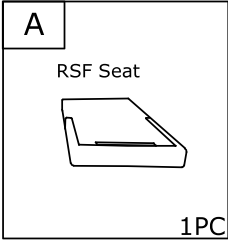

- P  8X Sofa Leg
- Q  16X Bolt 8*18mm
- R  12X Bolt 8*70mm
- S  1X Bolt 8*80mm
- T  8X Bolt 8*80mm
- U  9X Butterfly Nut
- V  22X Flat Washer
- W  1X Allen Key

TOOLS REQUIRED:  SCISSORS (NOT INCLUDED)



STEP 1



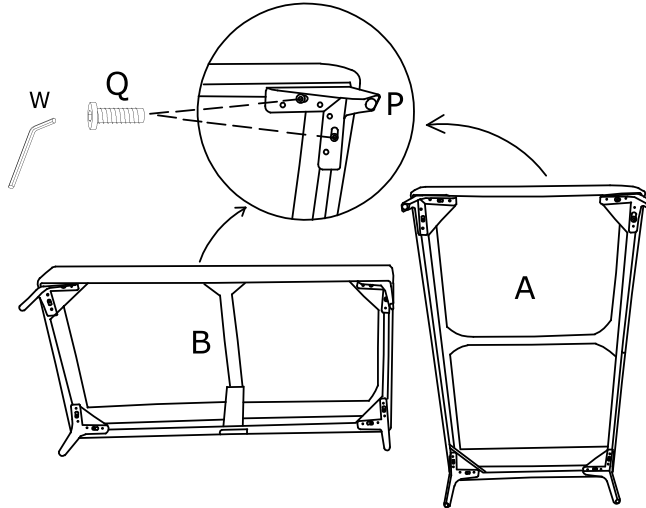

Assemble iron leg (P) with bolts (Q).

Q	 M8x18mm	16PCS
P		8PCS



STEP 2

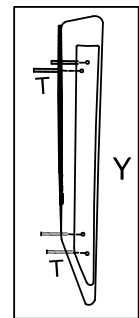
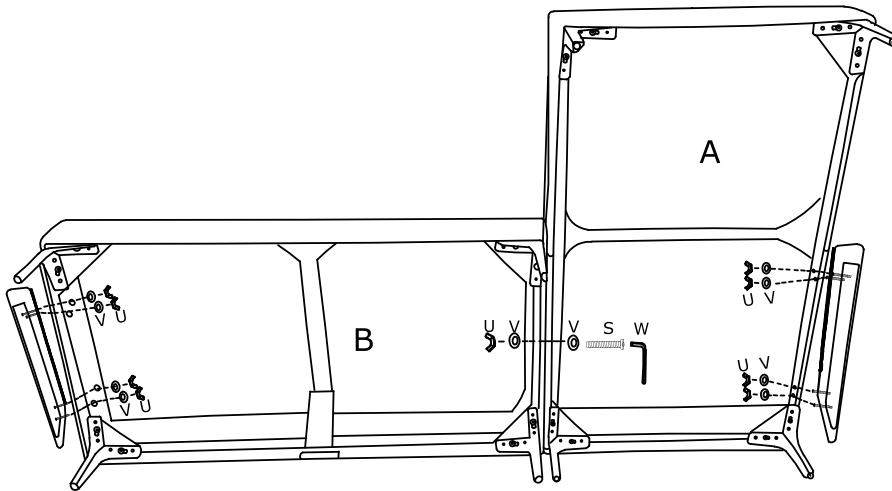
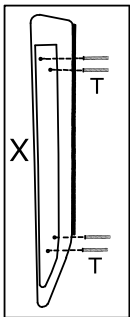

Assembly handrail (X) (Y) with bolts (T) flat Washer (V) butterfly nut (U) assembly, Then assemble the seat frame with screw (S) washers (V) butterfly nuts (U).

S	 M6x80mm	1PC
T	 M6x80mm	8PCS
U		9PCS
V		10PCS



STEP 3

Fixed back frame (N) and (O) with bolts (R) and flat gaskets (V).

R	 M8x70	12PCS
V		12PCS

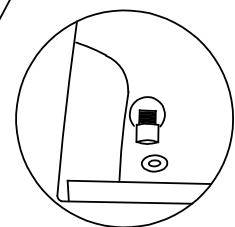
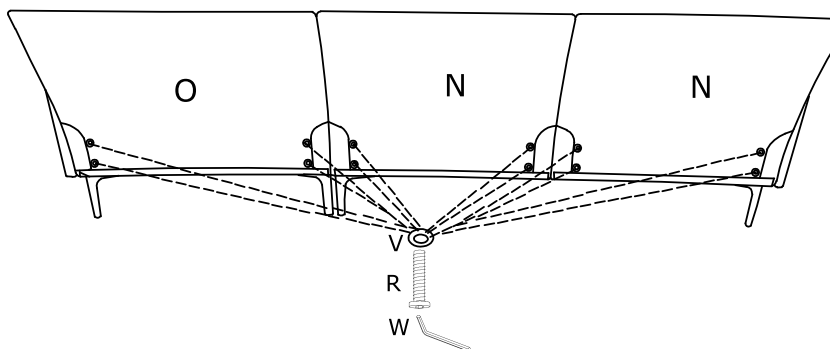

STEP 4

Put the Back Cover on the back frame.

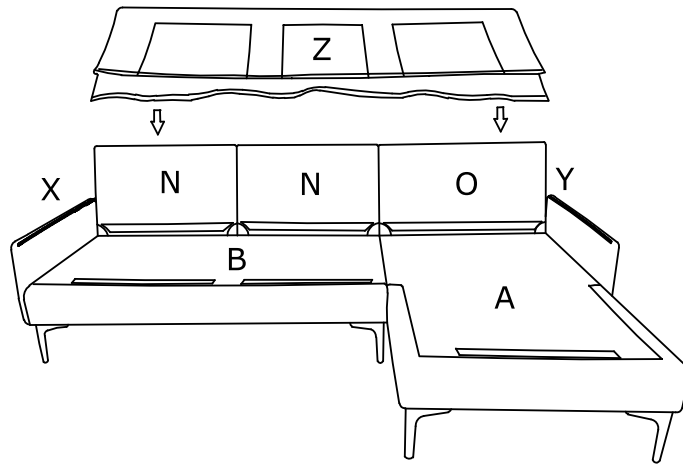

STEP 5

The cushion is packaged by vacuum compression .After cutting the package, it rebounds quickly within 10s.If the fabric has wrinkles,it will basically disappear after standing for 72 hours.

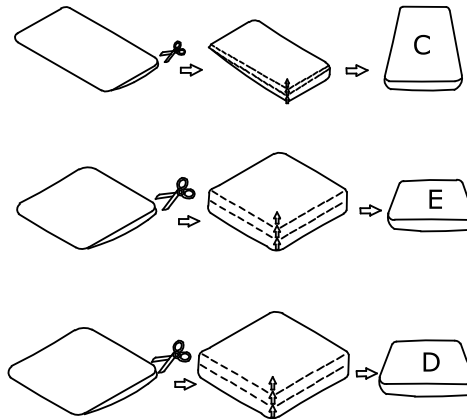

STEP 6

Put the seat cushion on the sofa first, then pull up the left arm(L) Zipper for right handrail (M).

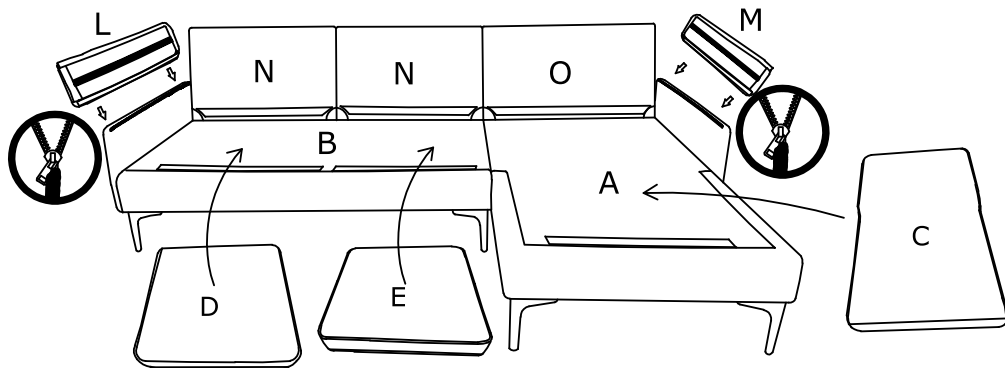

STEP 7

Put the backpack on the sofa.

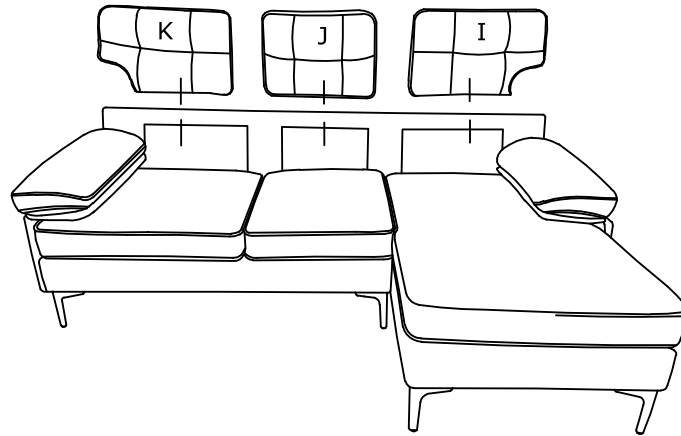

STEP 8

If the fabric has wrinkles, placing 72 hours will basically disappear. Well done! ! You can now enjoy your leisure time on the sofa.

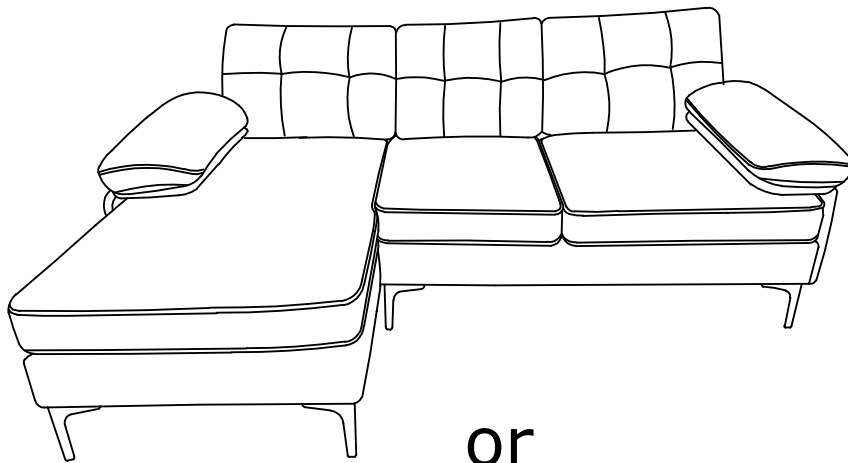

or

