

# ASSEMBLY INSTRUCTION

A 1PCS

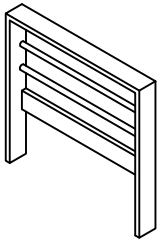

B 1PCS

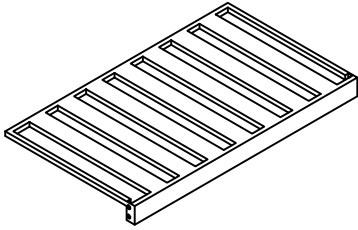

C 1PCS

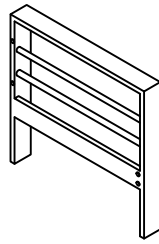

D 1PCS

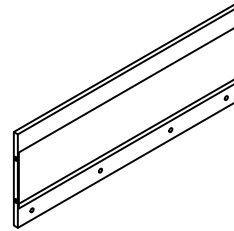

12PCS

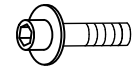

M6X20MM

4PCS



8PCS



M6

1PCS

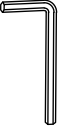

## Step 1

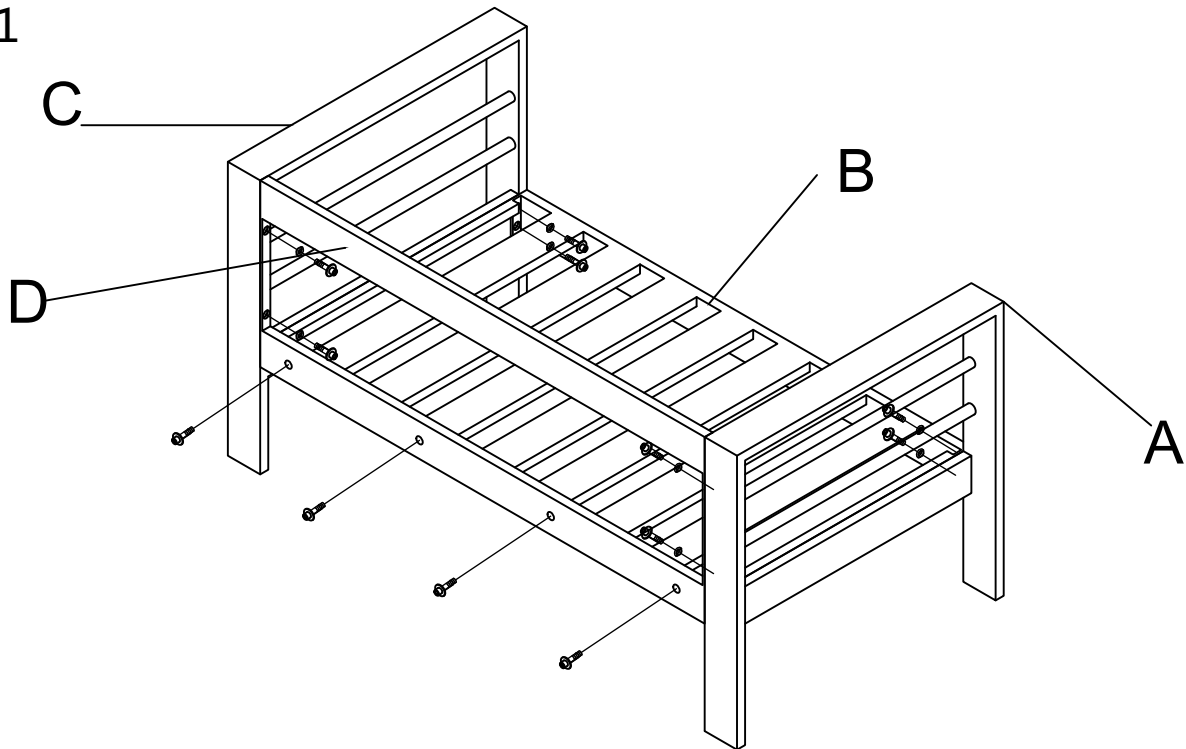

## Step 2

