

ASSEMBLY INSTRUCTION

A 1PCS

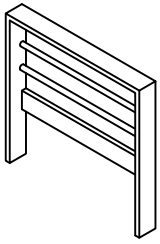

B 1PCS

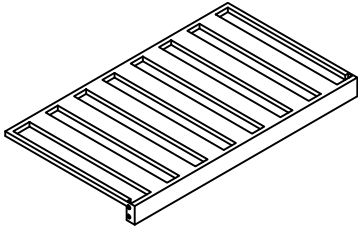

C 1PCS

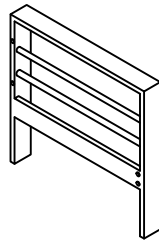

D 1PCS

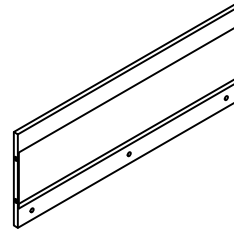

11PCS

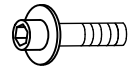

M6X20MM

3PCS



8PCS



M6

1PCS

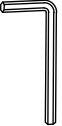

Step 1

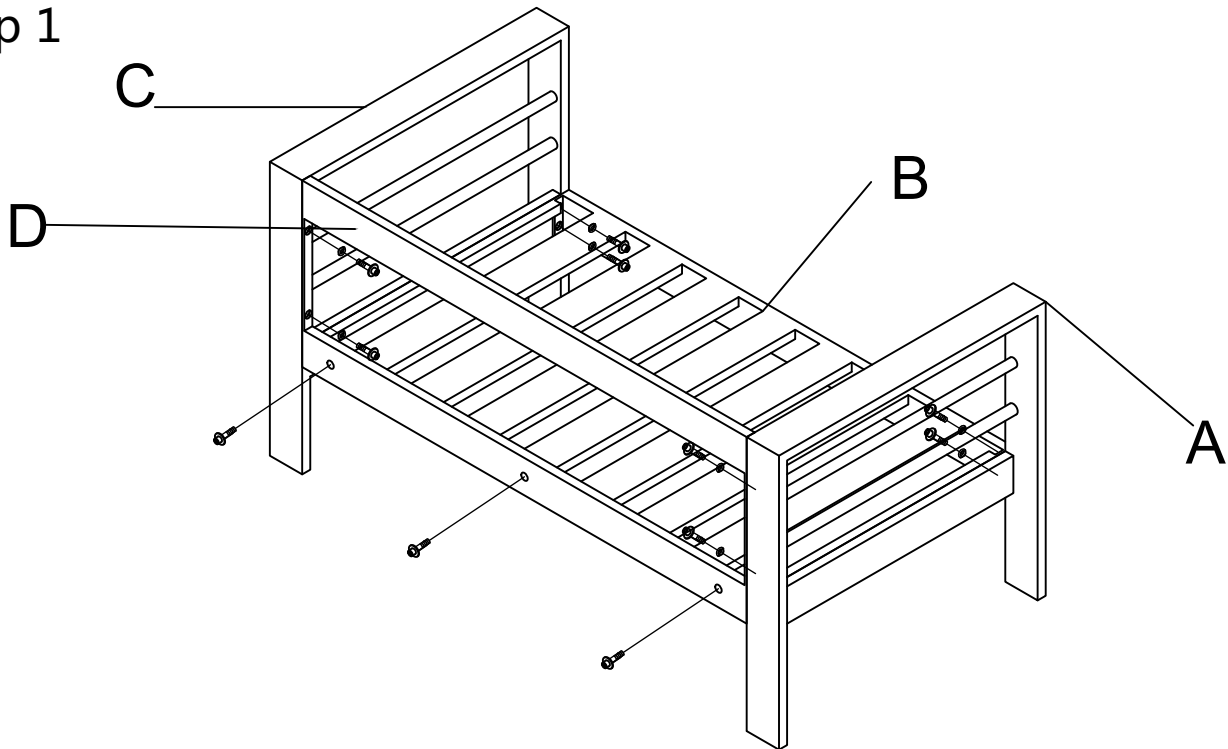

Step 2

