

ASSEMBLY INSTRUCTION

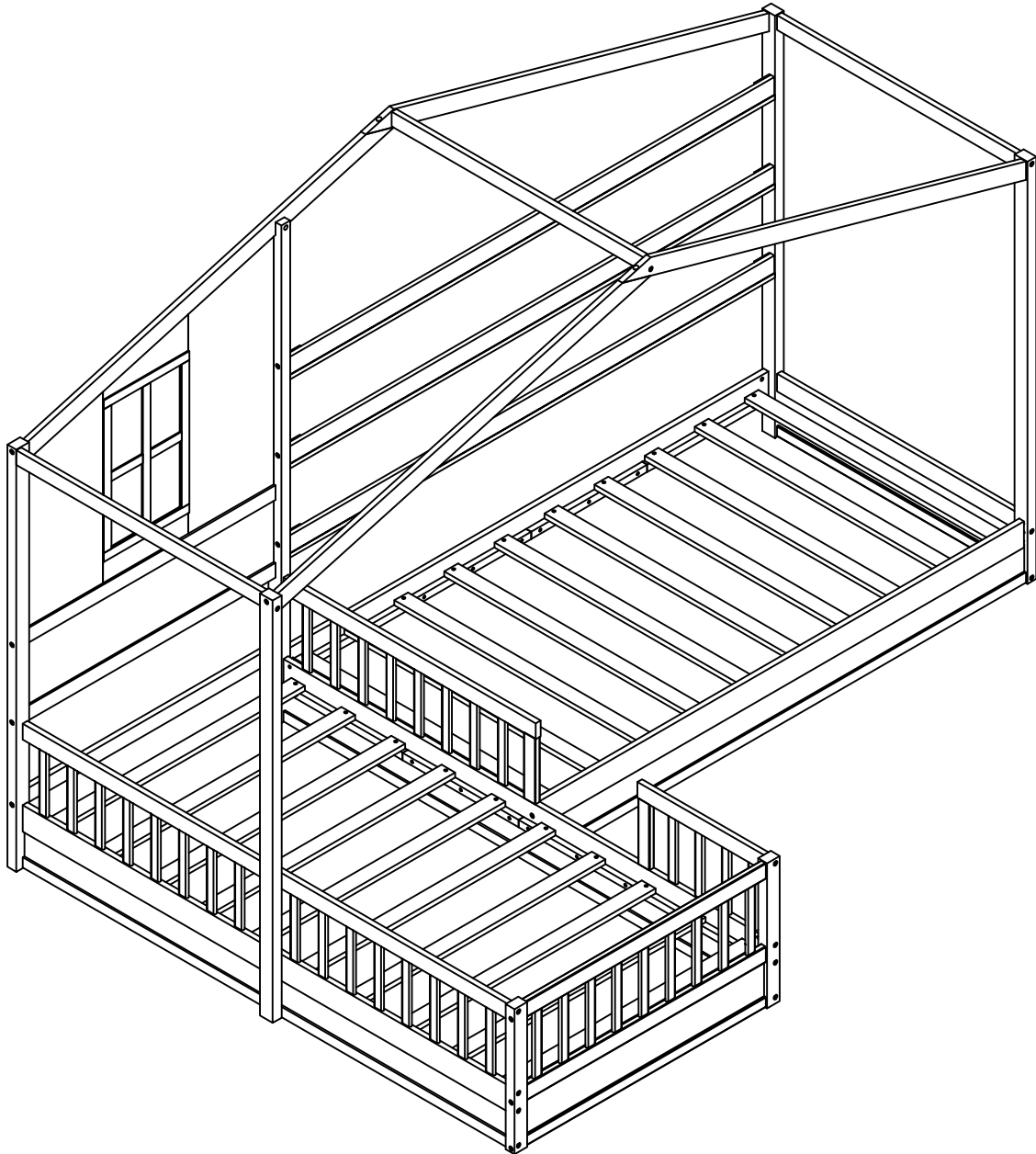

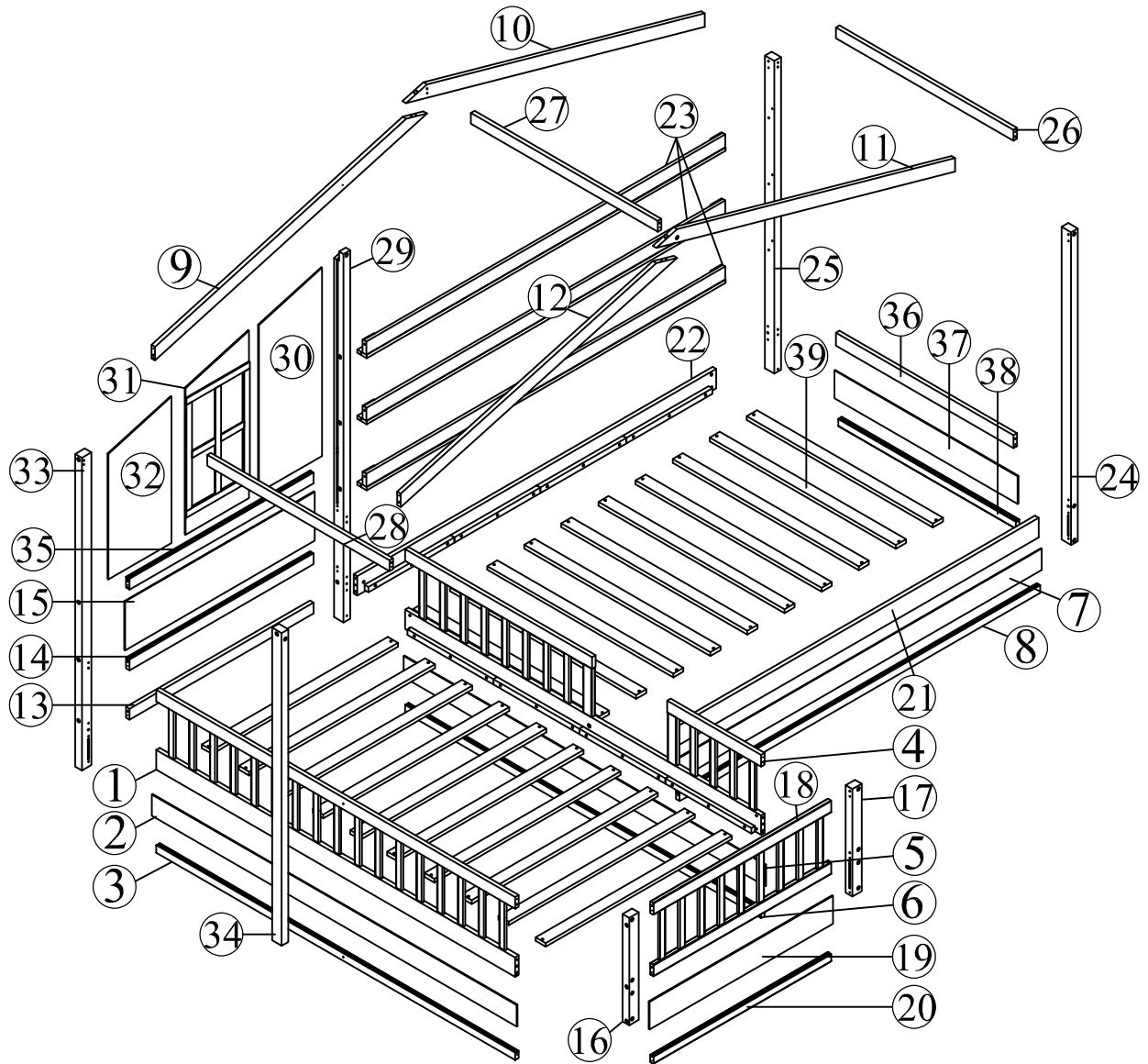

SKU CODE: WF292740/WF292741



Detail view

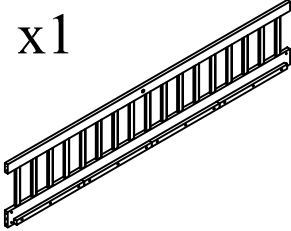
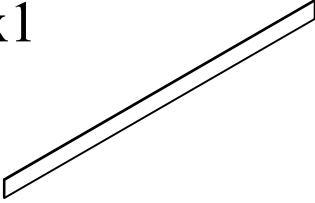
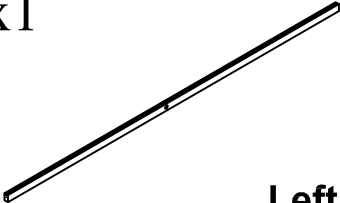
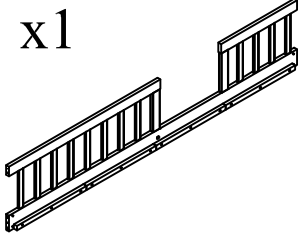
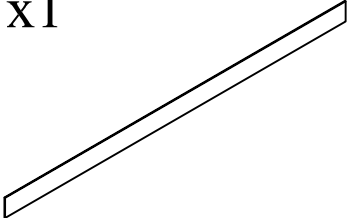
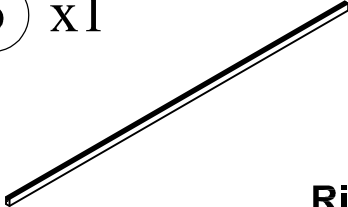
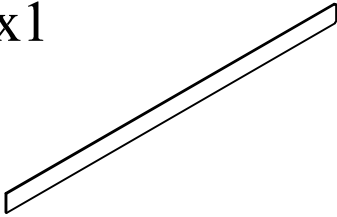
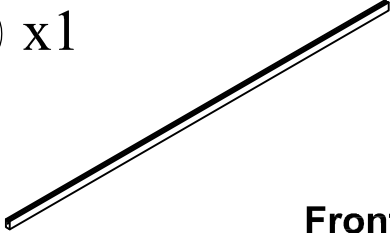
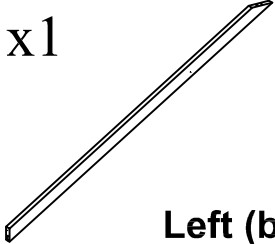

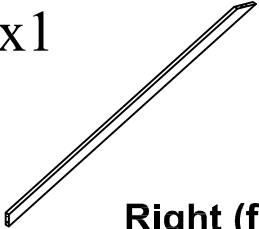
Part List (WF292741)

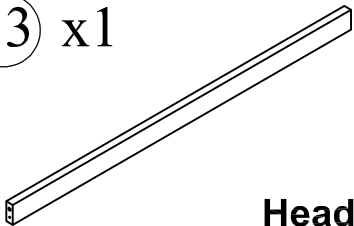
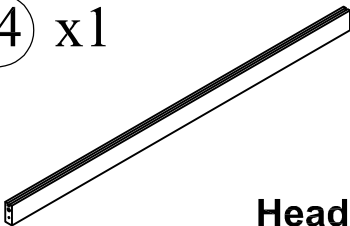
<p>① x1</p>  <p>Left rail</p>	<p>② x1</p>  <p>Panel</p>
<p>③ x1</p>  <p>Left upper rail</p>	<p>④ x1</p>  <p>Right rail</p>
<p>⑤ x1</p>  <p>Panel</p>	<p>⑥ x1</p>  <p>Right upper rail</p>
<p>⑦ x1</p>  <p>Panel</p>	<p>⑧ x1</p>  <p>Front side rail</p>
<p>⑨ x1</p>  <p>Left (back) top guard</p>	<p>⑩ x1</p>  <p>Right (back) top guard</p>
<p>⑪ x1</p>  <p>Right (front) top guard</p>	<p>⑫ x1</p>  <p>Left (front) top guard</p>
<p>⑬ x1</p>  <p>Headboard guard</p>	<p>⑭ x1</p>  <p>Headboard guard</p>

Part List (WF292741)

15 x1

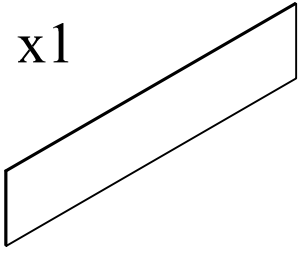



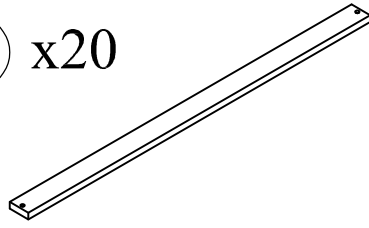

Panel

39 x20



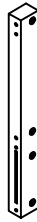
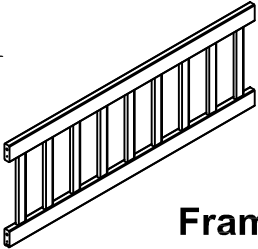
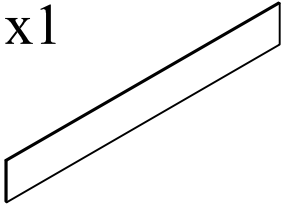
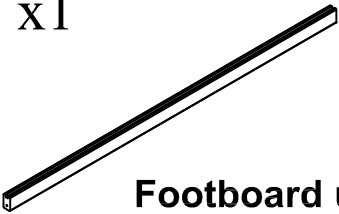
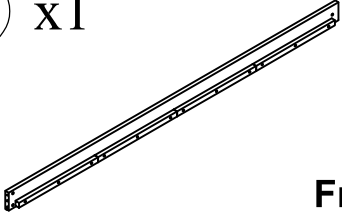
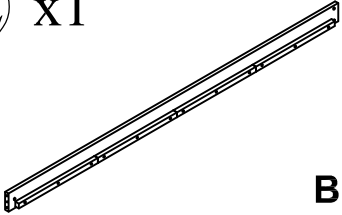
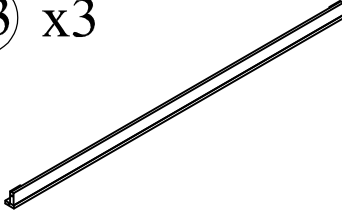

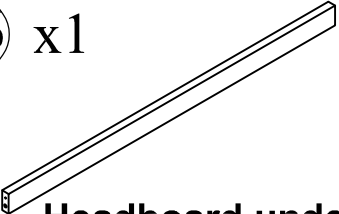
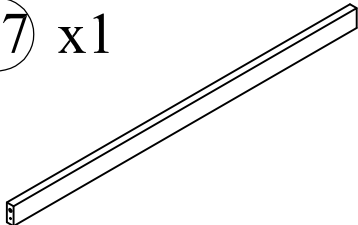
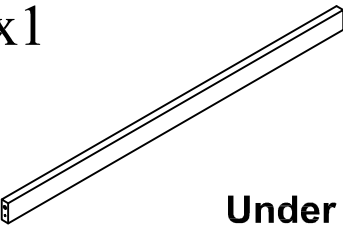

Slats



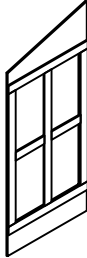



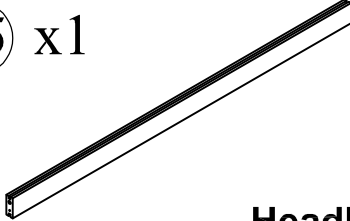
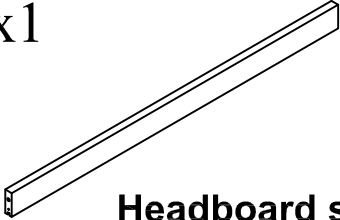
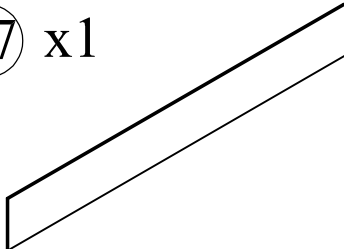
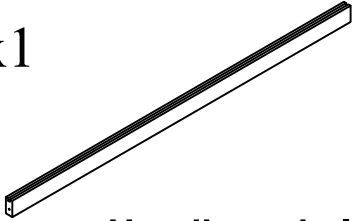

Part List (WF292740)

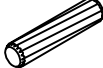
<p>①6 x1 </p> <p style="text-align: center;">Footboard left leg</p>	<p>①7 x1 </p> <p style="text-align: center;">Footboard right leg</p>
<p>①8 x1 </p> <p style="text-align: center;">Frame footboard</p>	<p>①9 x1 </p> <p style="text-align: center;">Panel</p>
<p>②0 x1 </p> <p style="text-align: center;">Footboard upper guard</p>	<p>②1 x1 </p> <p style="text-align: center;">Front side rail</p>
<p>②2 x1 </p> <p style="text-align: center;">Back side rail</p>	<p>②3 x3 </p> <p style="text-align: center;">Bookshelfts</p>
<p>②4 x1 </p> <p style="text-align: center;">Headboard front side leg</p>	<p>②5 x1 </p> <p style="text-align: center;">Headboard back side leg</p>
<p>②6 x1 </p> <p style="text-align: center;">Headboard under right guard</p>	<p>②7 x1 </p> <p style="text-align: center;">Under guard</p>
<p>②8 x1 </p> <p style="text-align: center;">Under left guard</p>	<p>②9 x1 </p> <p style="text-align: center;">Headboard right leg</p>

Part List (WF292740)

<p>③① x1</p>  <p>Headboard panel</p>	<p>③② x1</p>  <p>Headboard panel</p>
<p>③② x1</p>  <p>Headboard panel</p>	<p>③③ x1</p>  <p>Headboard left leg</p>
<p>③④ x1</p>  <p>Support leg</p>	<p>③⑤ x1</p>  <p>Headboard guard</p>
<p>③⑥ x1</p>  <p>Headboard side guard</p>	<p>③⑦ x1</p>  <p>Panel</p>
<p>③⑧ x1</p>  <p>Headboard side guard</p>	



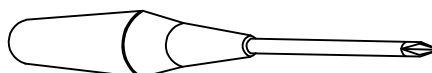

Hardware List (WF292740)

No.	OUTLOOK	DESC	QTY
(A)		Dowel Ø8*30mm	34
(B)		Dowel Ø10*40mm	10
(C)		Screws Ø6.5*30mm	03
(E)		Allen key 60*22*4mm	01
(F)		Bolts 1/4"*30mm	02
(H)		Bolts 1/4"*70mm	35
(I)		Bolts 1/4"*100mm	21
(J)		Brass fin insert 1/4"*13mm	56
(K)		Screws Ø8*25mm	40

ASSEMBLY TOOLS REQUIRED (NOT INCLUDED)





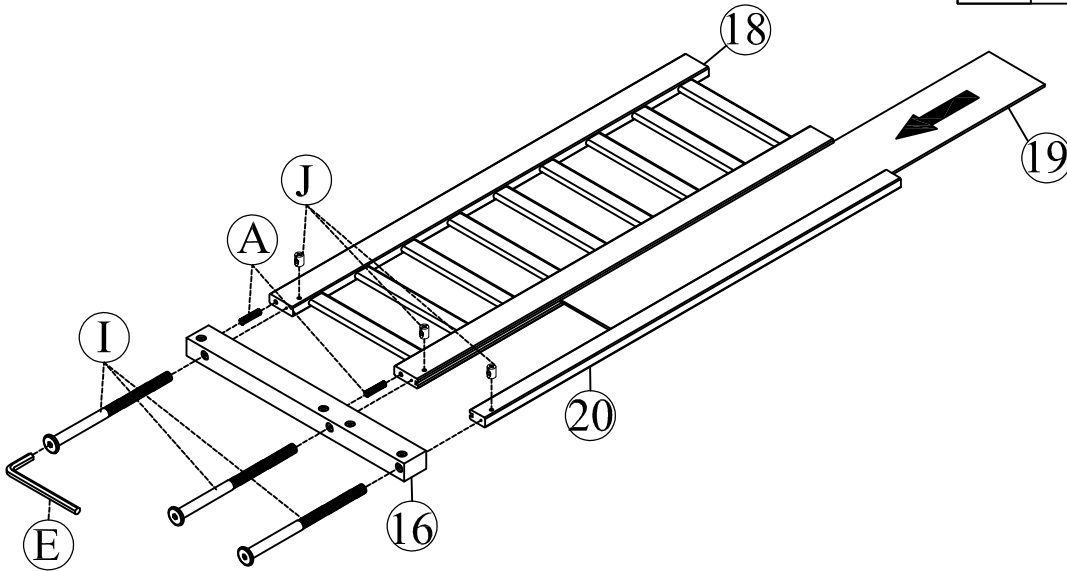

STEP 1:

(A)		02
(I)		03
(J)		03
(E)		01







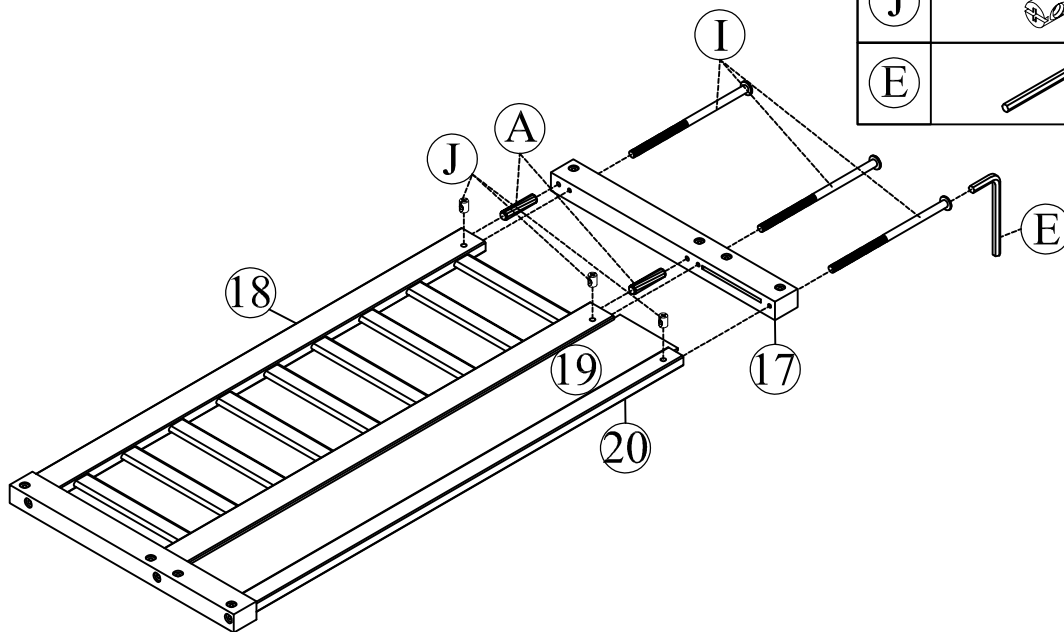

STEP 2:

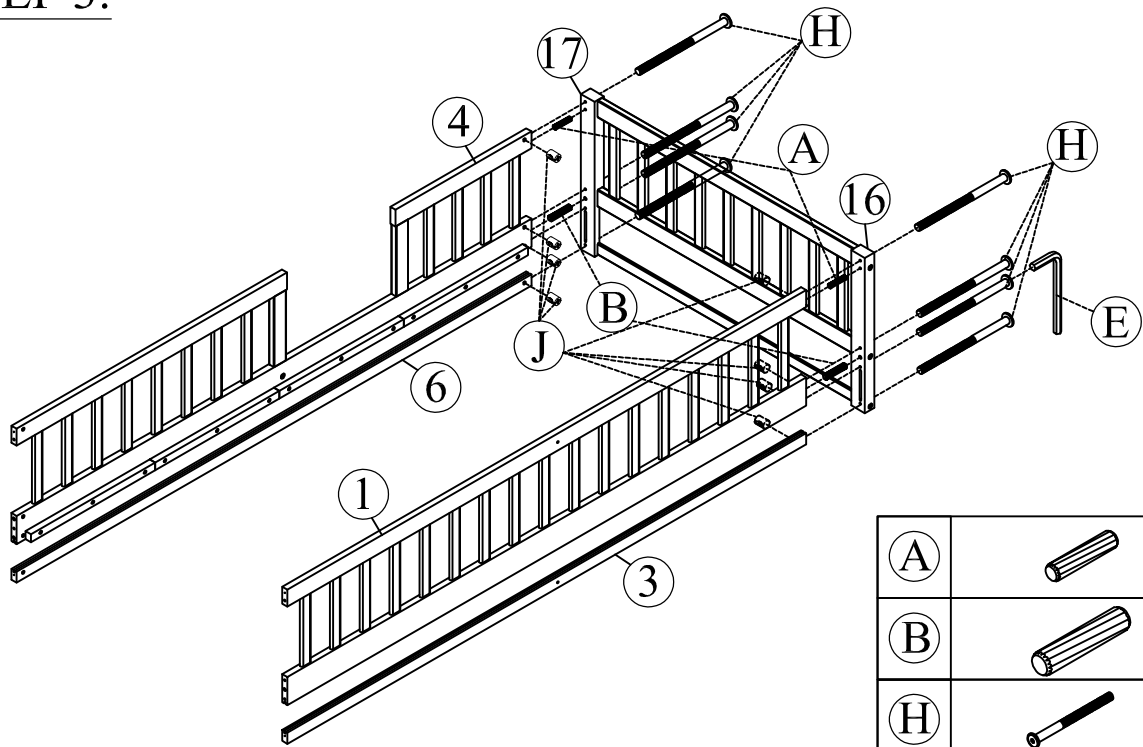
(A)		02
(I)		03
(J)		03
(E)		01

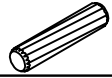

STEP 3:





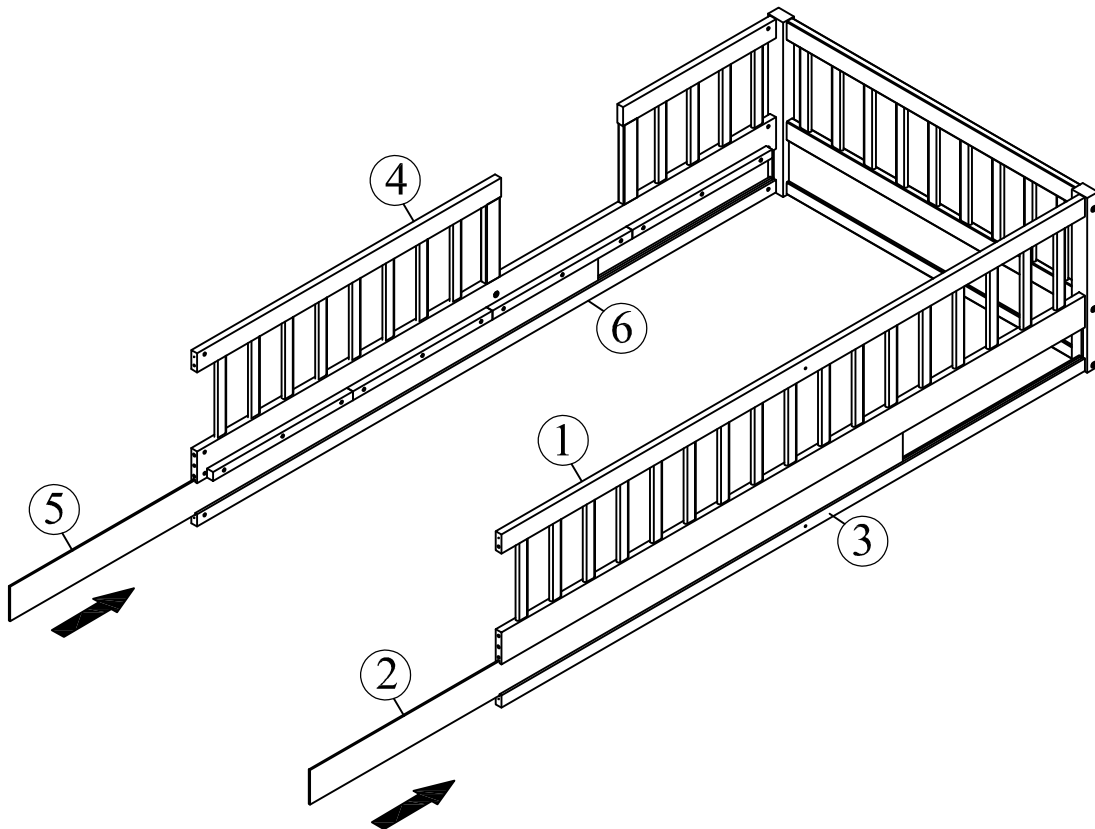

(A)		02
(B)		02
(H)		08
(J)		08
(E)		01

STEP 4:





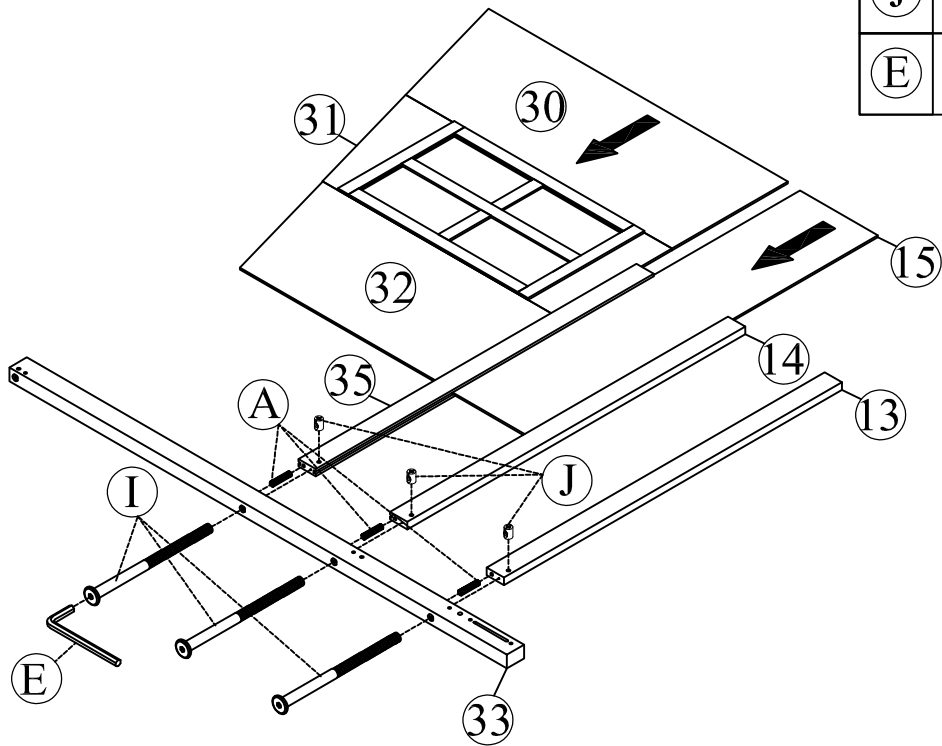

STEP 5:

(A)		03
(I)		03
(J)		03
(E)		01



STEP 6:

(A)		03
(H)		03
(J)		03
(E)		01

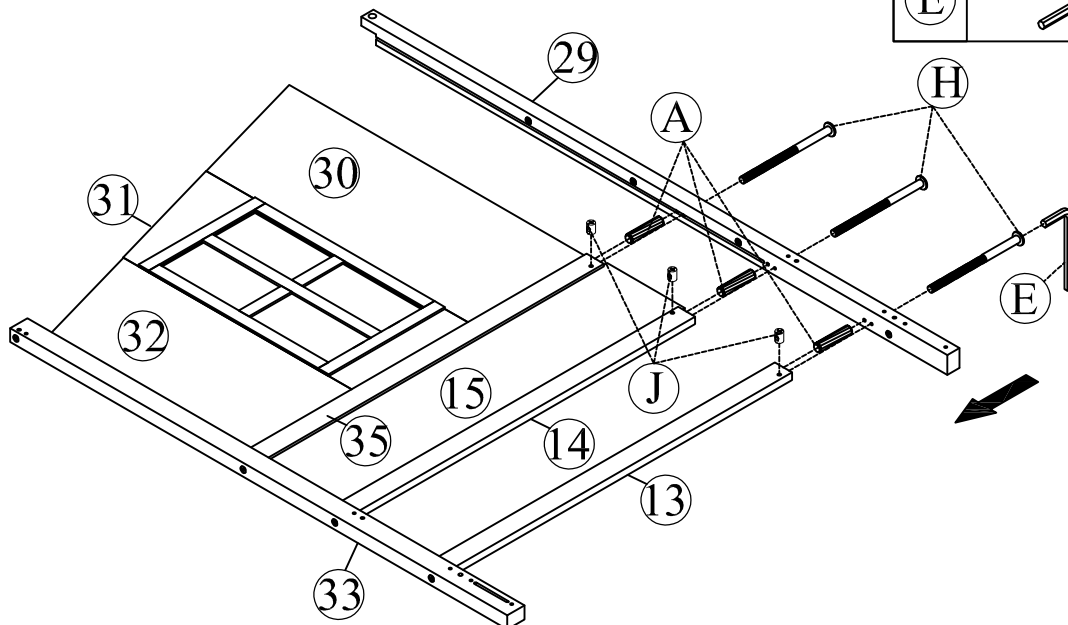

STEP 7:

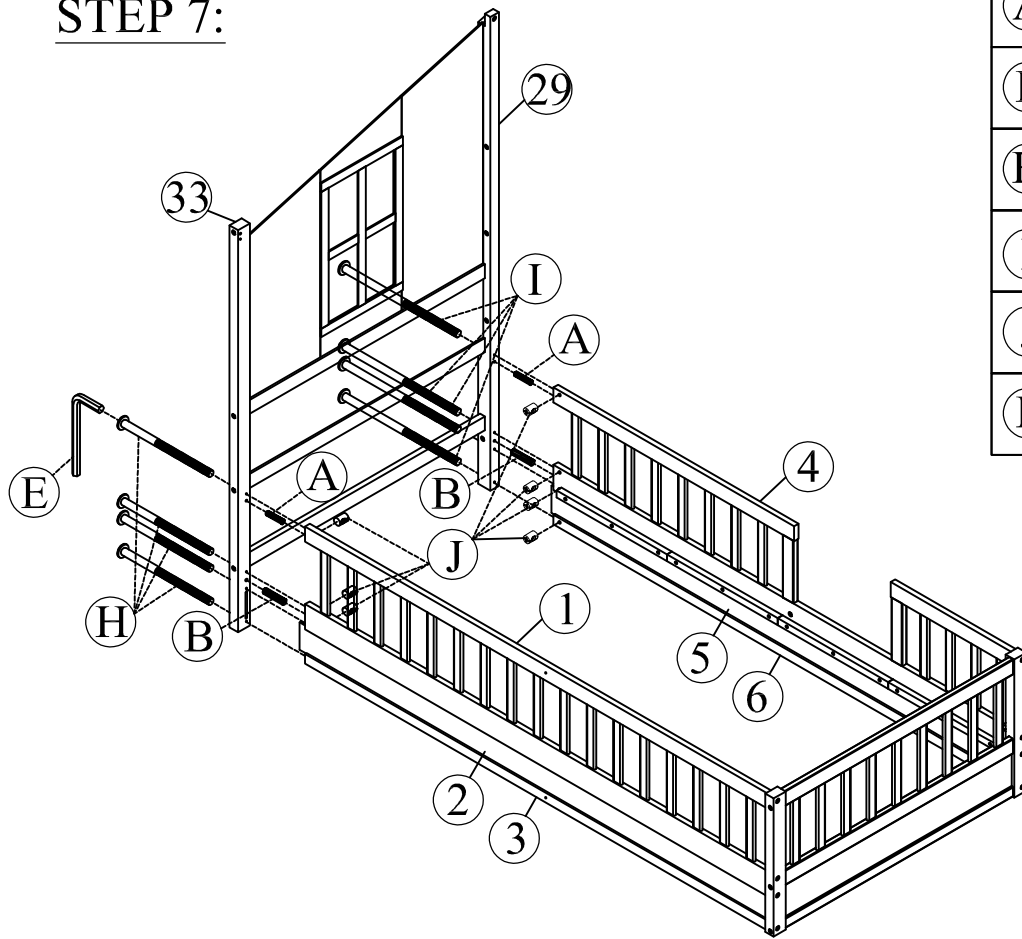



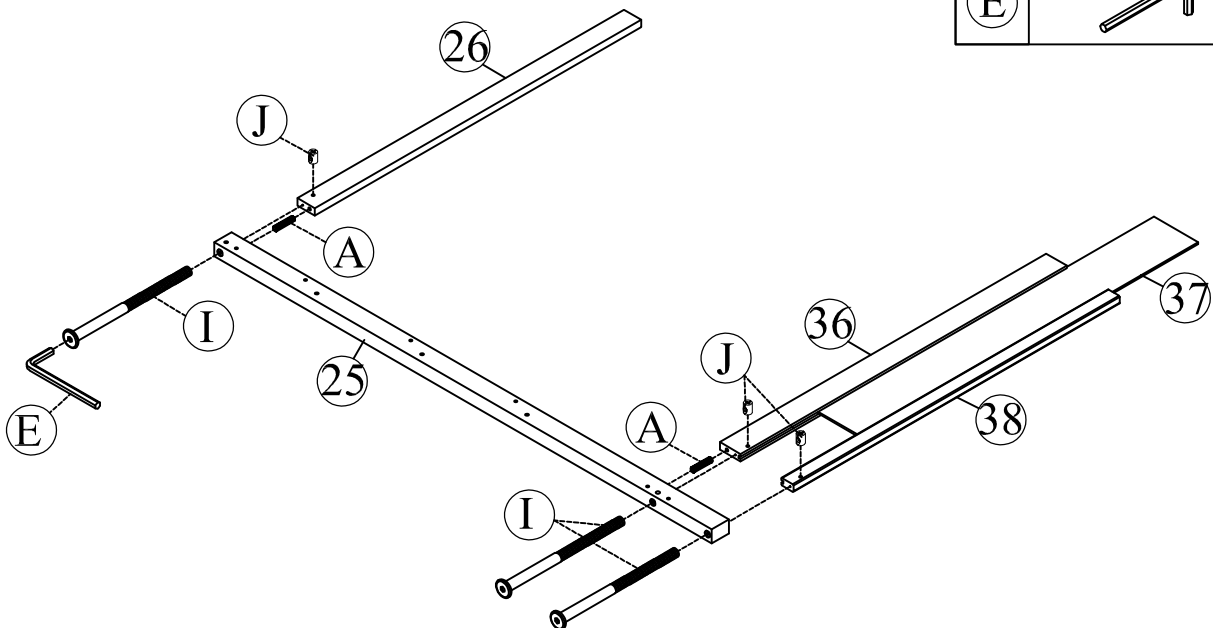

(A)		02
(B)		02
(H)		04
(I)		04
(J)		06
(E)		01

STEP 8:





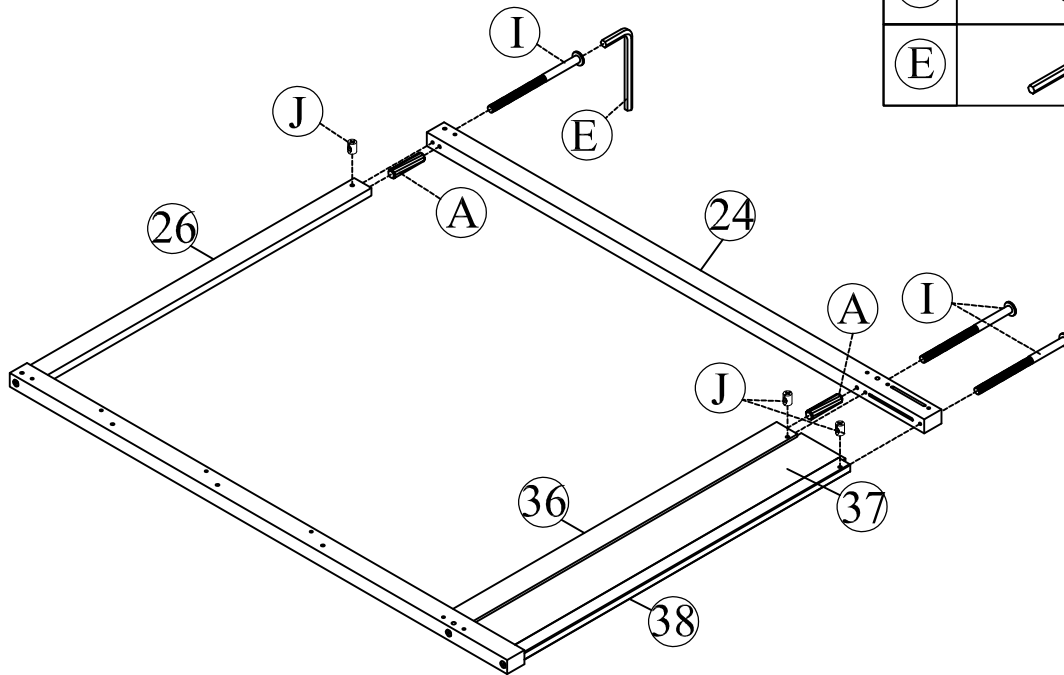

(A)		02
(I)		03
(J)		03
(E)		01

STEP 9:

(A)		02
(I)		03
(J)		03
(E)		01





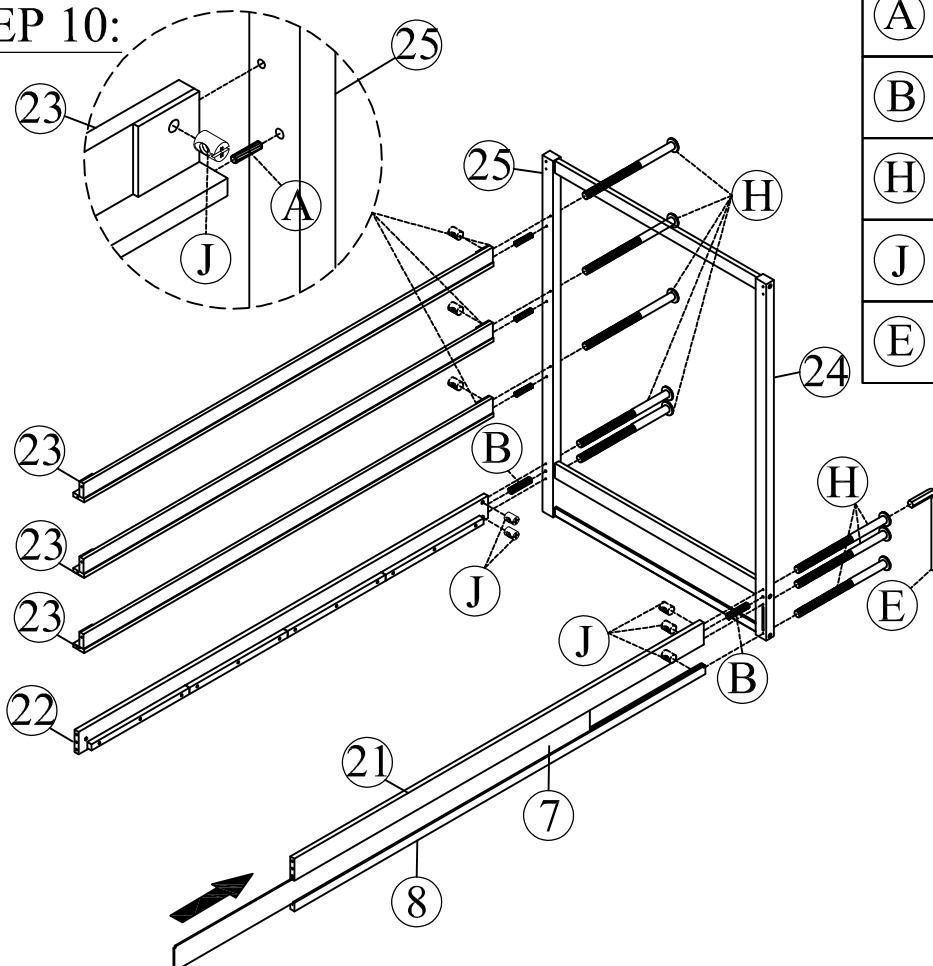

STEP 10:

(A)		03
(B)		02
(H)		08
(J)		08
(E)		01





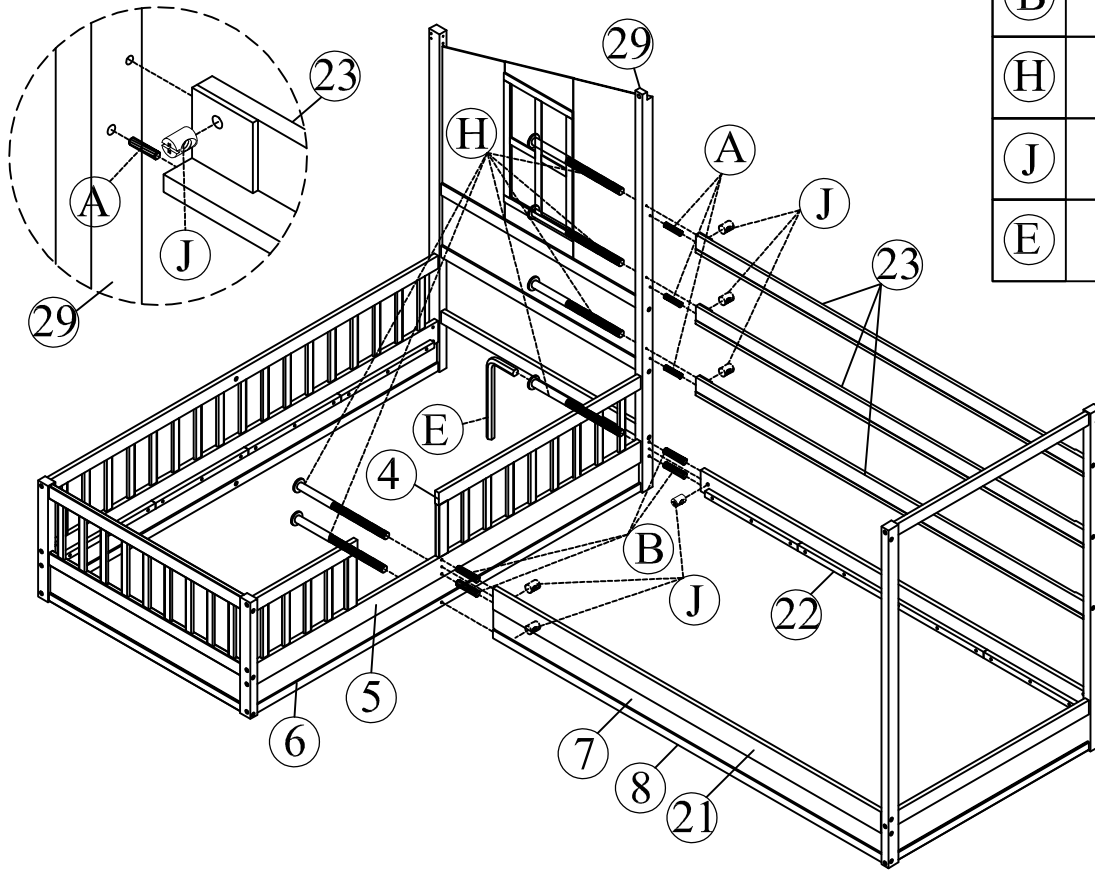

STEP 11:

(A)		03
(B)		04
(H)		06
(J)		06
(E)		01



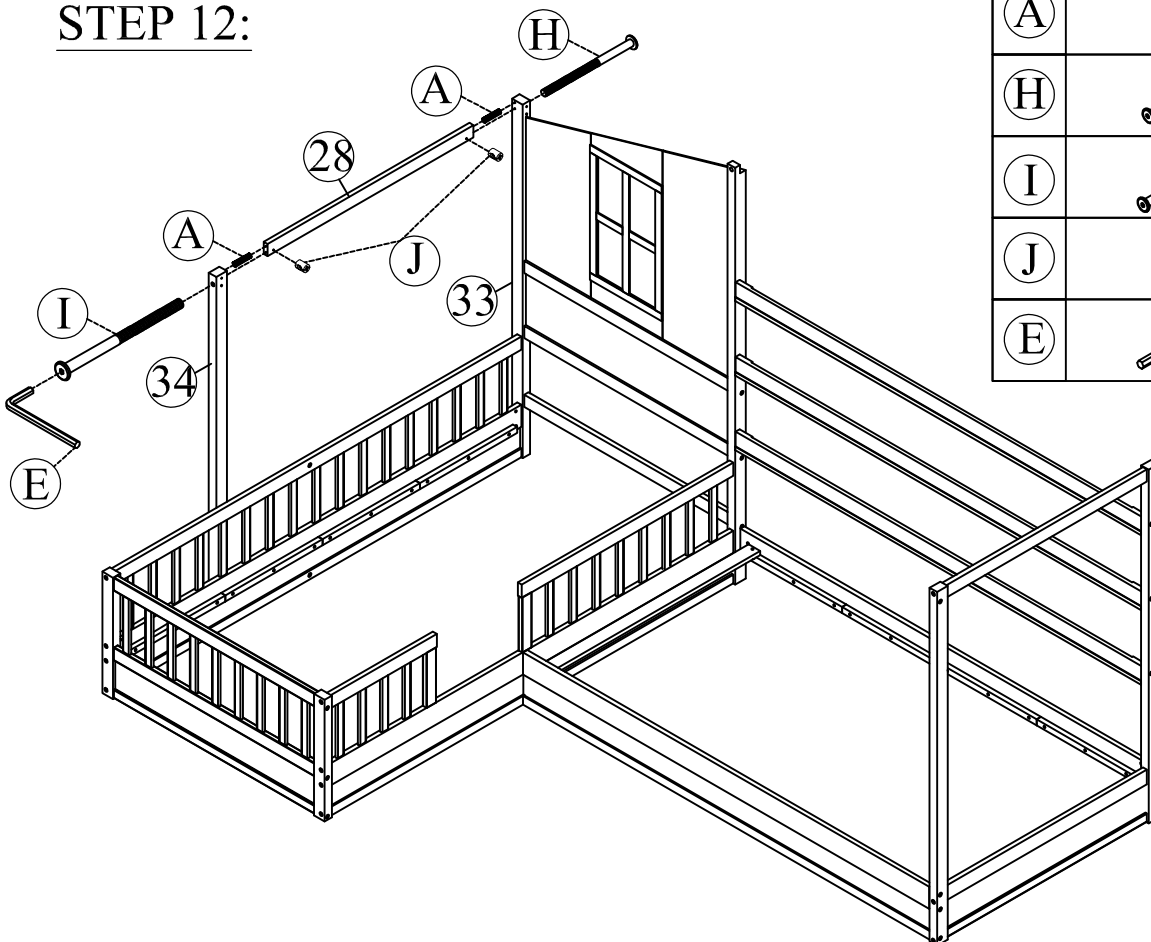

STEP 12:

(A)		02
(H)		01
(I)		01
(J)		02
(E)		01



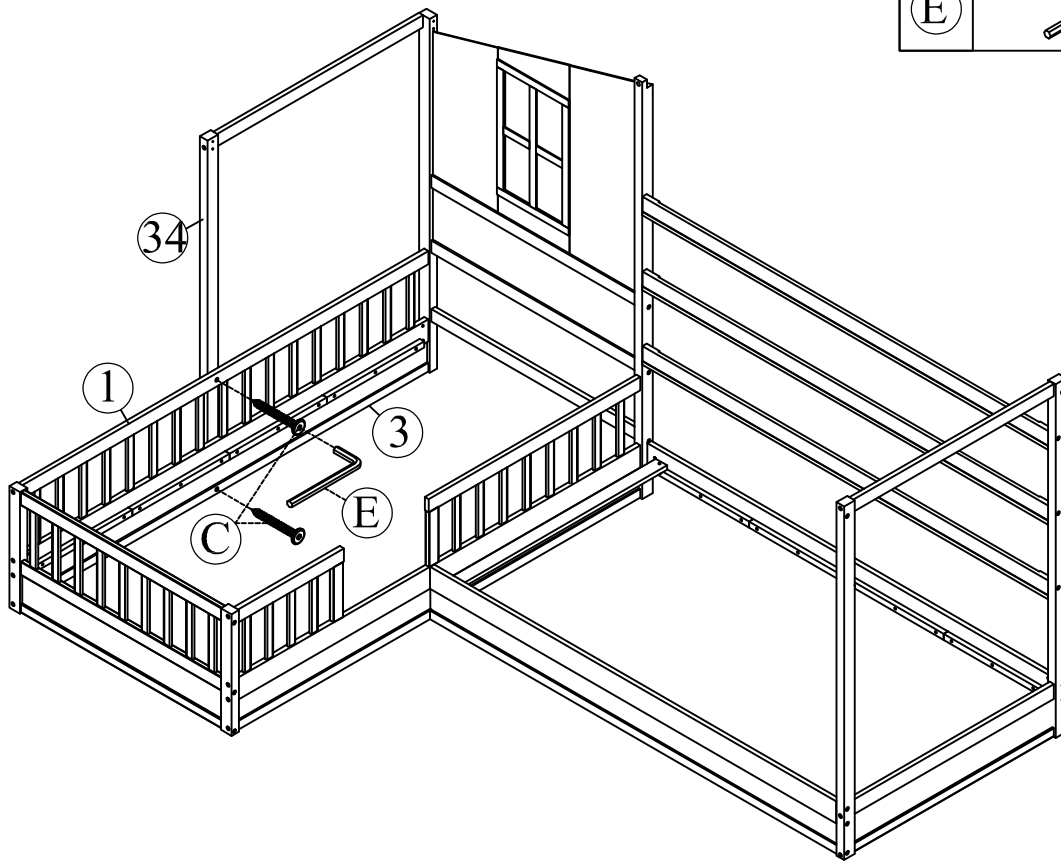

STEP 13:

(C)		02
(E)		01





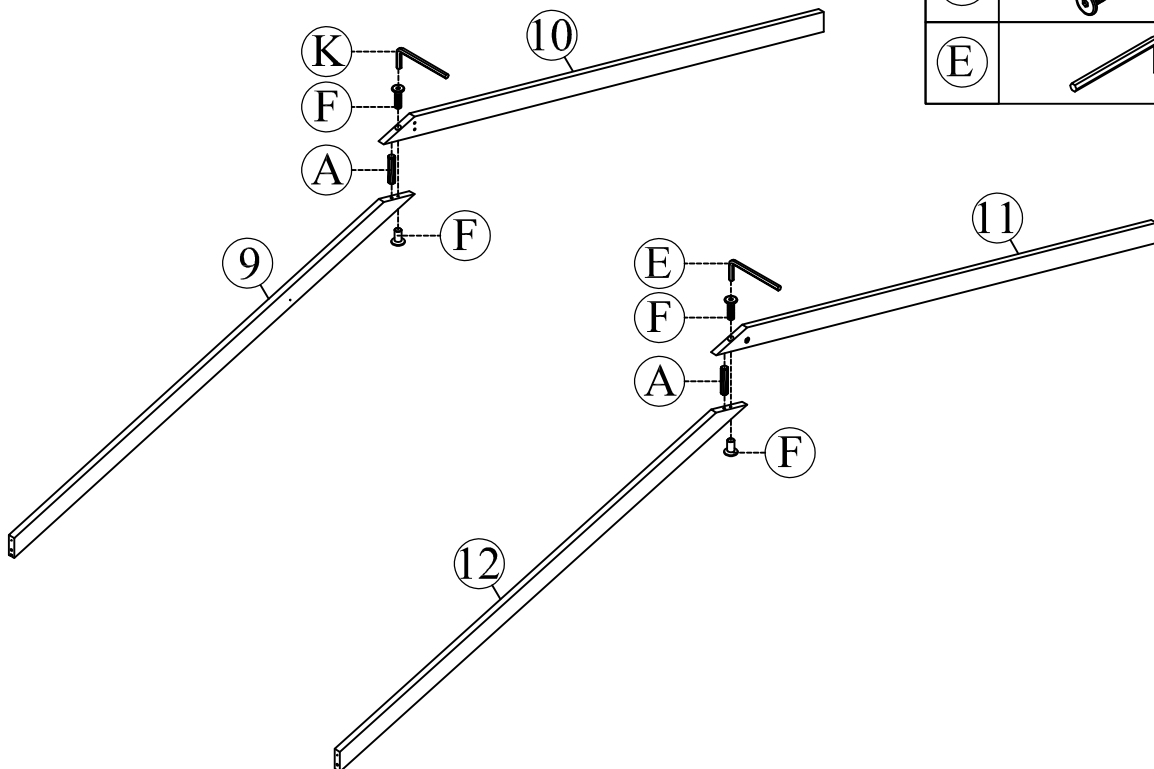

STEP 14:

(A)		02
(F)		02
(E)		01





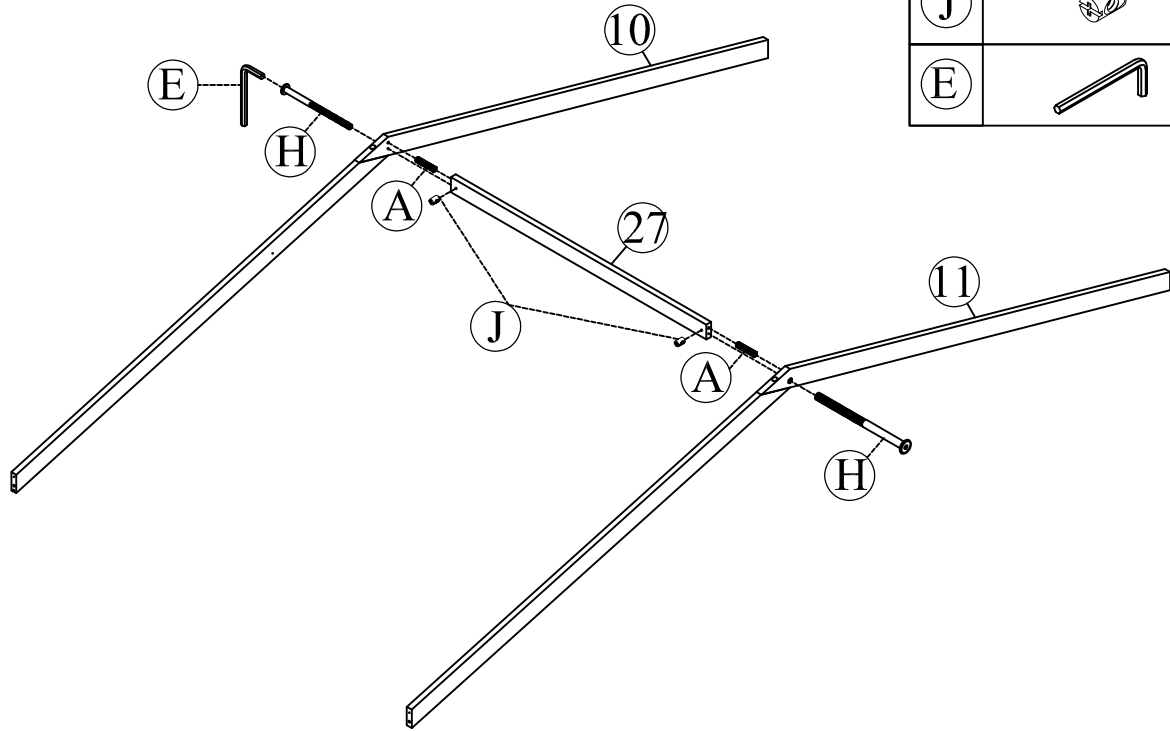

STEP 15:

(A)		02
(H)		02
(J)		02
(E)		01



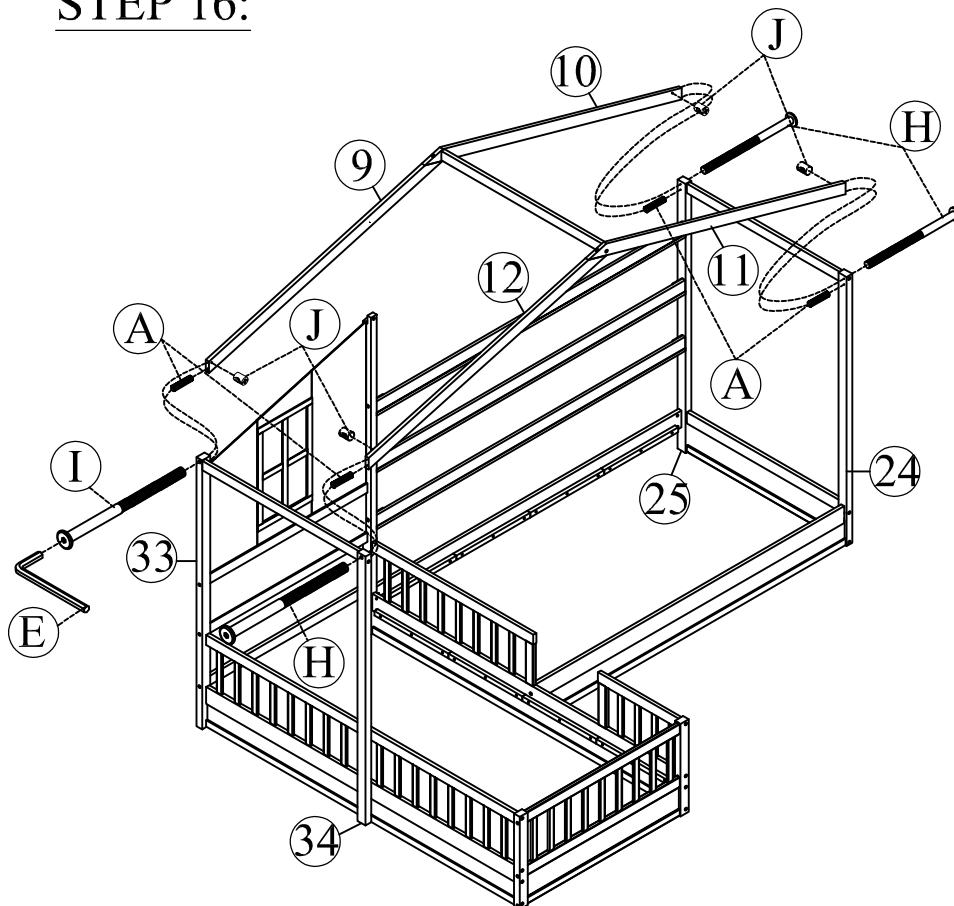

STEP 16:

(A)		04
(H)		01
(I)		03
(J)		04
(E)		01

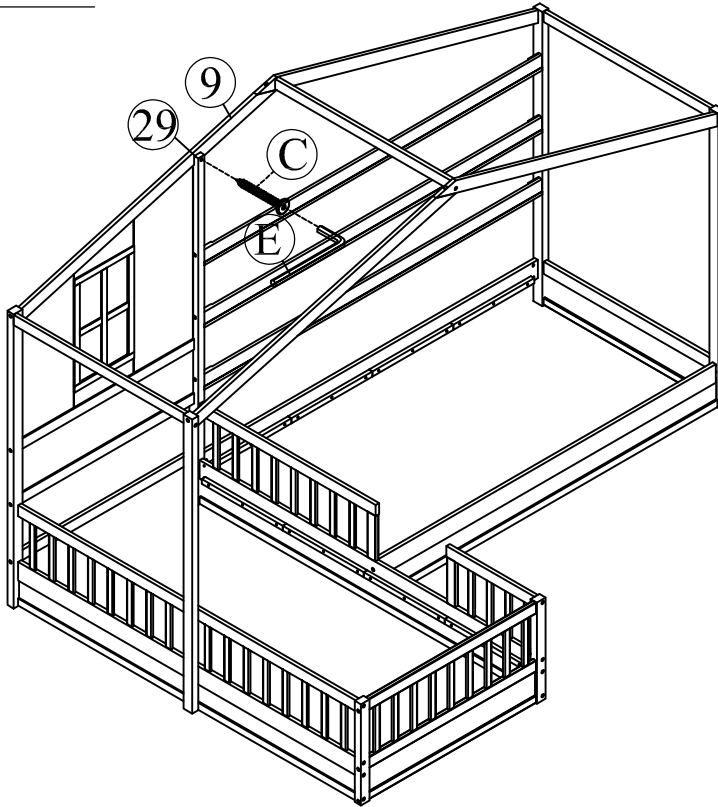

STEP 17:



(C)		01
(E)		01

STEP 18:

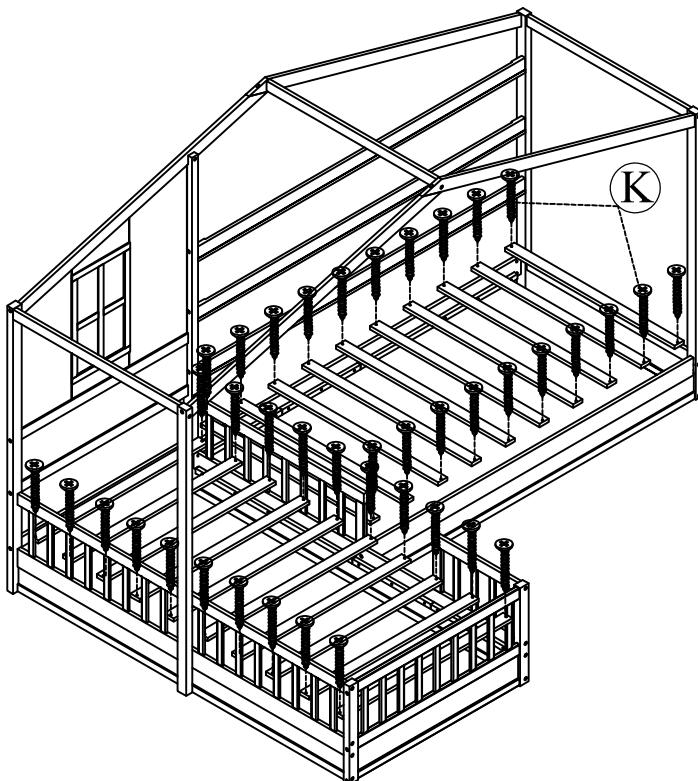

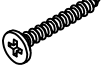
(K)		40
-----	---	----

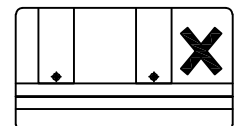
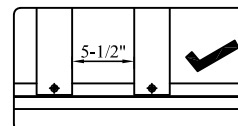

FINAL:

