

ASSEMBLY INSTRUCTION

SKU CODE: (WF303690-WF303691)

This set is included 2 boxes if don't receive full 2 boxes please contact our customer service team

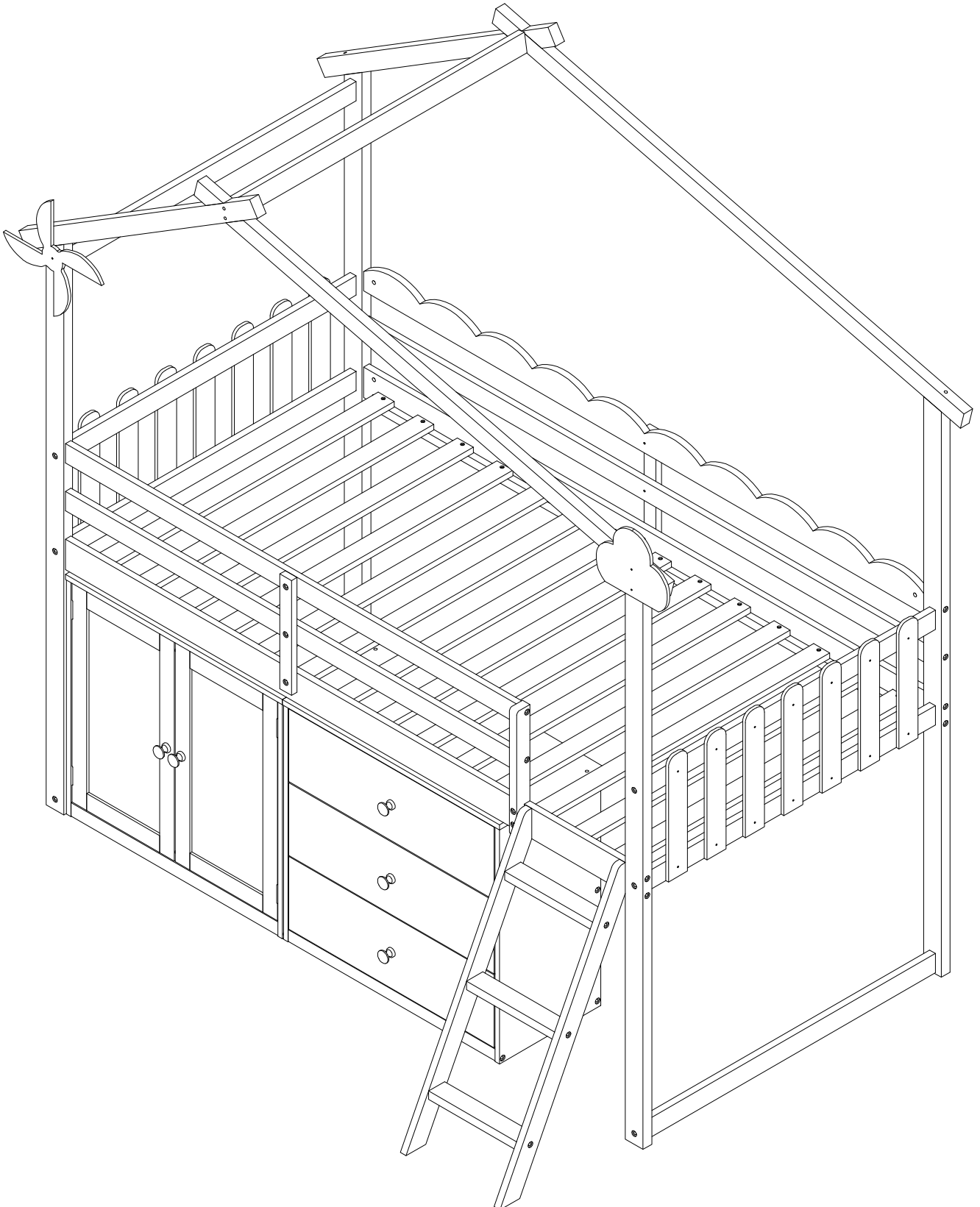

! SAFETY WARNINGS !

1. This bed is designed for use only mattress (es) meeting the following specifications on the upper bunk, and lower bunk







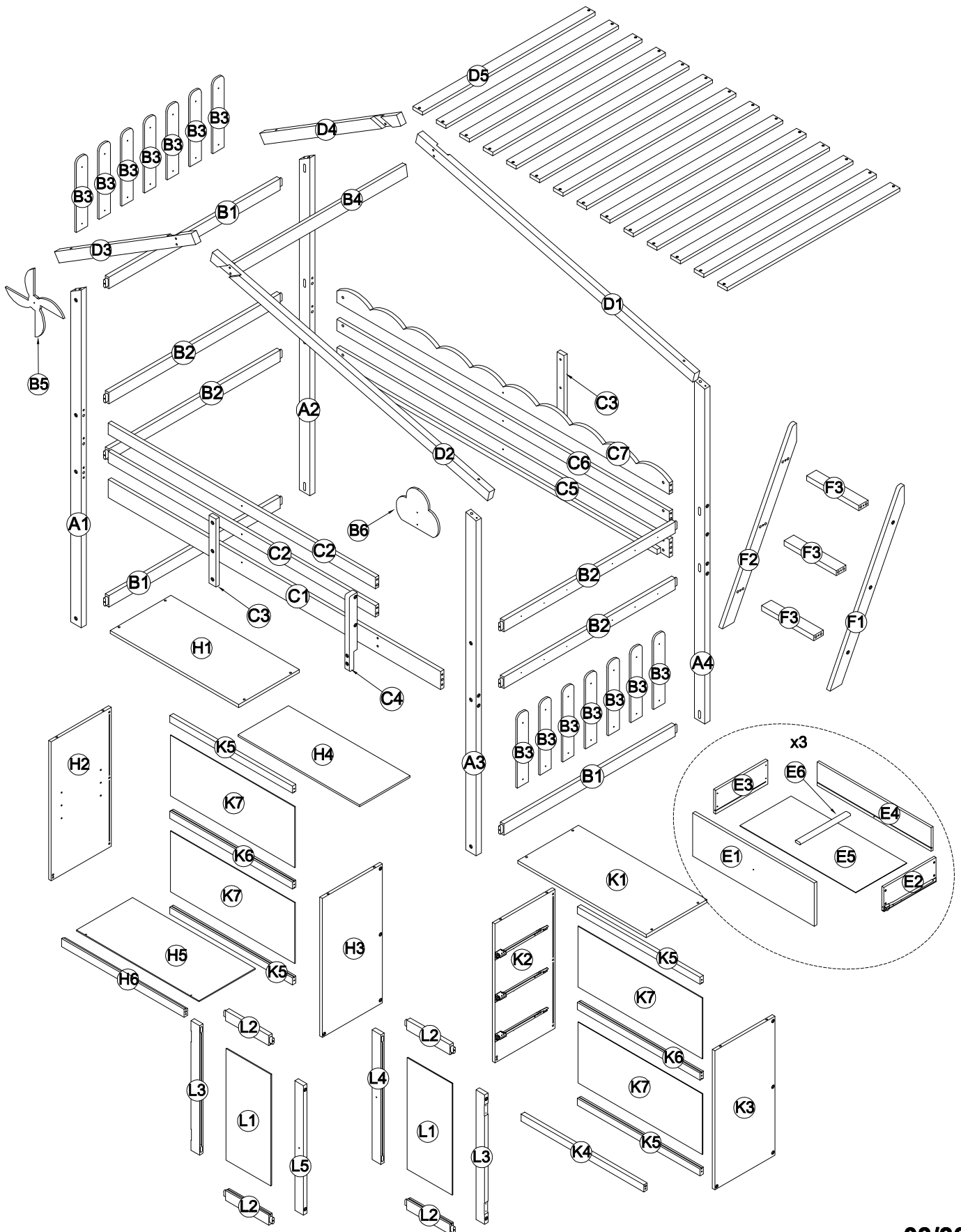

Bed Type	Length	Width	Thickness
<i>Twin Standard</i>	<i>74" - 75"</i>	<i>38 1/2"</i>	<i>6" max</i>

2. Replacement parts, including additional guardrails, maybe obtained from any of our (GIGACLOUD TECHNOLOGY (USA) INC. 18961 ARENTH AVENUE CITY OF INDUSTRY, CA, 91748) dealers
3. Follow the information on the warnings appearing on the upper bunk bed end structure and on the carton. Do not remove warning label from bed
4. Always use the recommended size mattresses or mattress supports, or both, to help prevent the likelihood of entrapment or falls.
5. Surface of mattress must be at least 5" (127mm) below the upper edge of guardrails
6. Do not allow children under 6 years of age to use the upper bunk.
7. Periodically check and ensure that the guardrail, ladder, and other components are in their proper position, free from damage, and that all connectors are tight.
8. Do not allow horseplay on or under the bed and prohibit jumping on the bed.
9. Always use the ladder for entering and leaving the upper bunkAlways use the ladder for entering and leaving the upper bunk.
10. Do not use substitute part. Contact the manufacture or dealer for replacement part
11. Use of a night light may provide added safety precaution for a child using the upper bunk..
12. Always use guardrails on both long sides of the upper bunk. If the bunk bed will be placed next to the wall, the guardrail that runs the full length of the bed should be placed against the wall to prevent entrapment between the bed and wall.
13. The use of water or sleep flotation mattresses is prohibited
14. STRANGULATION HAZARD - Never attach or hang items to any part of the bunk bed that are not designed for use with the bed; for example, but not limited to, hook, belts and jump ropes
15. Keep these instruction for future reference
16. Prohibit more than one person on upper bunk
17. We recommend assembling your bunk bed on the shipping carton to protect your floor or carpet
18. Be certain all staples are out of the box before beginning assembly on the shipping carton.

ASSEMBLY INSTRUCTION

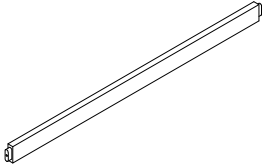
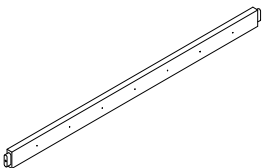
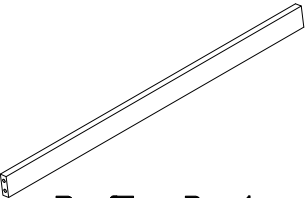
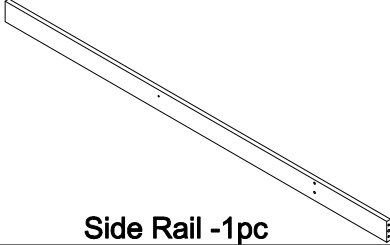
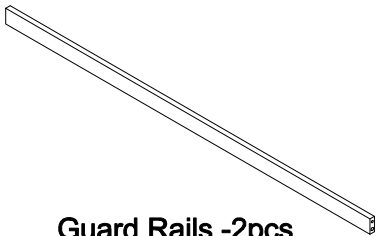

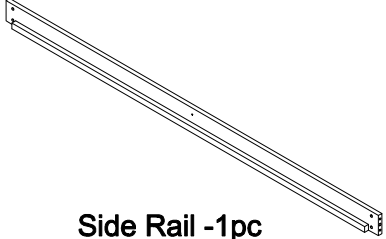
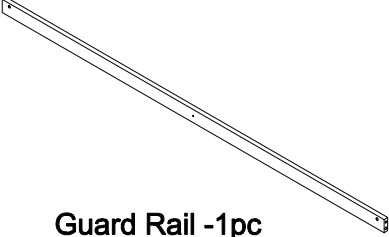
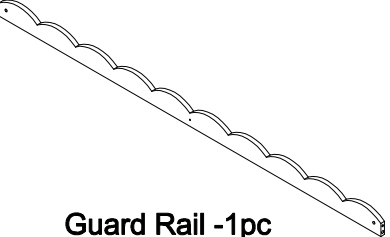
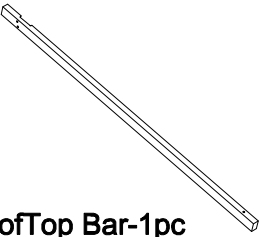
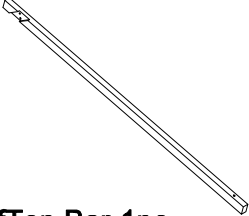
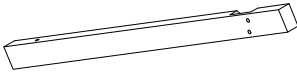
Part List & Hardware List (Box 1-WF303690)

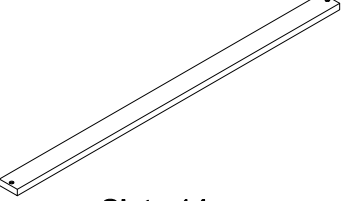
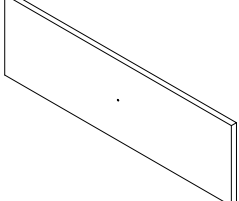
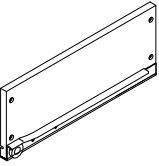
<p>A1</p>  <p>Leg-1pc</p>	<p>A2</p>  <p>Leg-1pc</p>	<p>A3</p>  <p>Leg-1pc</p>
<p>A4</p>  <p>Leg-1pc</p>	<p>B1</p>  <p>Wood Bars-3pcs</p>	<p>B2</p>  <p>Wood Bars-4pcs</p>
<p>B4</p>  <p>RoofTop Bar-1pc</p>	<p>C1</p>  <p>Side Rail -1pc</p>	<p>C2</p>  <p>Guard Rails -2pcs</p>
<p>C3</p>  <p>Support Side Rails -2pcs</p>	<p>C4</p>  <p>Rail -1pc</p>	<p>C5</p>  <p>Side Rail -1pc</p>
<p>C6</p>  <p>Guard Rail -1pc</p>	<p>C7</p>  <p>Guard Rail -1pc</p>	<p>D1</p>  <p>RoofTop Bar-1pc</p>
<p>D2</p>  <p>RoofTop Bar-1pc</p>	<p>D3</p>  <p>RoofTop Bar-1pc</p>	<p>D4</p>  <p>RoofTop Bar-1pc</p>
<p>D5</p>  <p>Slats-14pcs</p>	<p>E1</p>  <p>Drawer-Front Panels-3pcs</p>	<p>E2</p>  <p>Drawer-Side Panels-3pcs</p>

Part List & Hardware List (Box 1-WF303690)

E3

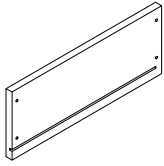

Drawer-Side Panels-3pcs

F1

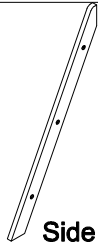

Side Stair-1pc

F2

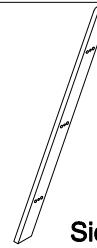





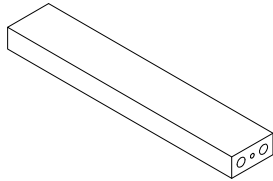

Side Stair-1pc

F3

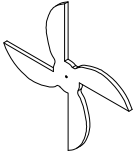
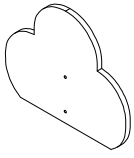
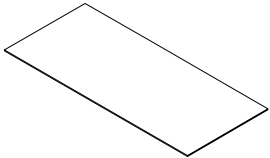
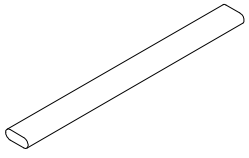
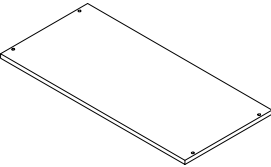
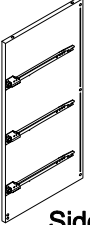
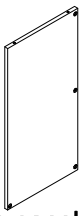
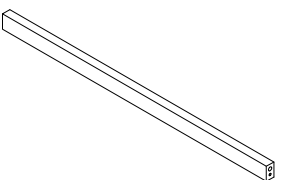

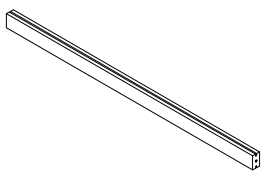
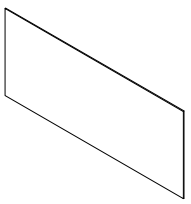
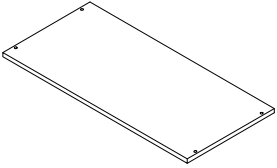
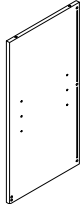
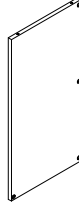
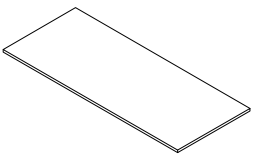
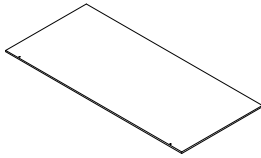
Step Stairs-3pcs

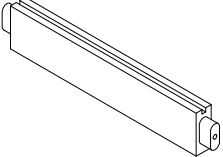
Part List (Box 2-WF303691)

<p>B3</p>  <p>Tiles-14pcs</p>	<p>B5</p>  <p>Propeller-1pc</p>	<p>B6</p>  <p>Cloud -1pc</p>
<p>E5</p>  <p>Drawer-Bottom Panels-3pcs</p>	<p>E6</p>  <p>Drawer-Support Bottom Panels-3pcs</p>	<p>K1</p>  <p>Top panel-1pc</p>
<p>K2</p>  <p>Side panel-1pc</p>	<p>K3</p>  <p>Side panel-1pc</p>	<p>K4</p>  <p>Wood Bar-1pc</p>
<p>K5</p>  <p>Wood Bars-4pcs</p>	<p>K6</p>  <p>Wood Bars-2pcs</p>	<p>K7</p>  <p>Back Panels-4pcs</p>
<p>H1</p>  <p>Top panel-1pc</p>	<p>H2</p>  <p>Side Panel-1pc</p>	<p>H3</p>  <p>Side Panel-1pc</p>
<p>H4</p>  <p>Remove Panel-1pc</p>	<p>H5</p>  <p>Bottom Panel-1pc</p>	<p>H6</p>  <p>Wood Bar-1pc</p>
<p>L1</p>  <p>Door-Panels-2pcs</p>	<p>L2</p>  <p>Door-Horizontal Bars-4pcs</p>	<p>L3</p>  <p>Door-Vetical Bars-2pcs</p>

Part List (Box 2-WF303691)

L4



Door-Vetical Bar-1pc

L5







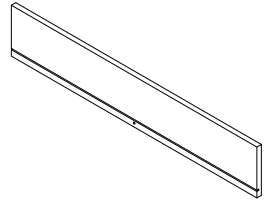



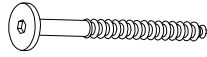

Door-Vetical Bar-1pc

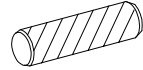
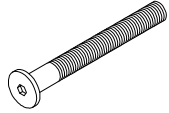
E4

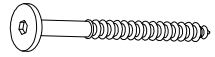

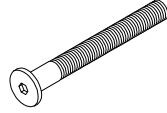
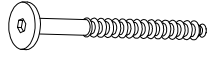
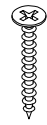
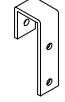
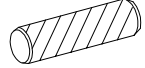
Drawer-Back Panels-3pcs

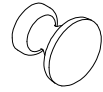
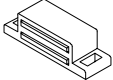
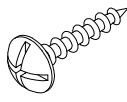
Hardware List (Box 1-WF303690)

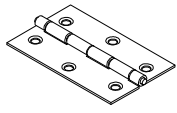
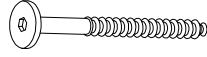
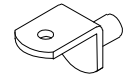
<p>1</p>  <p>Screws 1/4"x50mm 20pcs</p>	<p>2</p>  <p>M4 x 20 mm Wood Screws 37pcs</p>	<p>3</p>  <p>Ø10 x 40 mm Wood dowel 28pcs</p>
<p>4</p>  <p>Ø1/4" x 70 mm Hex-Head bolts 6pcs</p>	<p>5</p>  <p>Ø1/4" x 13 mm Horizontal-Hole bolts 20pcs</p>	<p>6</p>  <p>Screws 1/4"x30mm 22pcs</p>
<p>7</p>  <p>Ø1/4" x 15 mm Canopy head though -2pcs</p>	<p>8</p>  <p>Ø1/4" x 30mm Hex-Head bolts 10pcs</p>	<p>9</p>  <p>Ø1/4" x 100 mm Hex-Head bolts 14pcs</p>
<p>10</p>  <p>Screws 1/4"x70mm 4pcs</p>	<p>11</p>  <p>M4 x 30 mm Wood Screws 55pcs</p>	<p>12</p>  <p>Bracket 2 pcs</p>
<p>13</p>  <p>Ø8 x 30 mm Wood dowel 4pcs</p>	<p>14</p>  <p>Ø1/6" x 25 mm Hex-Head bolts 5pcs</p>	<p>15</p>  <p>Handle Wood 5pcs</p>
<p>16</p>  <p>Door Catches(45x17x13) 2pcs</p>	<p>17</p>  <p>M4 x 15 mm Wood Screws 6pcs</p>	<p>18</p>  <p>M3.5 x 12 mm Wood Screws 28pcs</p>
<p>19</p>  <p>Leaf hinge 4pcs</p>	<p>20</p>  <p>Screws 1/4"x60mm 8pcs</p>	<p>21</p>  <p>Dowel Remove Shelves 4pcs</p>

Hardware List (Box 1-WF303690)

22

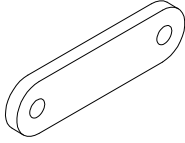

Magnet Inhaler -2pcs

23



Allen Key 1pc

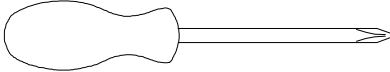

Assembly Tools Required (Not Included)

STEP 1: Following below illustration:

1.1: Using hardware #1 to Connect A1, A2 Legs With B1(x2), B2(x2) Wood Bars

1.2: Using hardware #2 to Connect B3(x7) With Frame (completed on step 1.1)

-Look at detail view for more detail

2	1
14pcs	8pcs

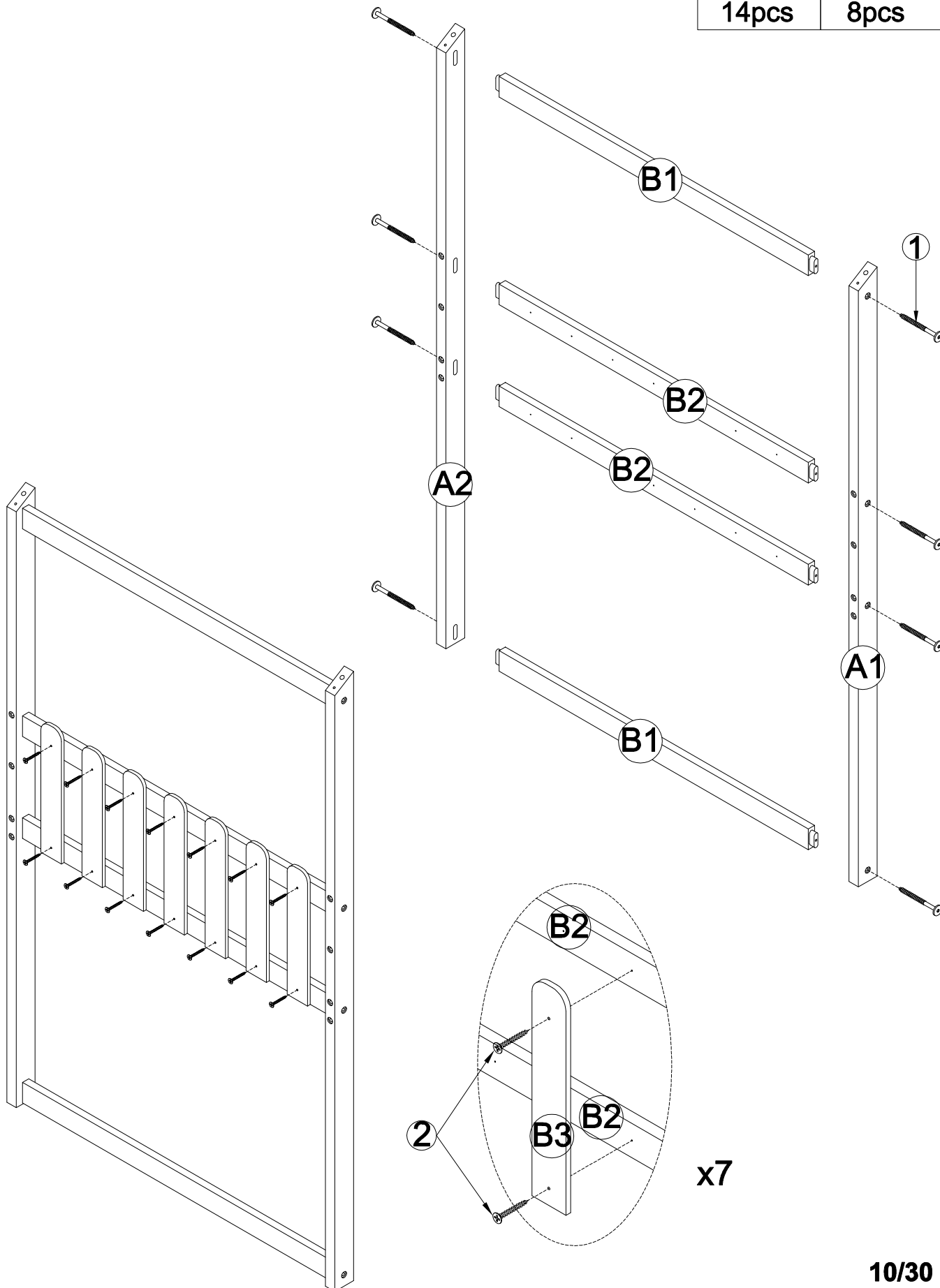

STEP 3: Following below illustration:

5



4pcs

4

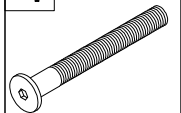

4pcs

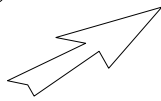
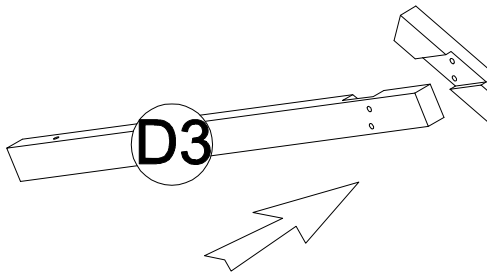
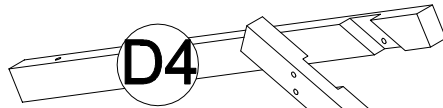

D1

D2

D3

D4

D4

B4

D1

D3



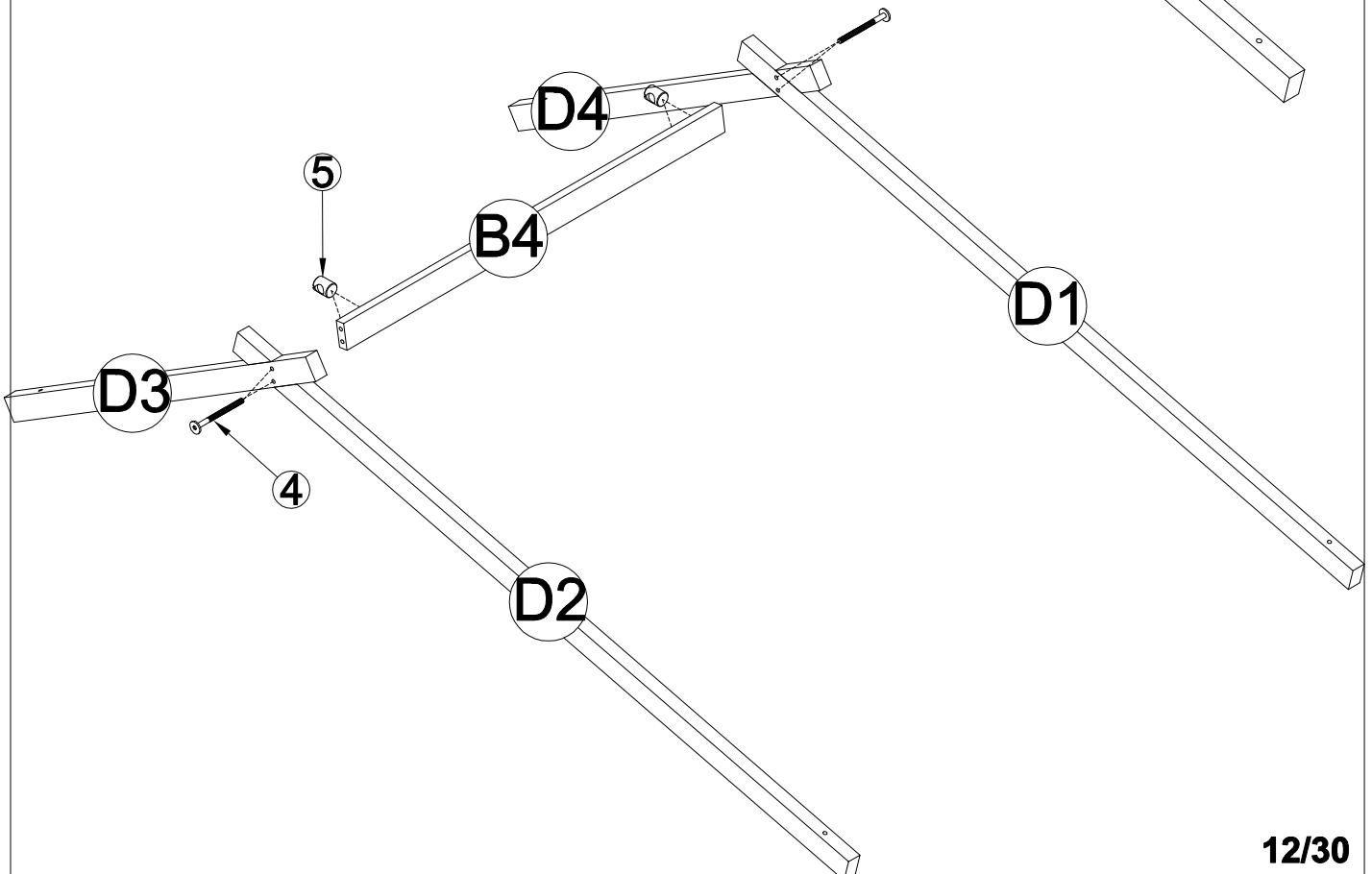

D2

4

5

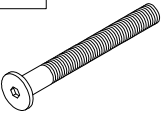
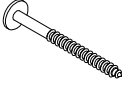

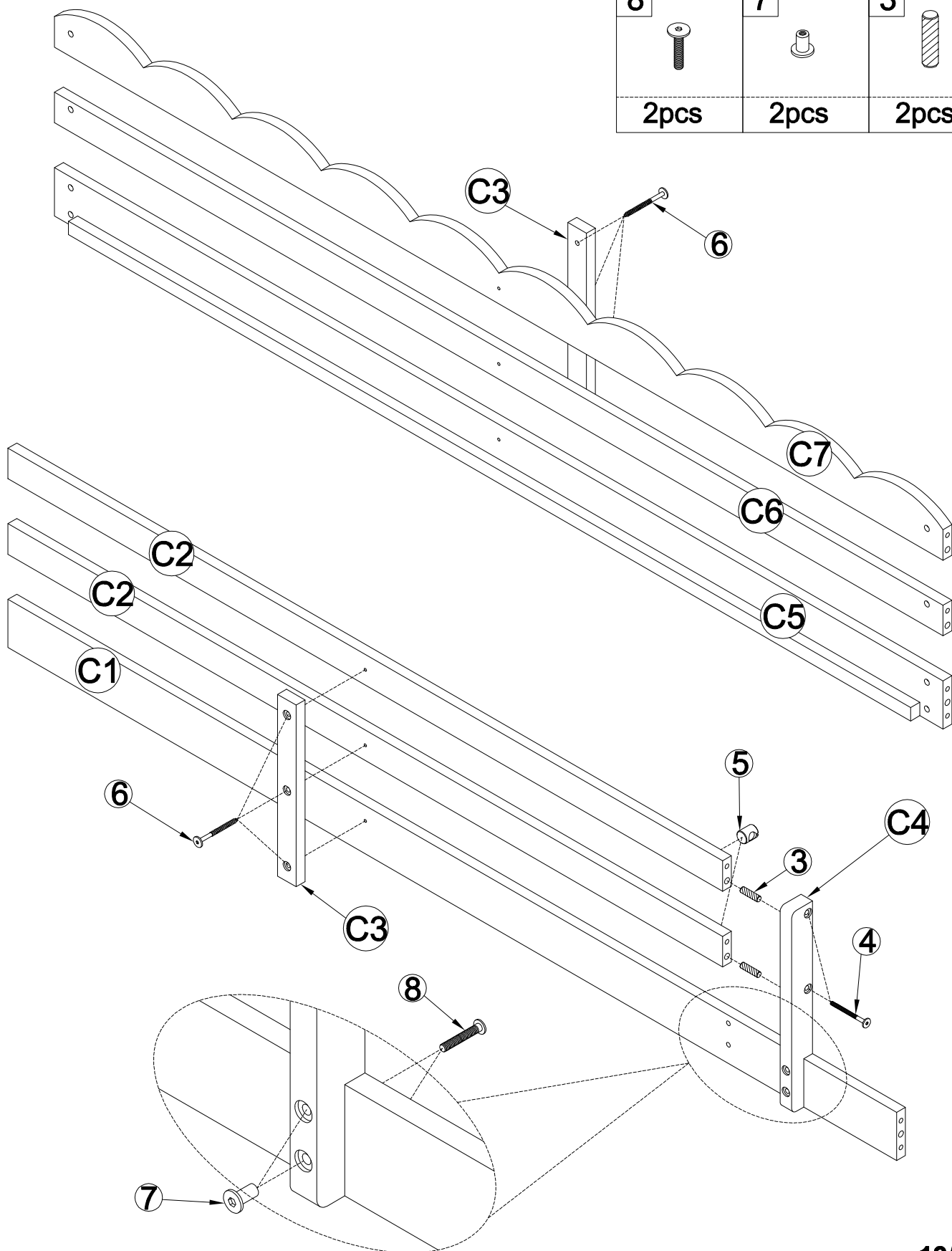

STEP 4: Following below illustration:

5	4	6
		
2pcs	2pcs	6pcs
8	7	3
		
2pcs	2pcs	2pcs

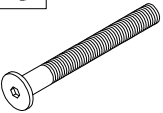

STEP 5: Following below illustration:

- Using hardward #5,#9 and dowel 3 to Assembly Frames (Completed on step 4) With Frames (Completed on step 1.2,step 2.2)
- Look at detail view for more detail

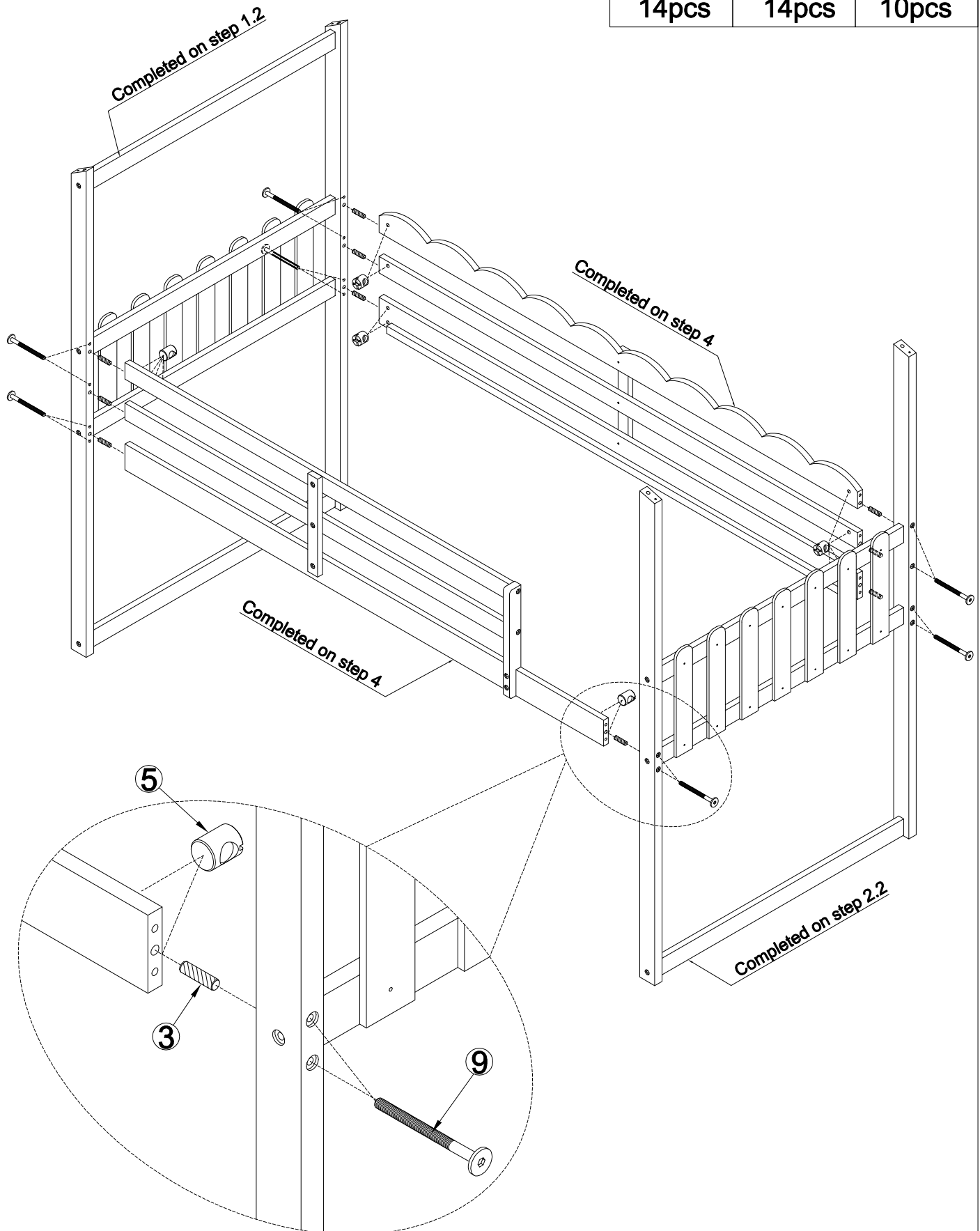

5	9	3
		
14pcs	14pcs	10pcs



STEP 6:

Following below illustration:

- Using hardward #10 and dowel 3 to Assembly Frames (Completed on step 5)
- With Frames (Completed on step 3)
- Look at detail view for more detail

10 	3 
4pcs	4pcs

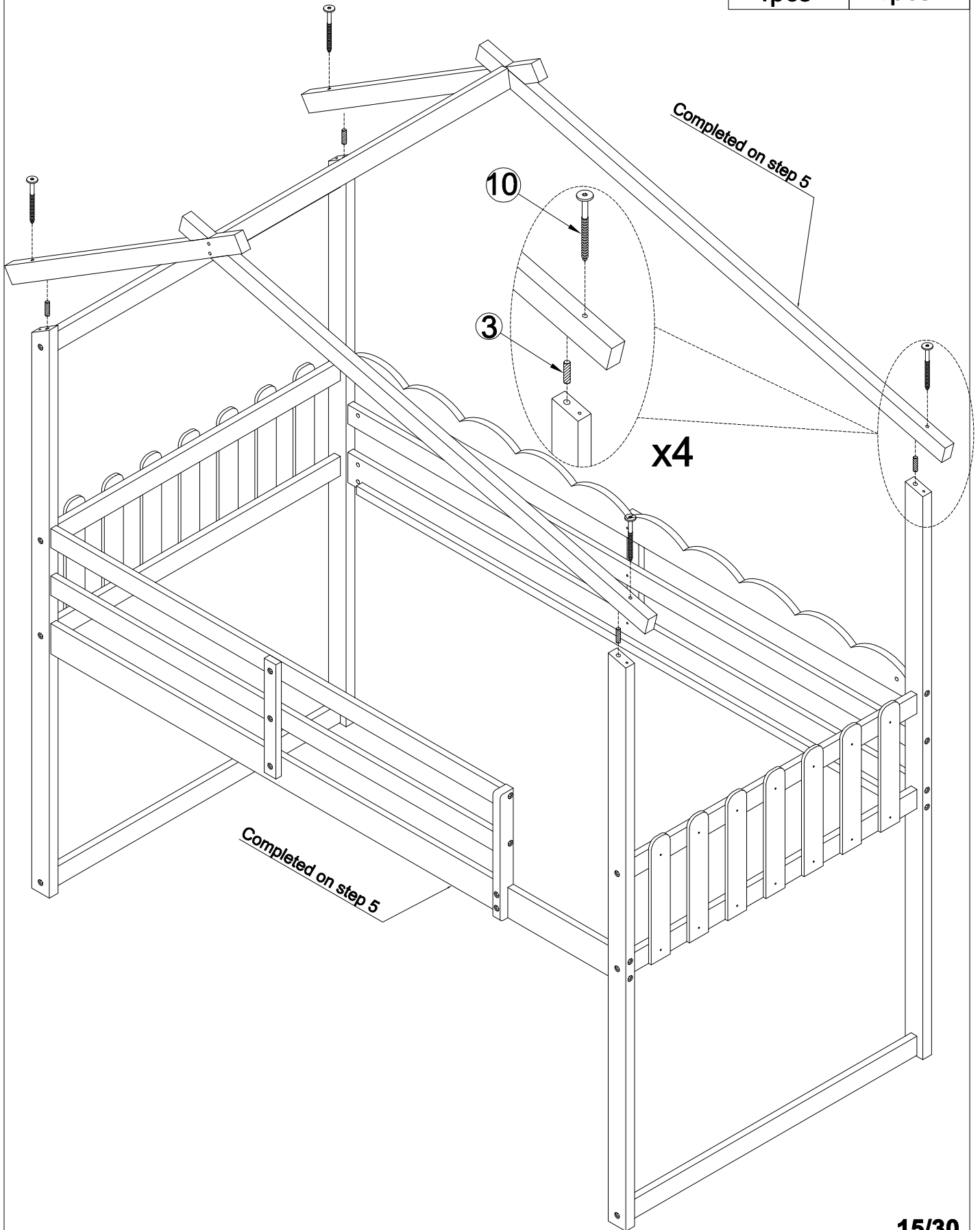

STEP 7: Following below illustration:

-Screw slats D5(x14) with Side Rail C1,C5 by using hardward #11.

11



28pcs

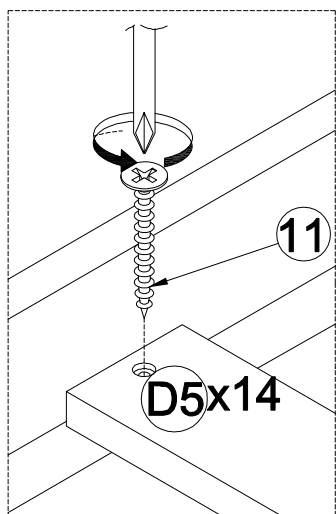
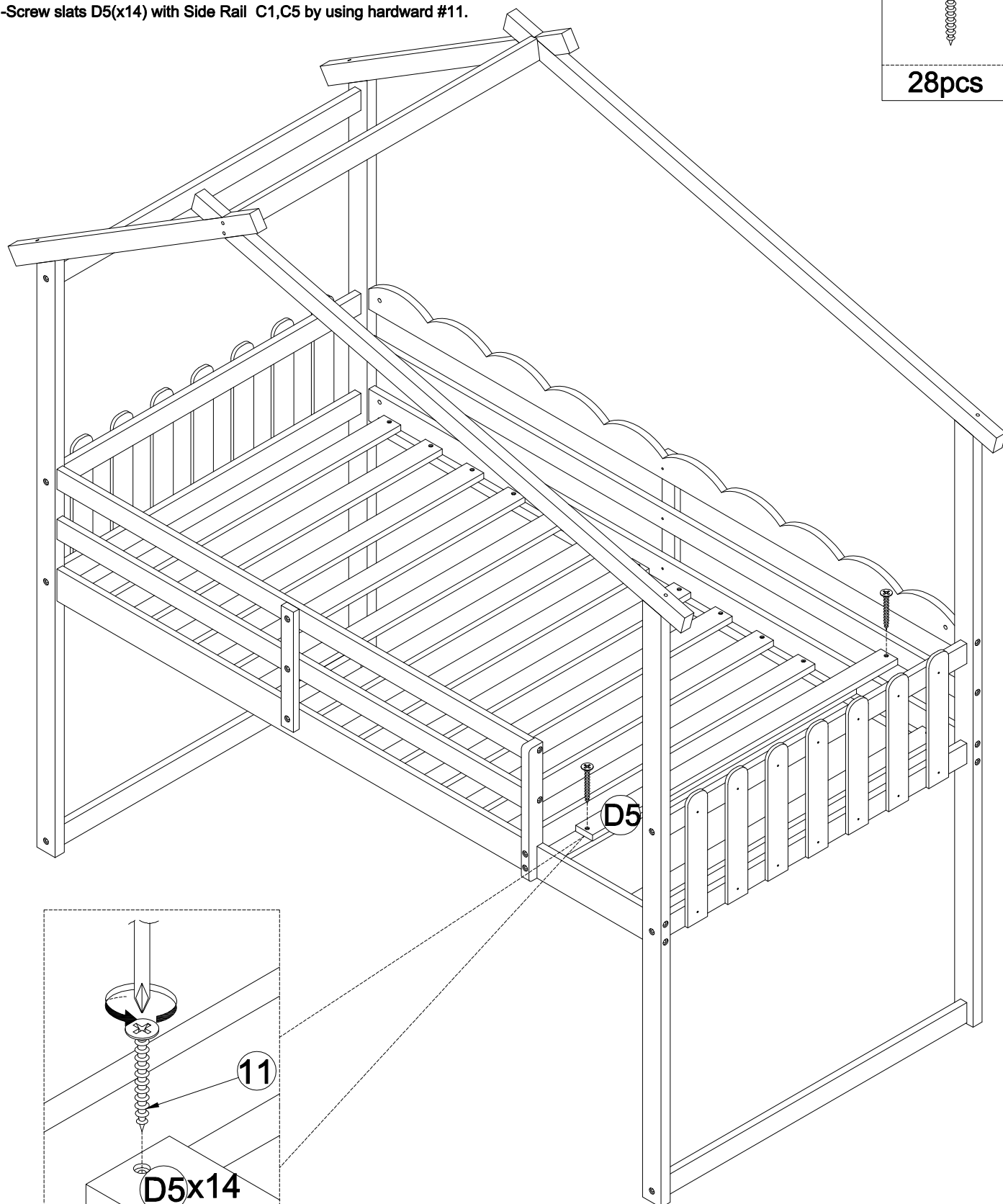

STEP 8:

Following below illustration:

- Using hardward #2 to Assembly Frames (Completed on step 7) With B5,B6
- Look at detail view for more detail

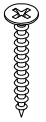

2

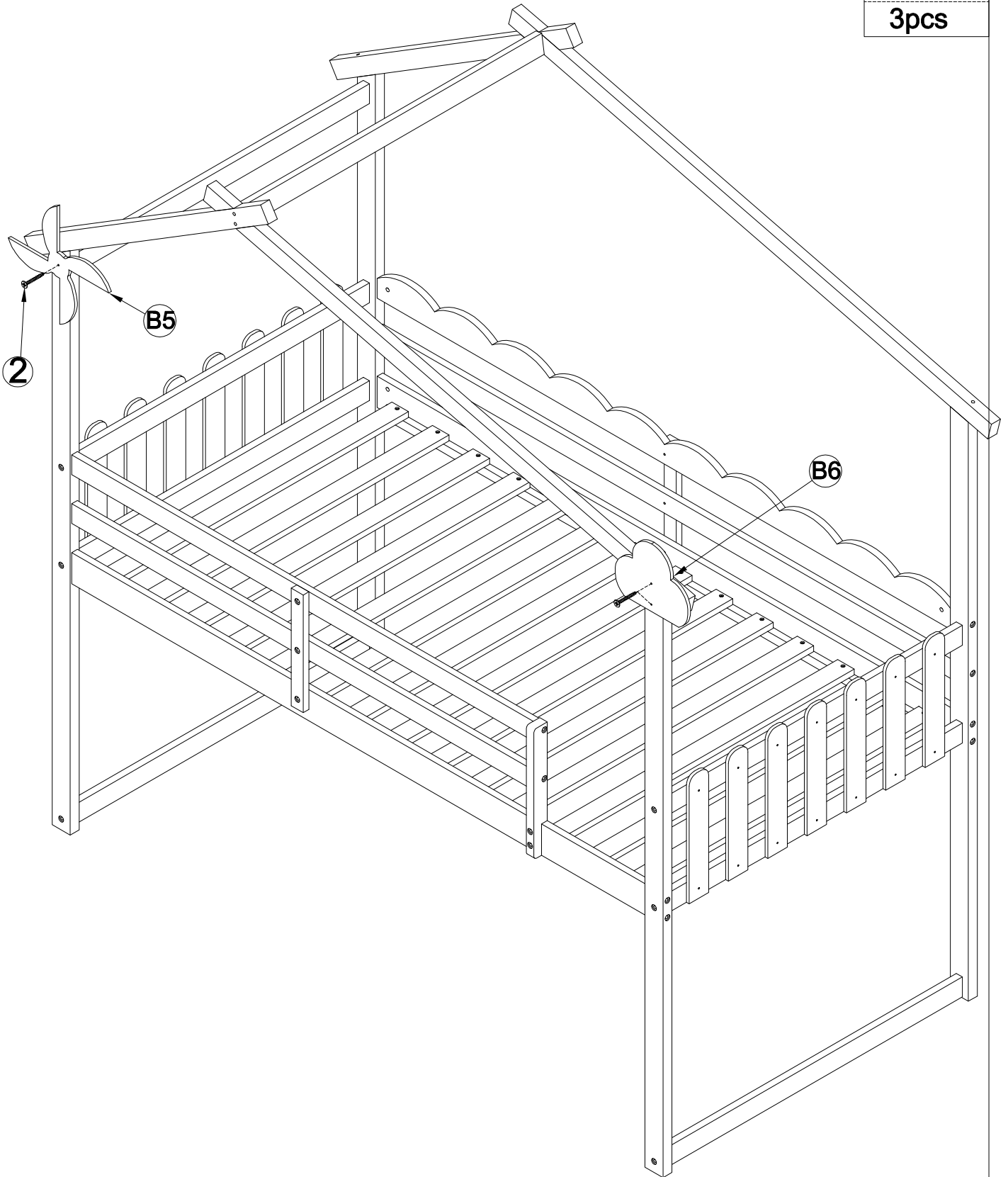

3pcs

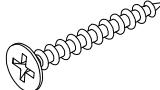

STEP 9: Following below illustration:

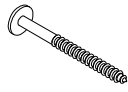
2 	12 	3 
4pcs	2pcs	12pcs
		1 
		6pcs

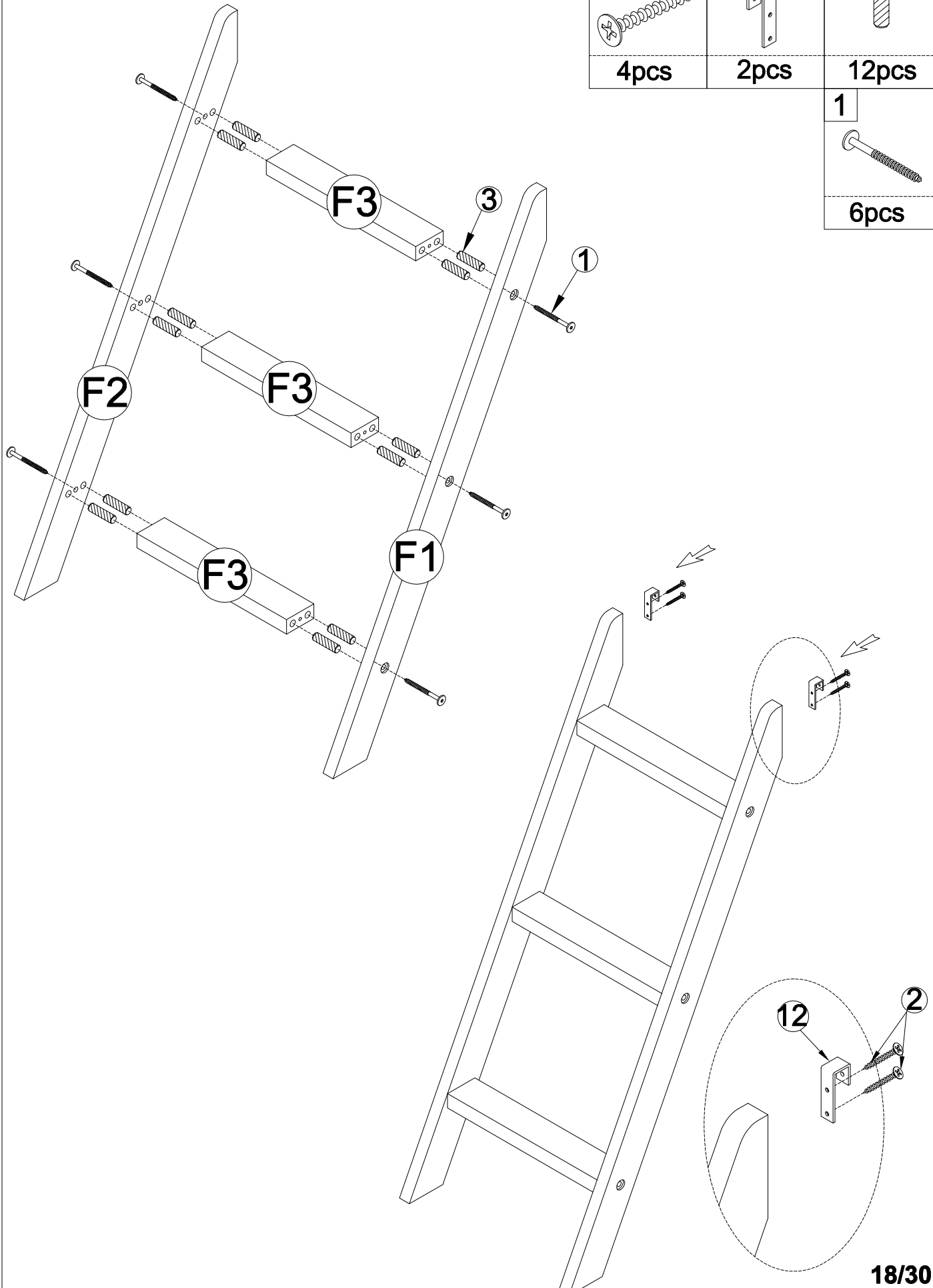

STEP 10: Following below illustration:

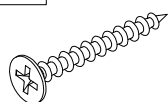
2

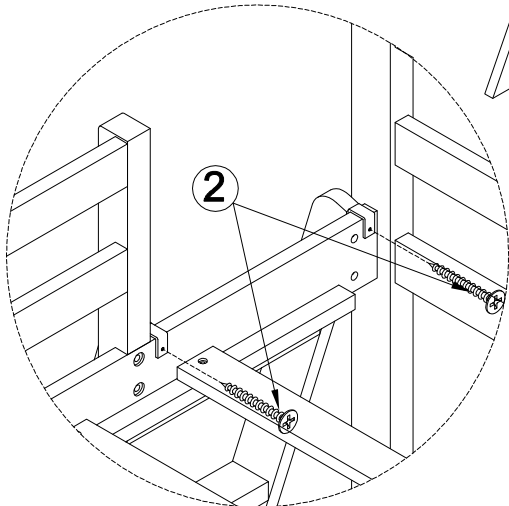
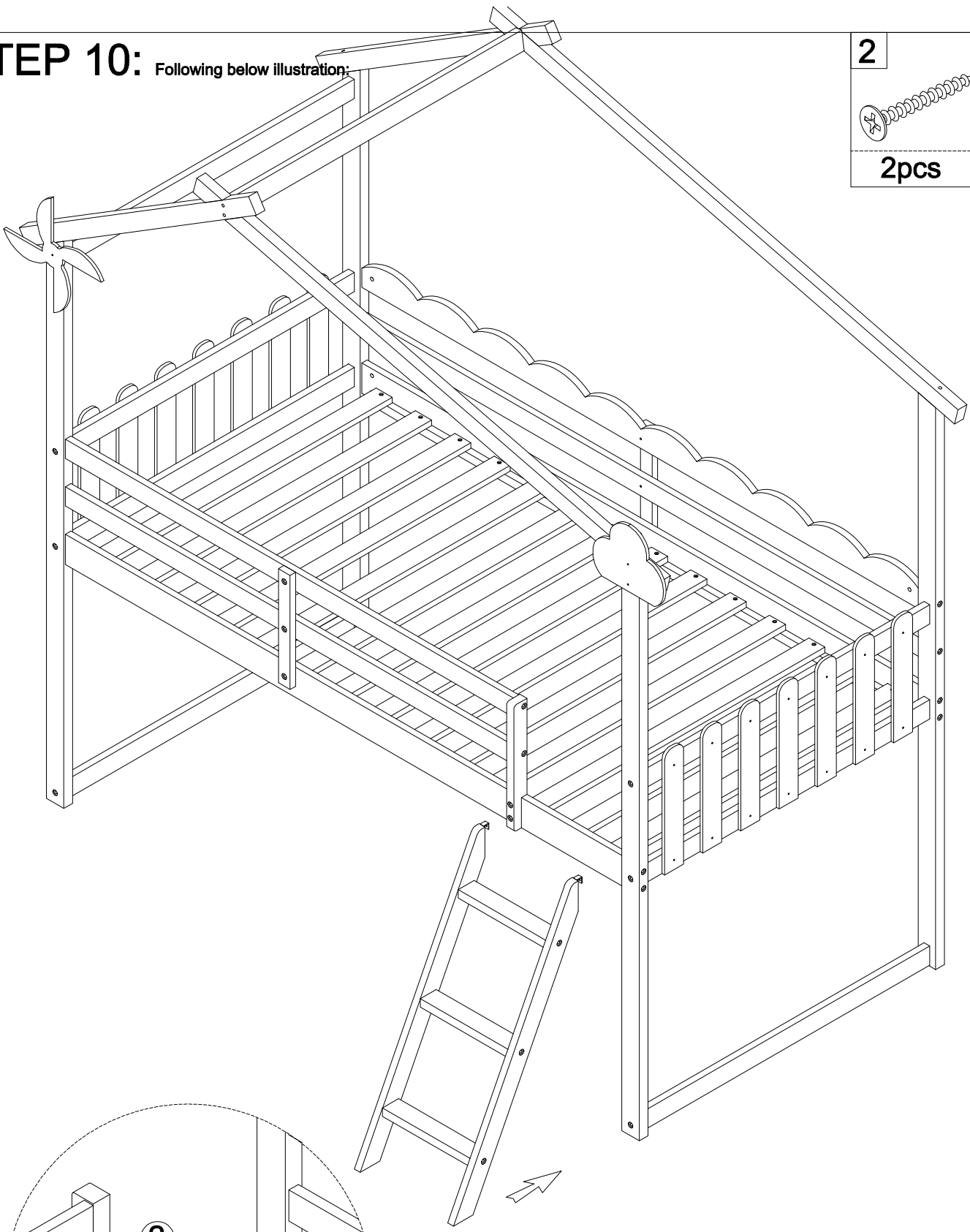
2pcs

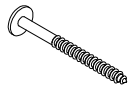

Inside View

STEP 11-1:

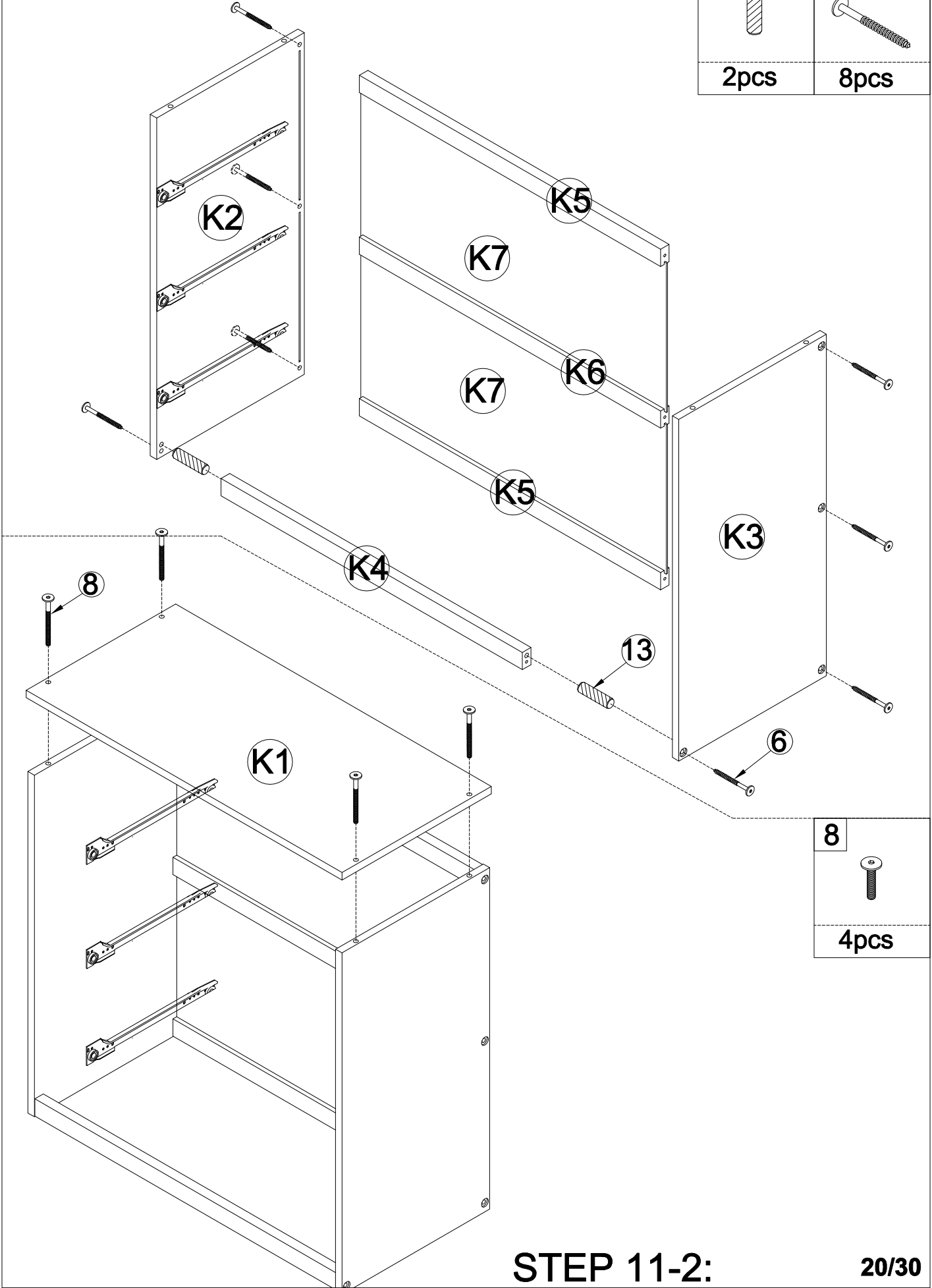

13		6	
2pcs		8pcs	



8	
4pcs	

STEP 11-2:

STEP 11-3:

15	14
	
1x3pcs	1x3pcs

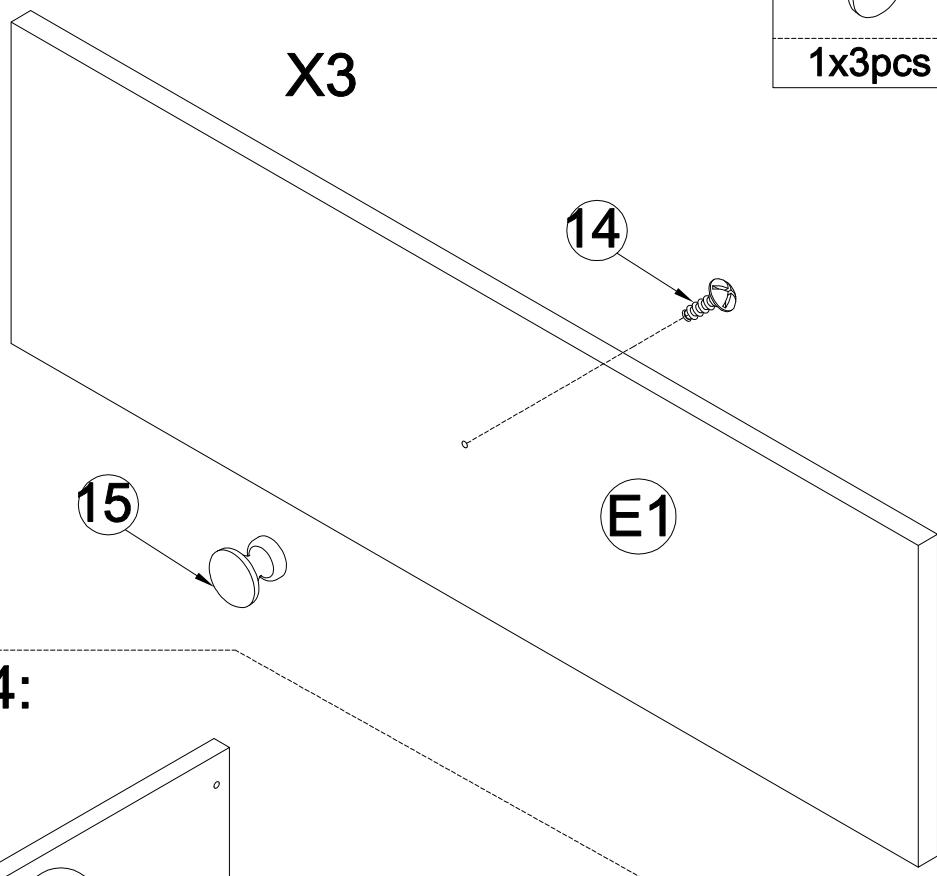

STEP 11-4:

11	
4x3pcs	

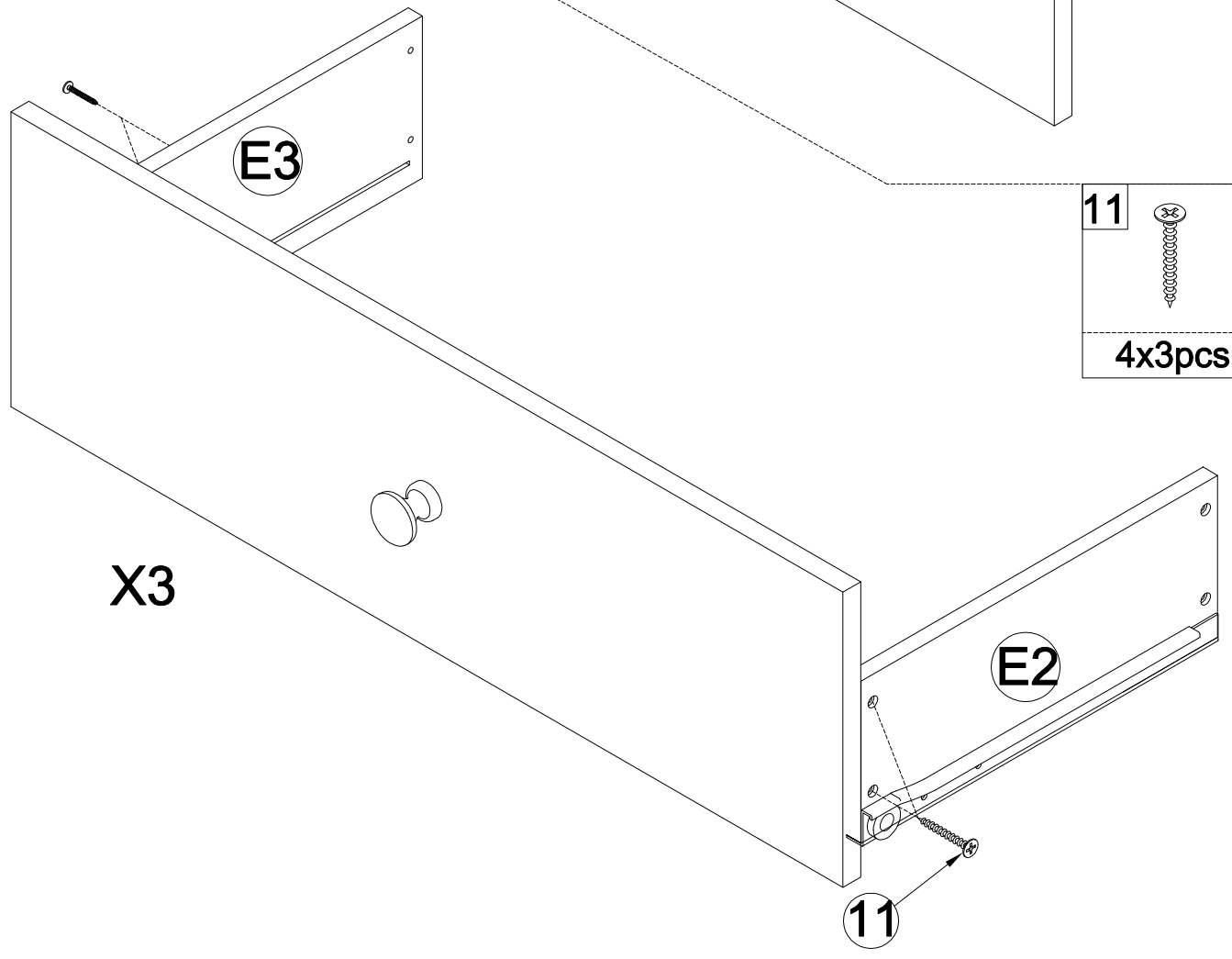

STEP 11-5:

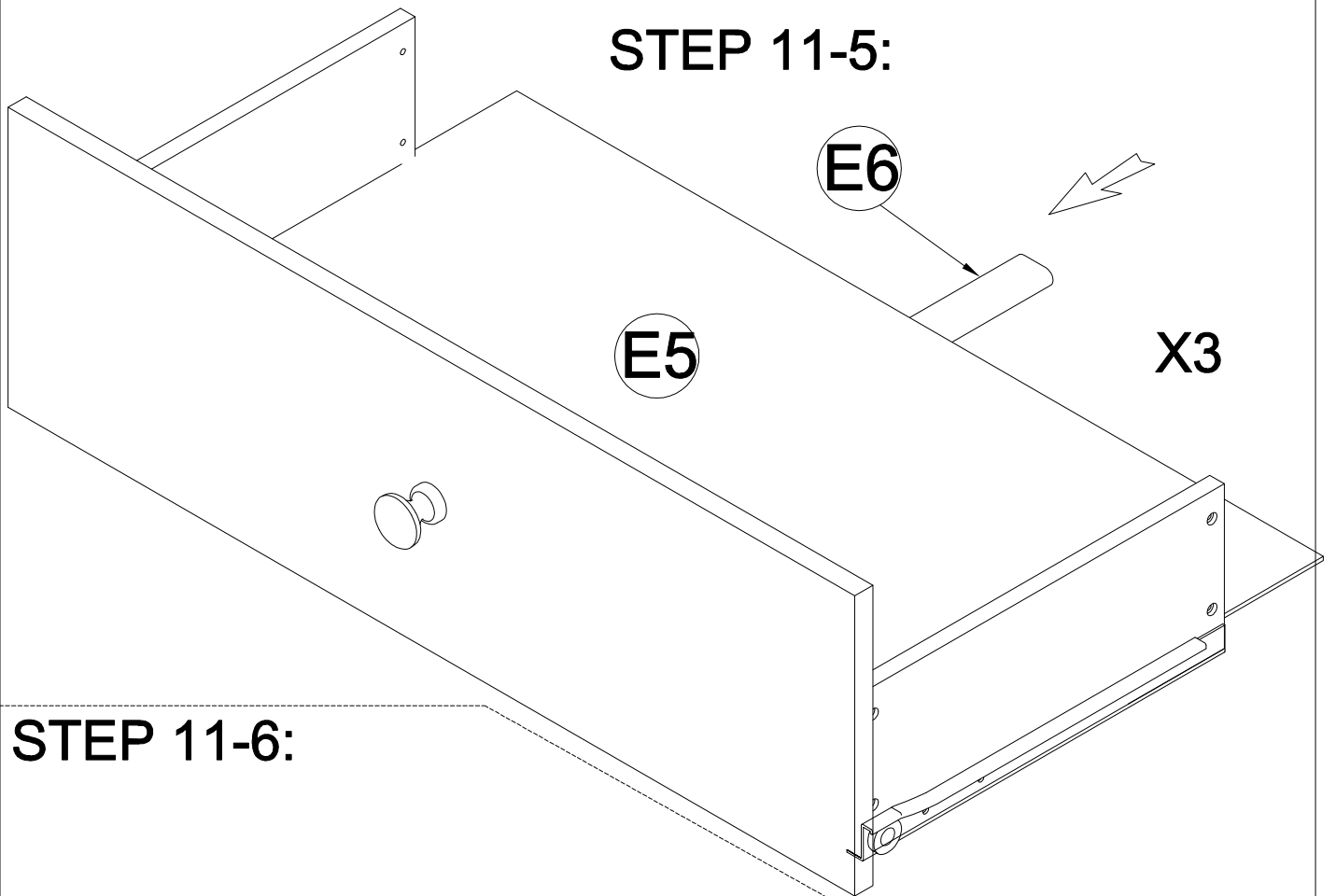

STEP 11-6:

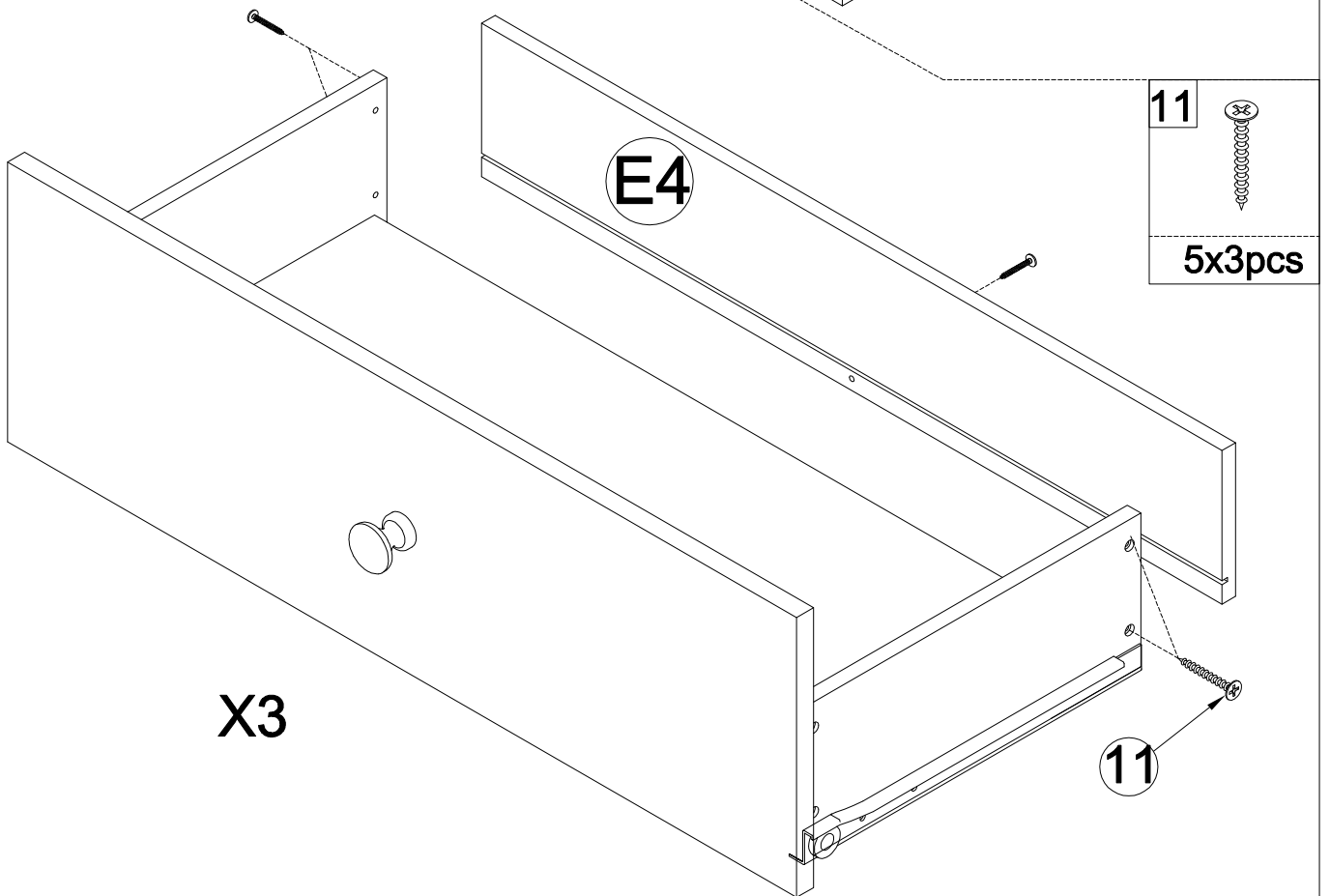

STEP 11-7:

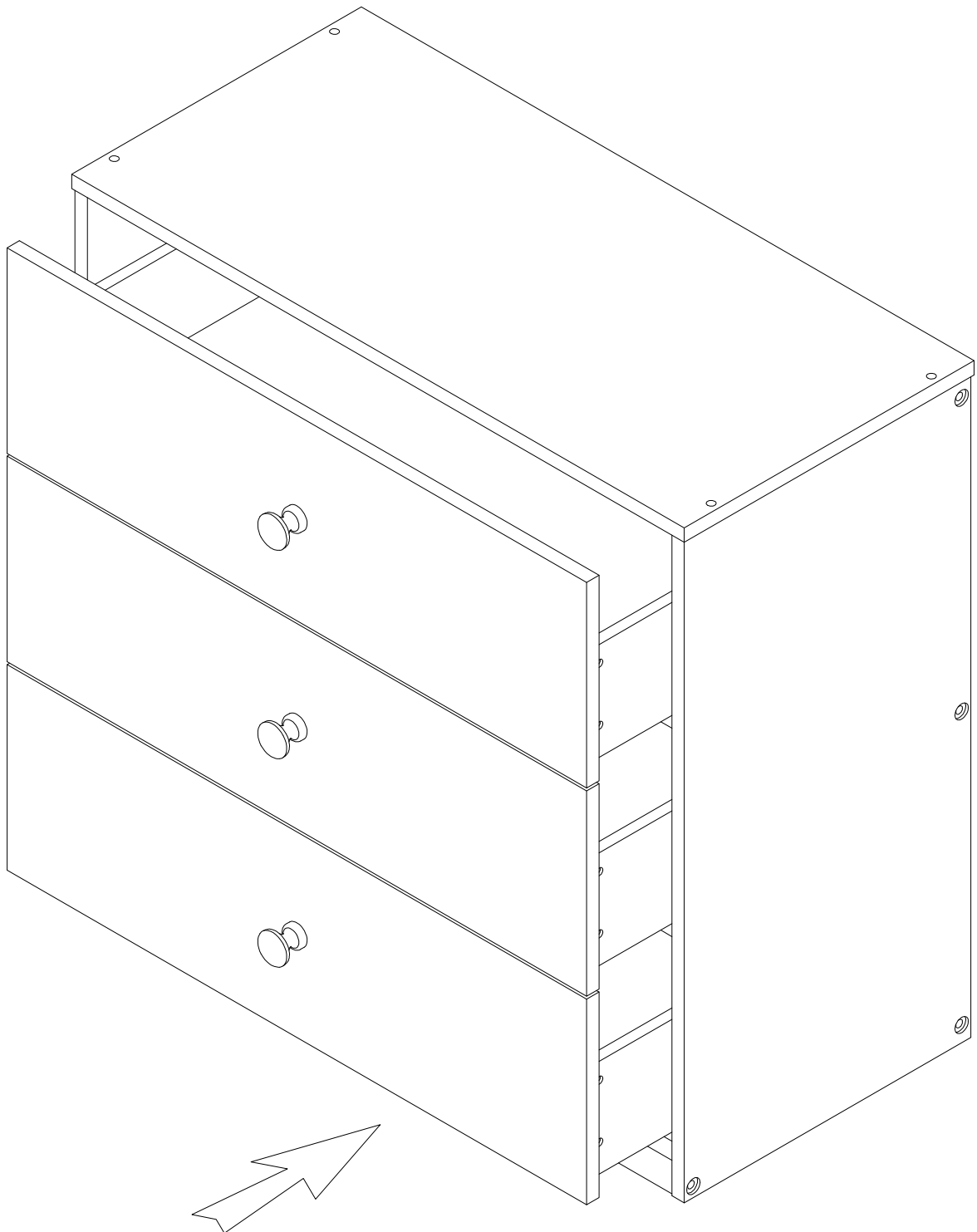

STEP 12-1:

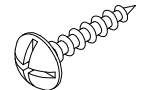
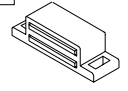
17 	16 
4pcs	2pcs

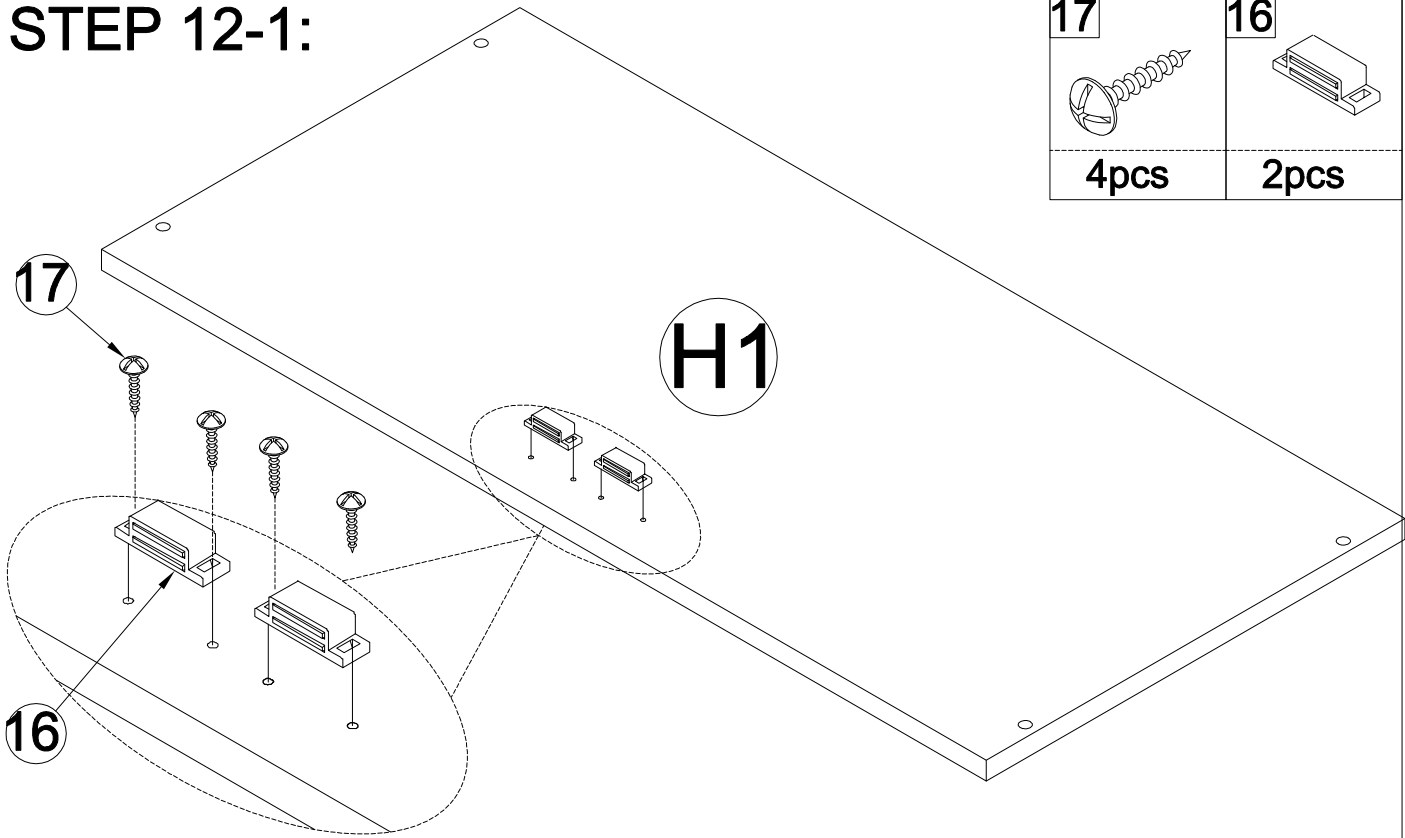

STEP 12-2:

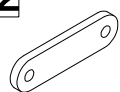
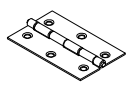
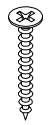
22 	19 	18 
2pcs	4pcs	16pcs

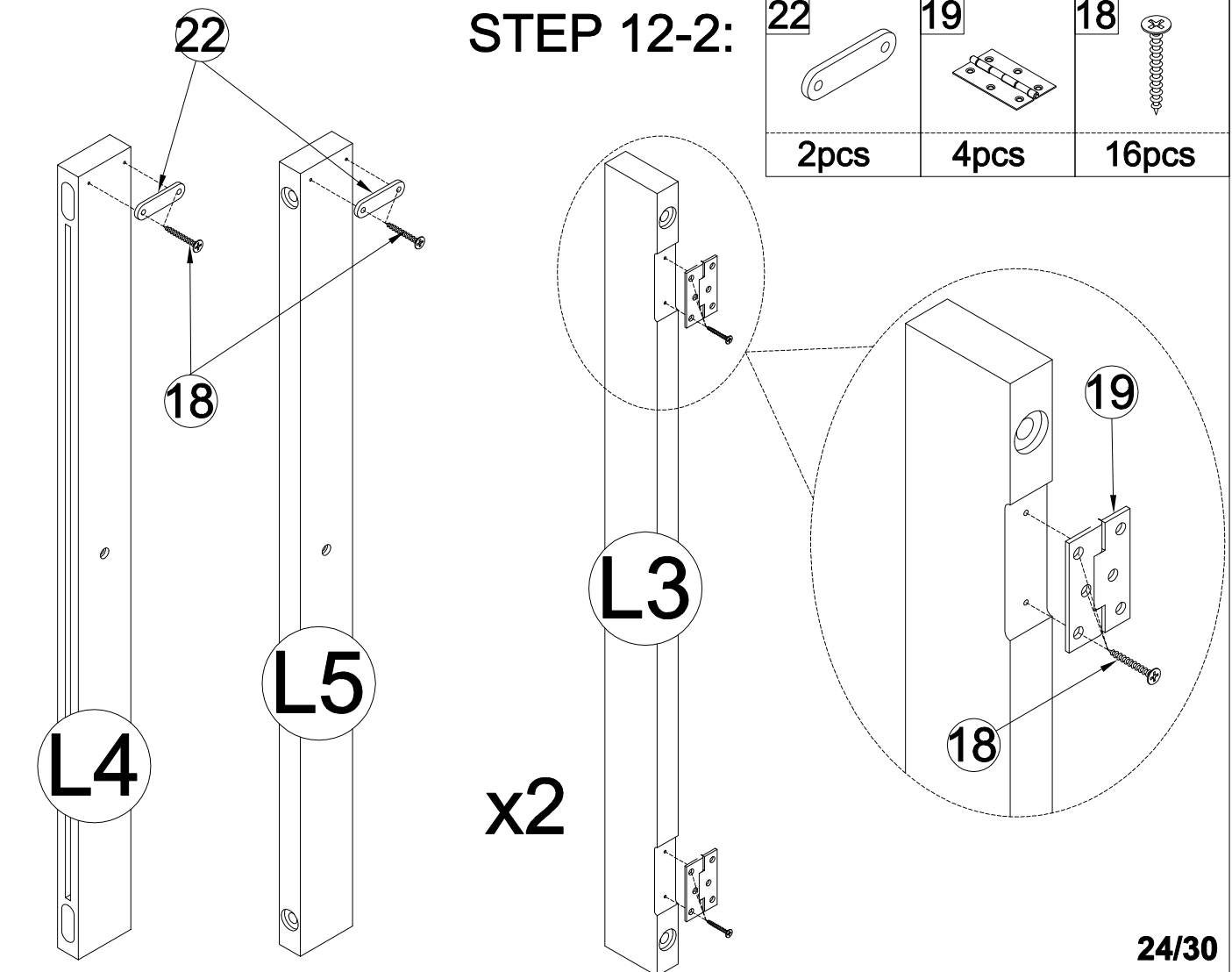

STEP 12-3:

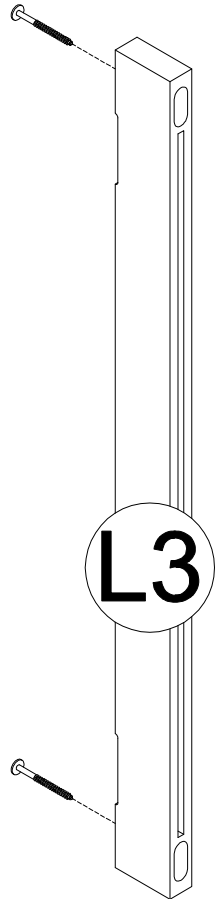

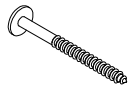

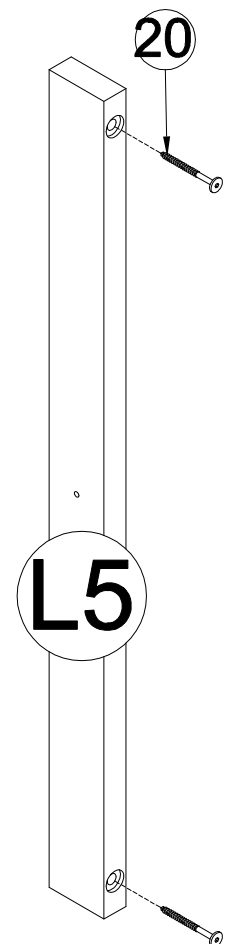
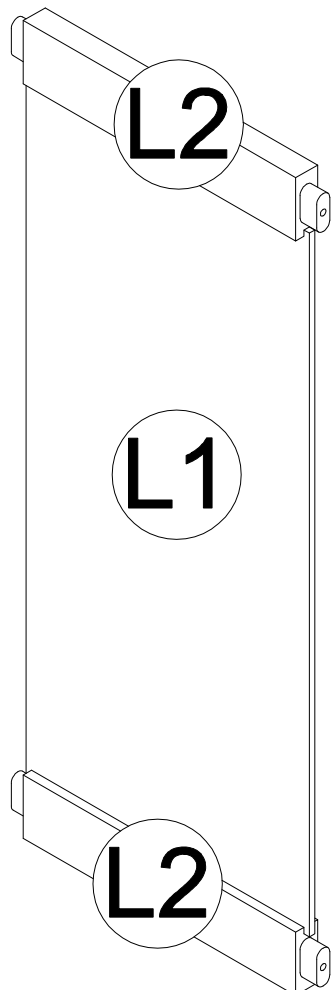
20

4pcs

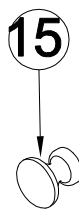
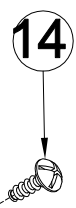
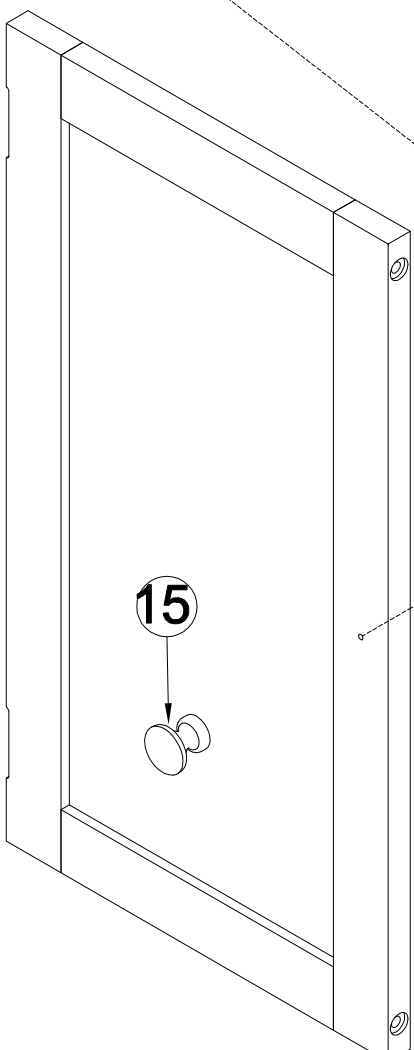



STEP 12-4:

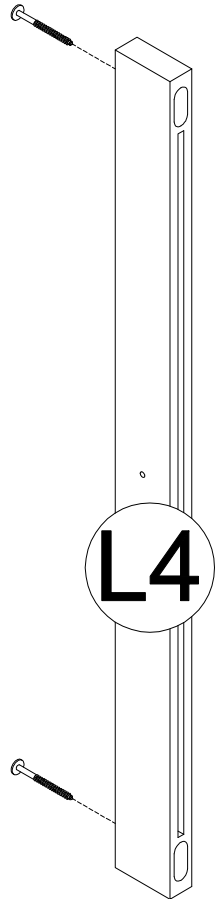

15	14
	
1pc	1pc

STEP 12-5:



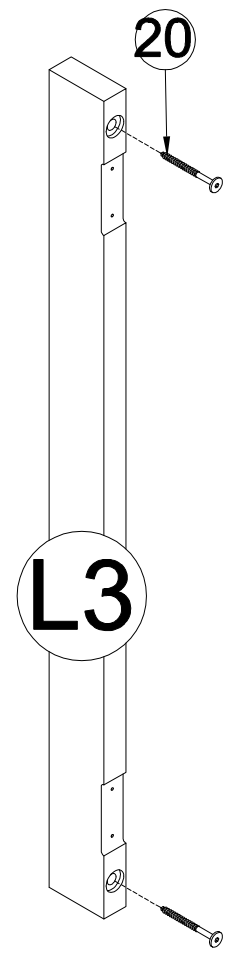
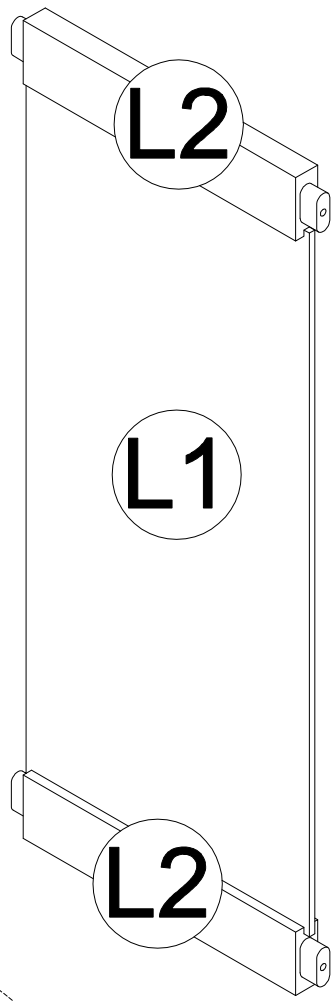

20

4pcs

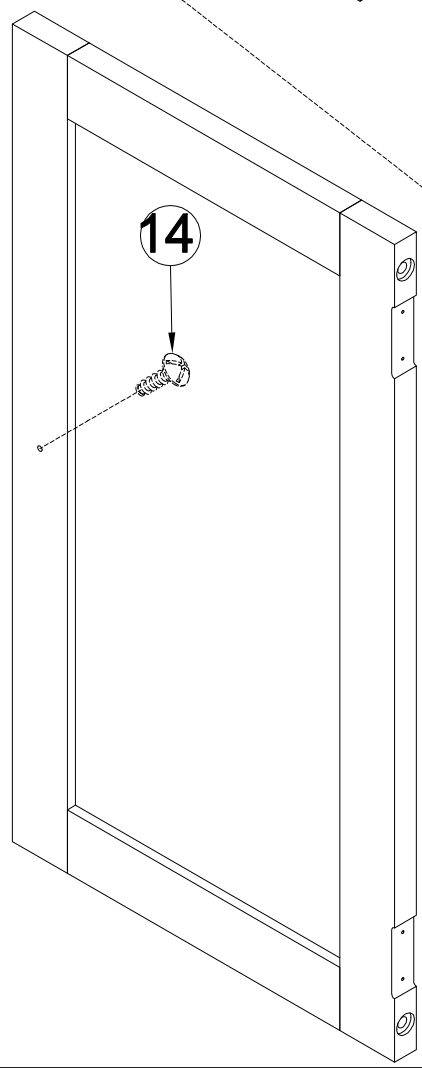
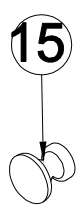

STEP 12-6:



15	14
	
1pc	1pc

STEP 12-7:

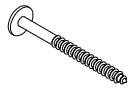
13		6	
2pcs		8pcs	

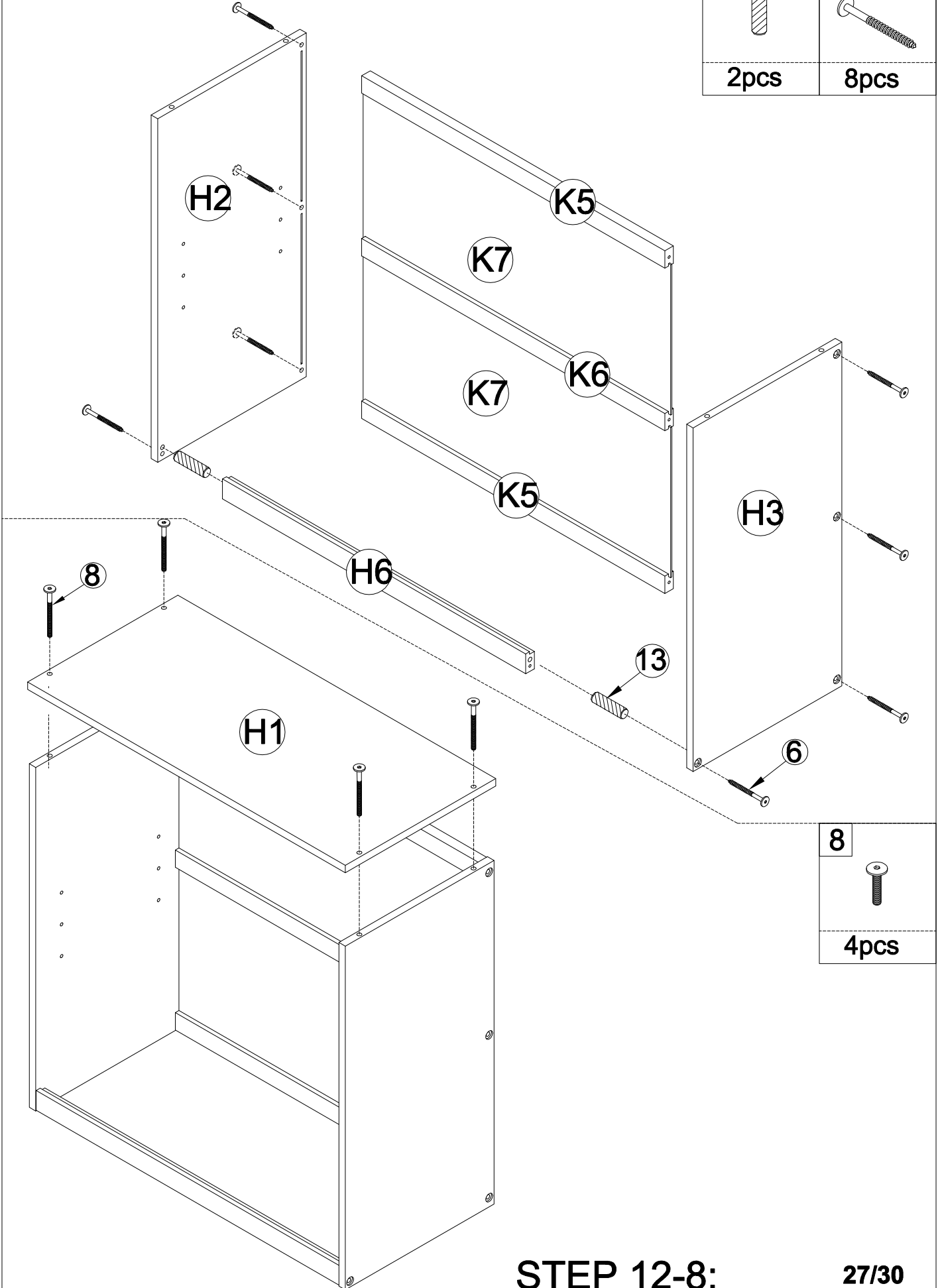

8	
4pcs	

STEP 12-8:

STEP 12-9:

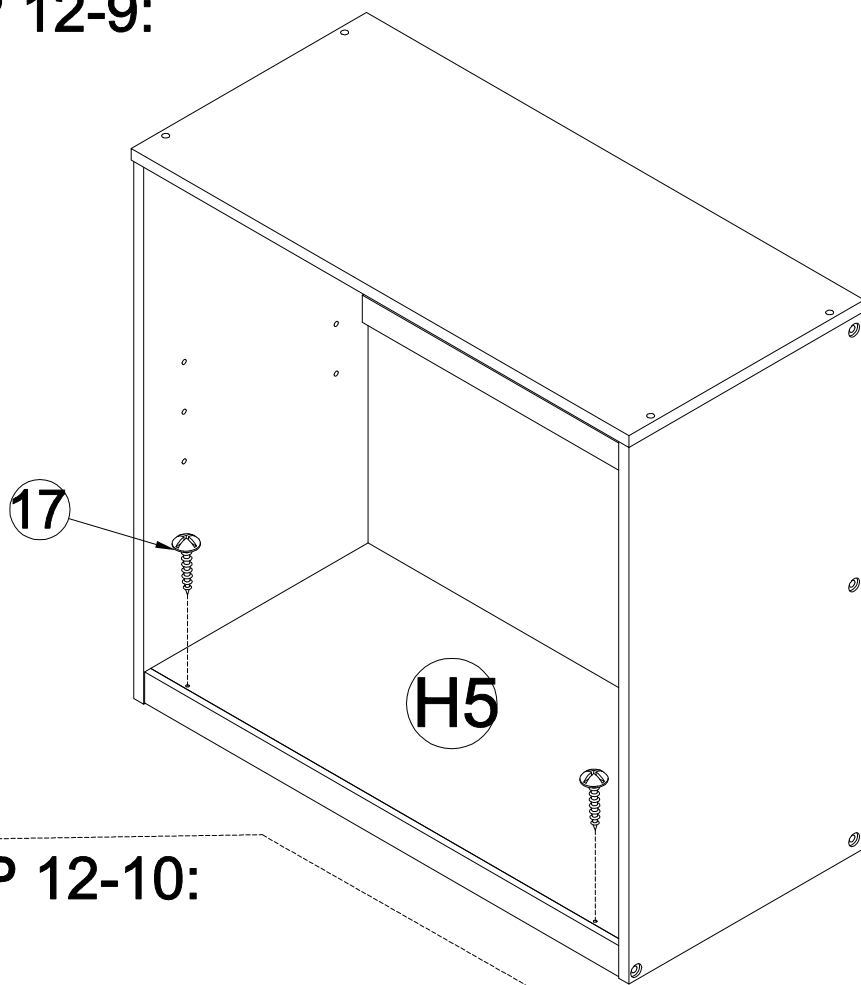

17

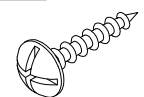

2pcs

STEP 12-10:

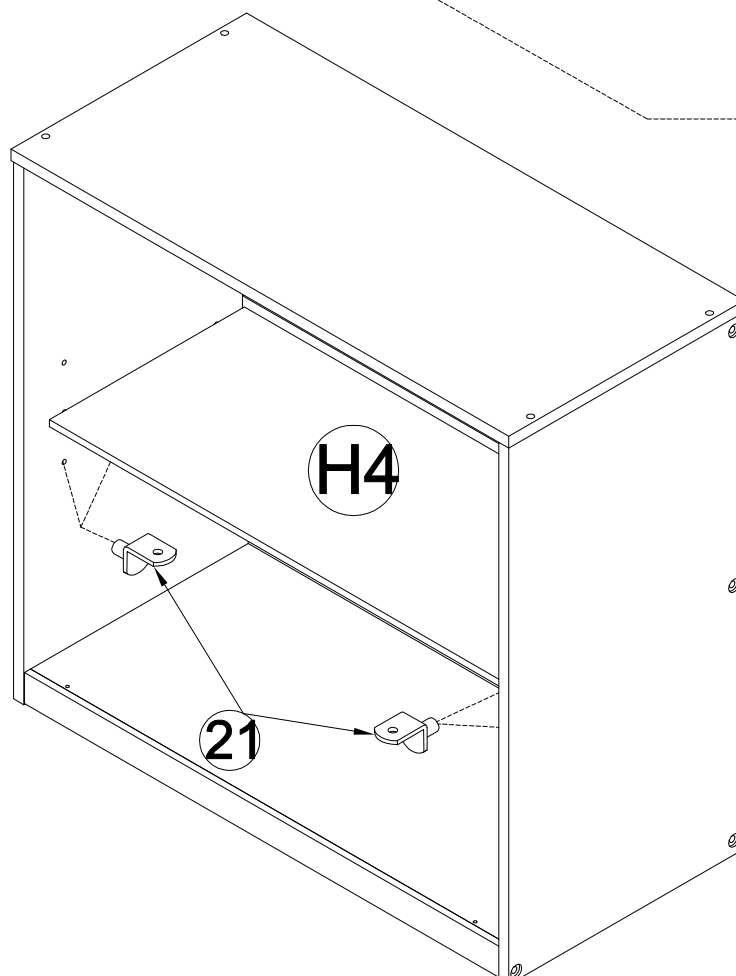

21



4pcs

STEP 12-11:

18



12pcs

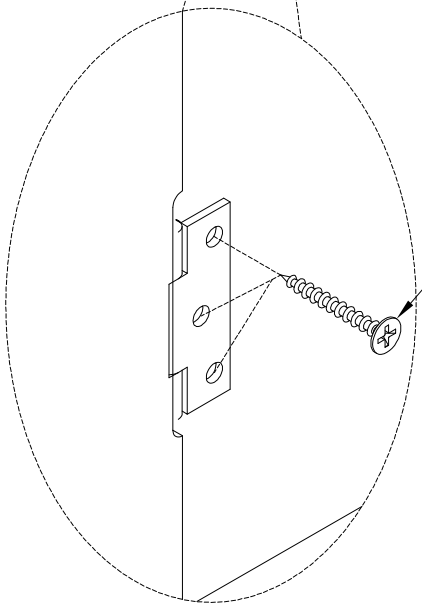
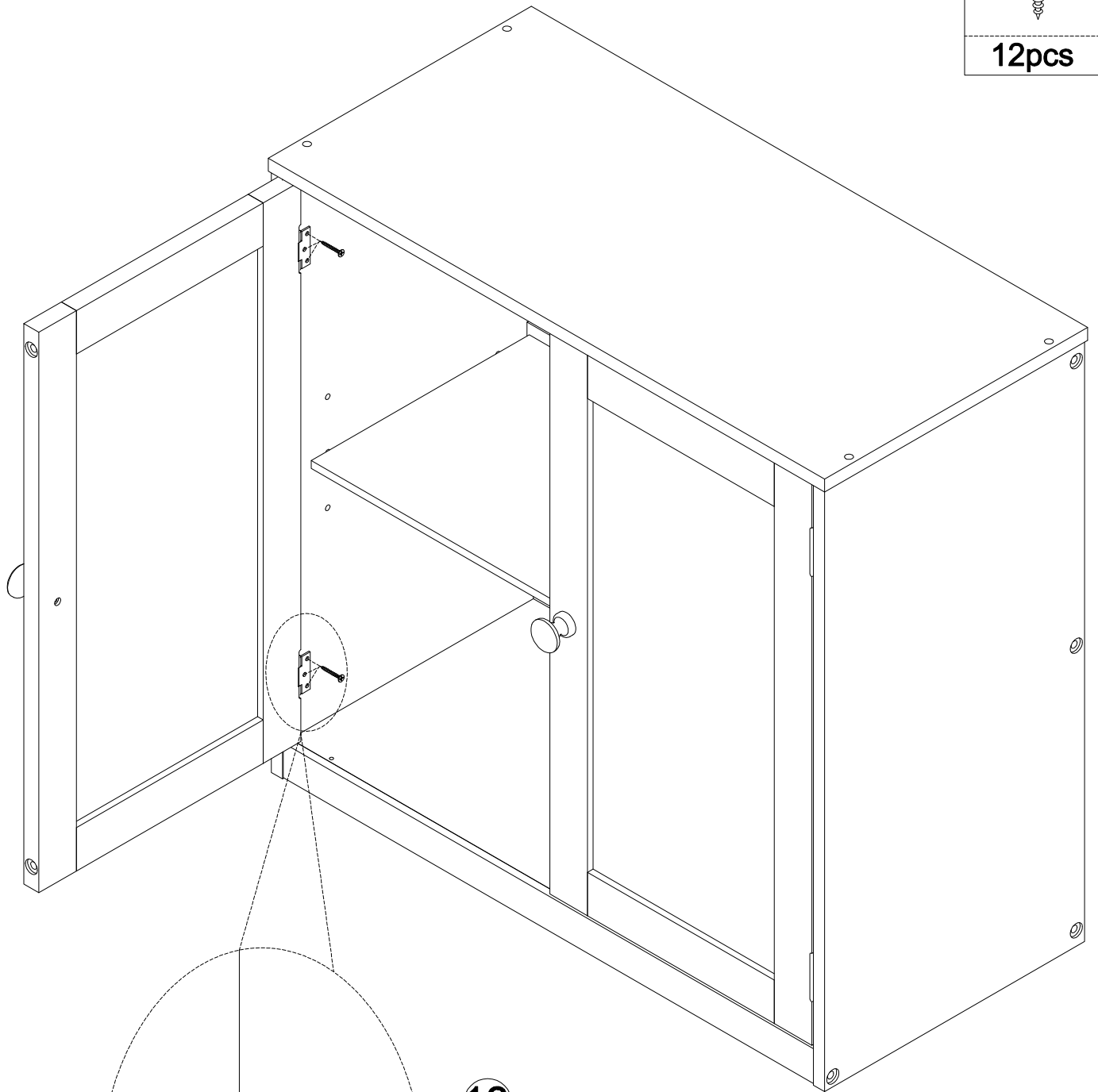

18

X4

CONGRARULATION. YOU HAVE COMPLETED THE BED
Push 2 Chest on right place

