

ASSEMBLY INSTRUCTION

BED HOUSE WITH TRUNDLE

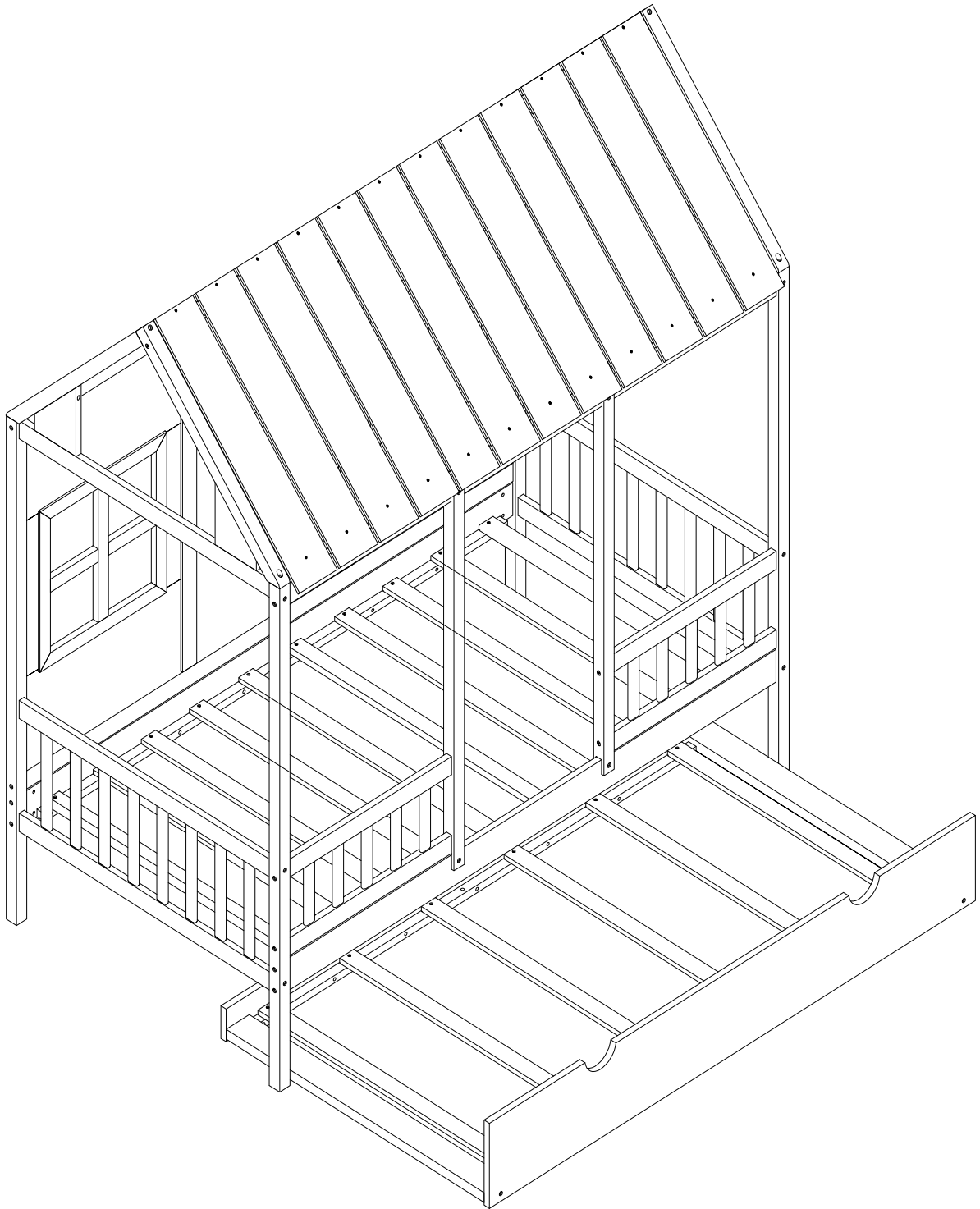







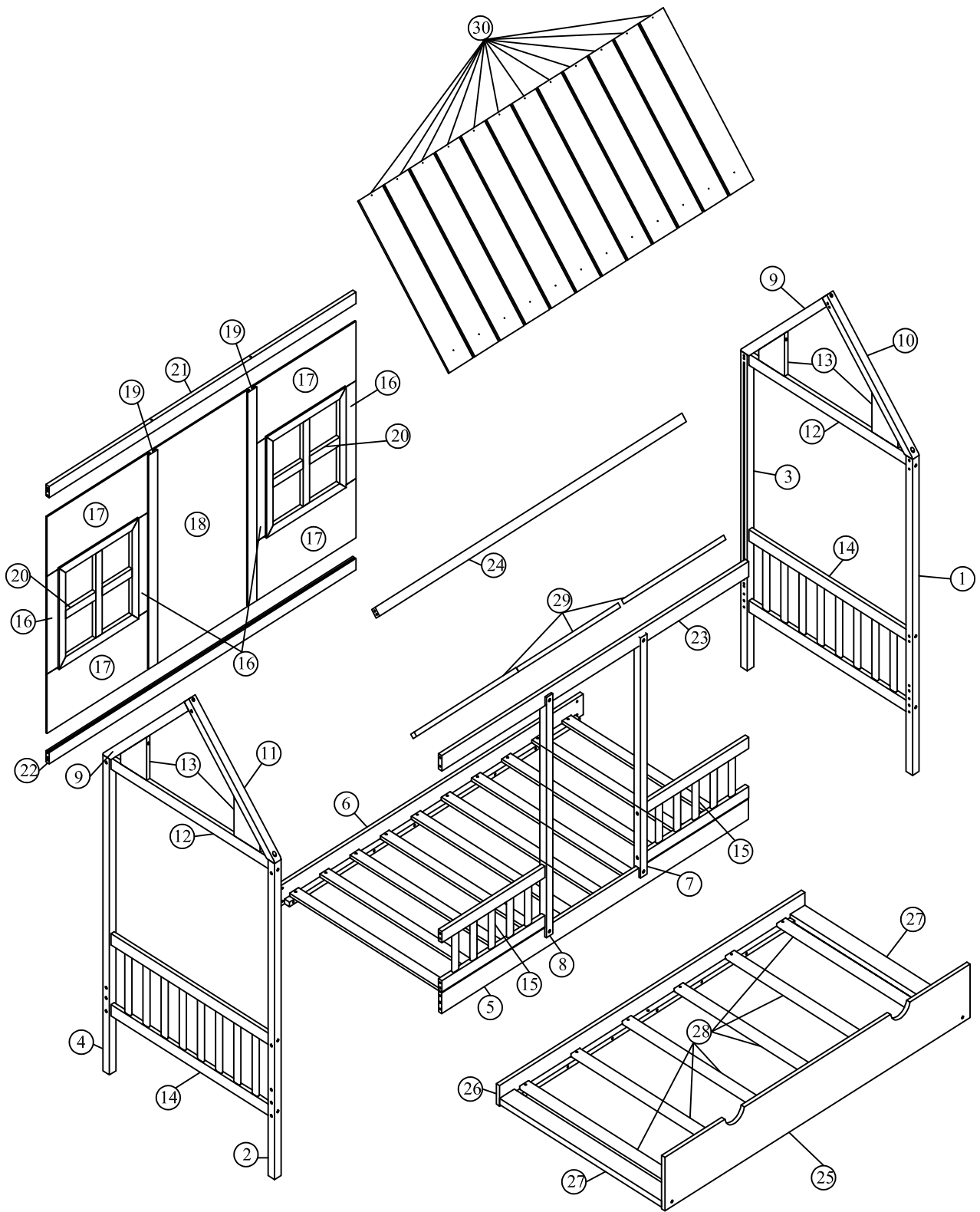



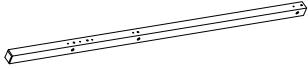
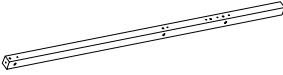

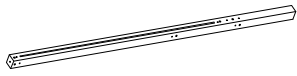

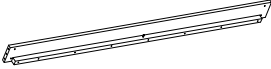
This set included 2 boxes if don't receive full 2 boxes please contact our customer service team.

WF304131/32







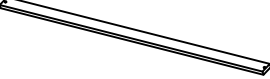







Detail view:



Part List (WF304132)

1	 Leg front right - 1pc	2	 Leg front left - 1pc	3	 Leg back right - 1pc
4	 Leg back left - 1pc	5	 Front bed shoulder - 1pc	6	 Back bed shoulder - 1pc
7	 Quiz standing front right - 1pc	8	 Quiz standing front left - 1pc	9	 Right left rear roof - 2pcs
21	 Crossbar upper back - 1pc	22	 Crossbar lower back - 1pc	23	 Crossbar lower front - 1pc
24	 Qui across the roof - 1pc	25	 Drawer panels - 1pc	26	 Backboard pull drawer - 1pc
27	 Drawer horizontal bar - 2pcs	28	 Slat - 16pcs		





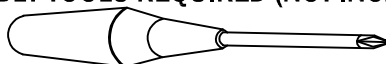

Hardware List

A	 Ø10*20mm Wood dowel (58pcs)	B	 M6*88mm (Ø15) Hex - Head bolt (8pcs)	C	 M6 Horizontal - Hole bolt (8pcs)
D	 M6*60mm (Ø15) Hex - Head bolt (30pcs)	E	 M6*35mm (Ø15) Hex - Head bolt (10pcs)	G	 M6*15mm (Ø15) Hex - Head bolt (4pcs)
I	 Wheel (4pcs)	J	 100*60*2mm Metal Plate (1pc)	K	 #4*50mm Screw (8pcs)
L	 #4*35mm Screw (4pcs)	M	 #4*25mm Screw (56pcs)	N	 #4*20mm Screw (8pcs)
O	 K4mm Allen key (1pc)	P	 M8*30-Ø25*10mm Leveler (2pcs)		

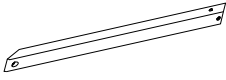
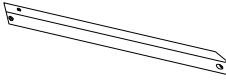
ASSEMBLY TOOLS REQUIRED (NOT INCLUDED)

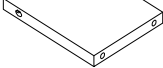
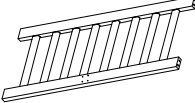
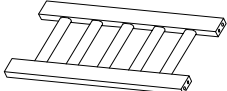

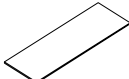
Part List (WF304131)

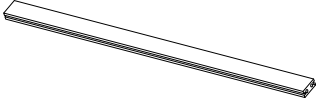
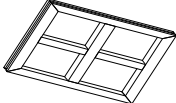
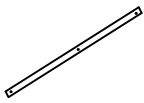
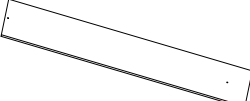
<p>10</p>  <p>Quiz the roof right front- 1pc</p>	<p>11</p>  <p>Quiz the roof left front - 1pc</p>	<p>12</p>  <p>Side frame top rail - 2pcs</p>
<p>13</p>  <p>Side frame decoration - 4pcs</p>	<p>14</p>  <p>Side frame - 2pcs</p>	<p>15</p>  <p>Front frame - 2pcs</p>
<p>16</p>  <p>Back panel 1 - 4pcs</p>	<p>17</p>  <p>Back panel 2 - 4pcs</p>	<p>18</p>  <p>Between Back panel - 1pc</p>
<p>19</p>  <p>Quiz standing back frame - 2pcs</p>	<p>20</p>  <p>Window frame - 2pcs</p>	<p>29</p>  <p>Roof board support bottom -3pcs</p>
<p>30</p>  <p>Roof panel - 12pcs</p>		

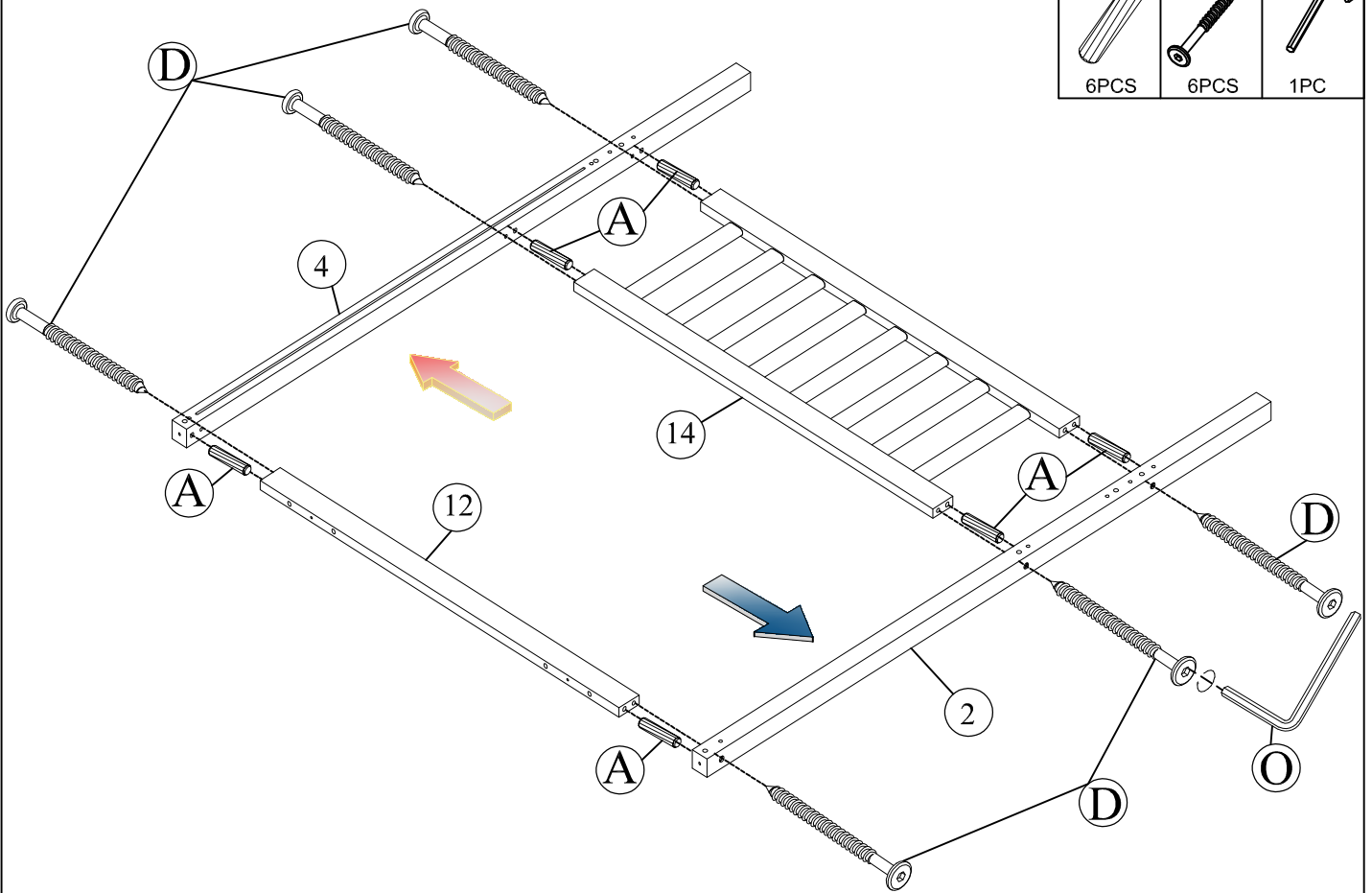

STEP 1:

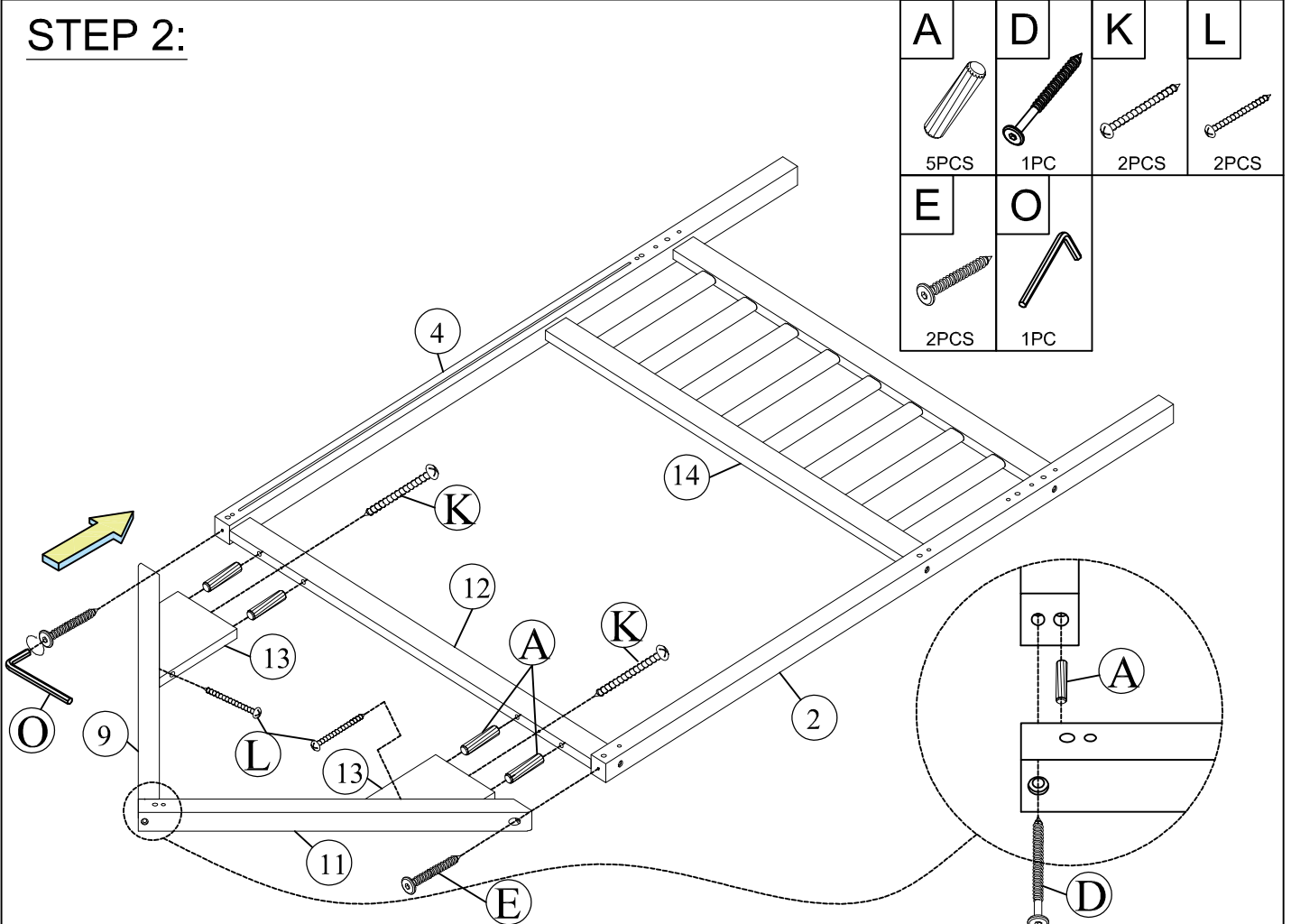

STEP 2:



STEP 5:



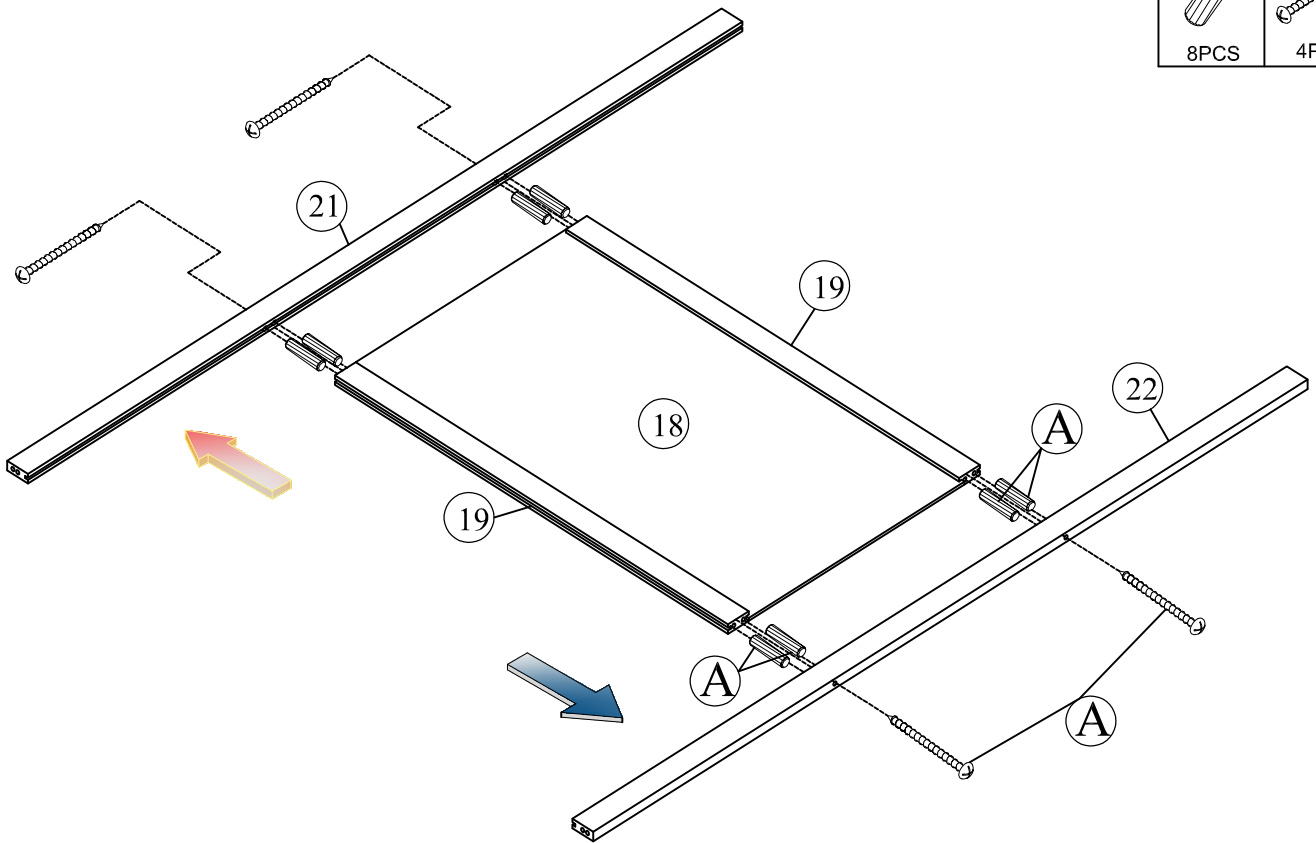

A	K
	
8PCS	4PCS

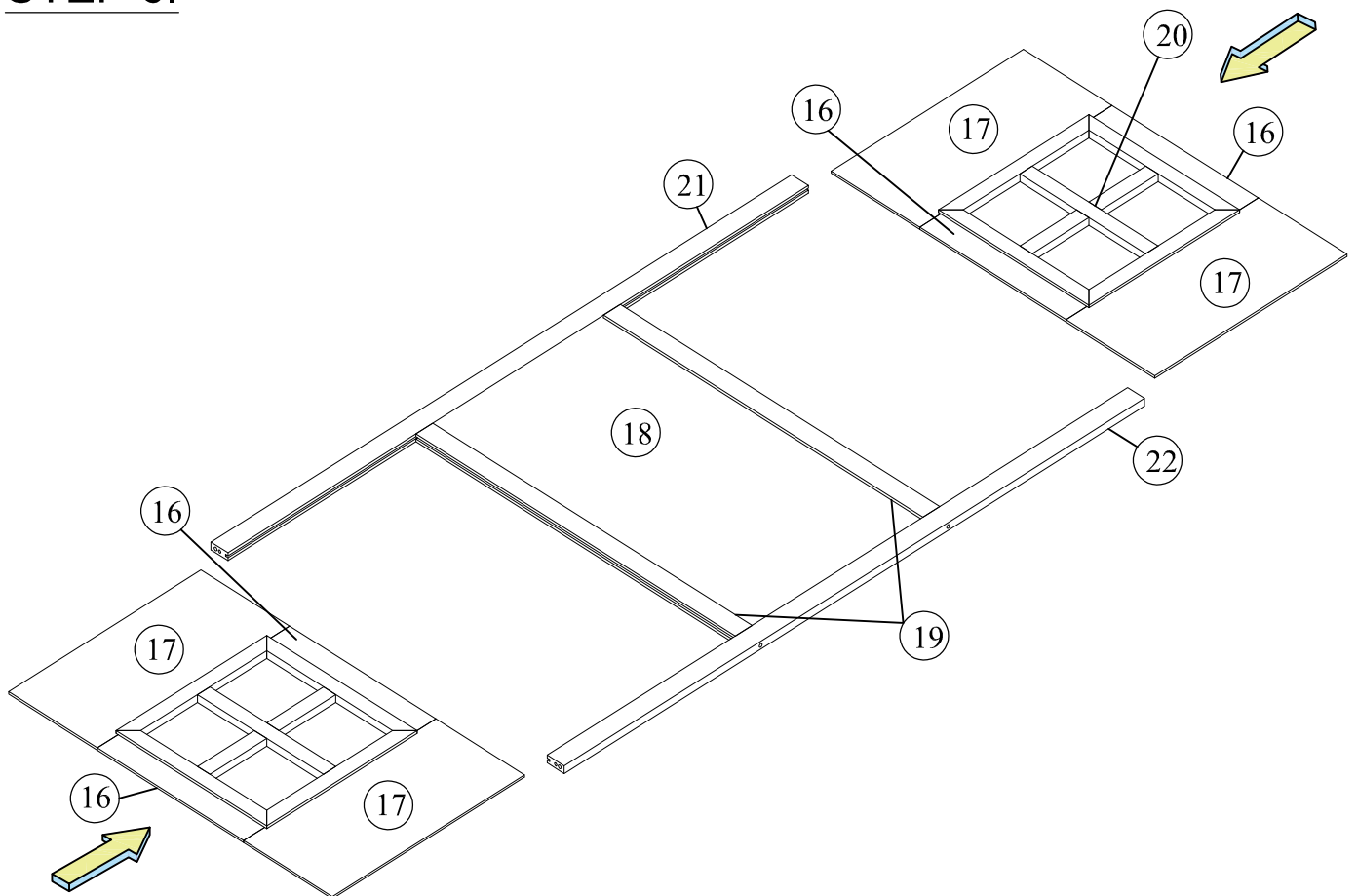

STEP 6:



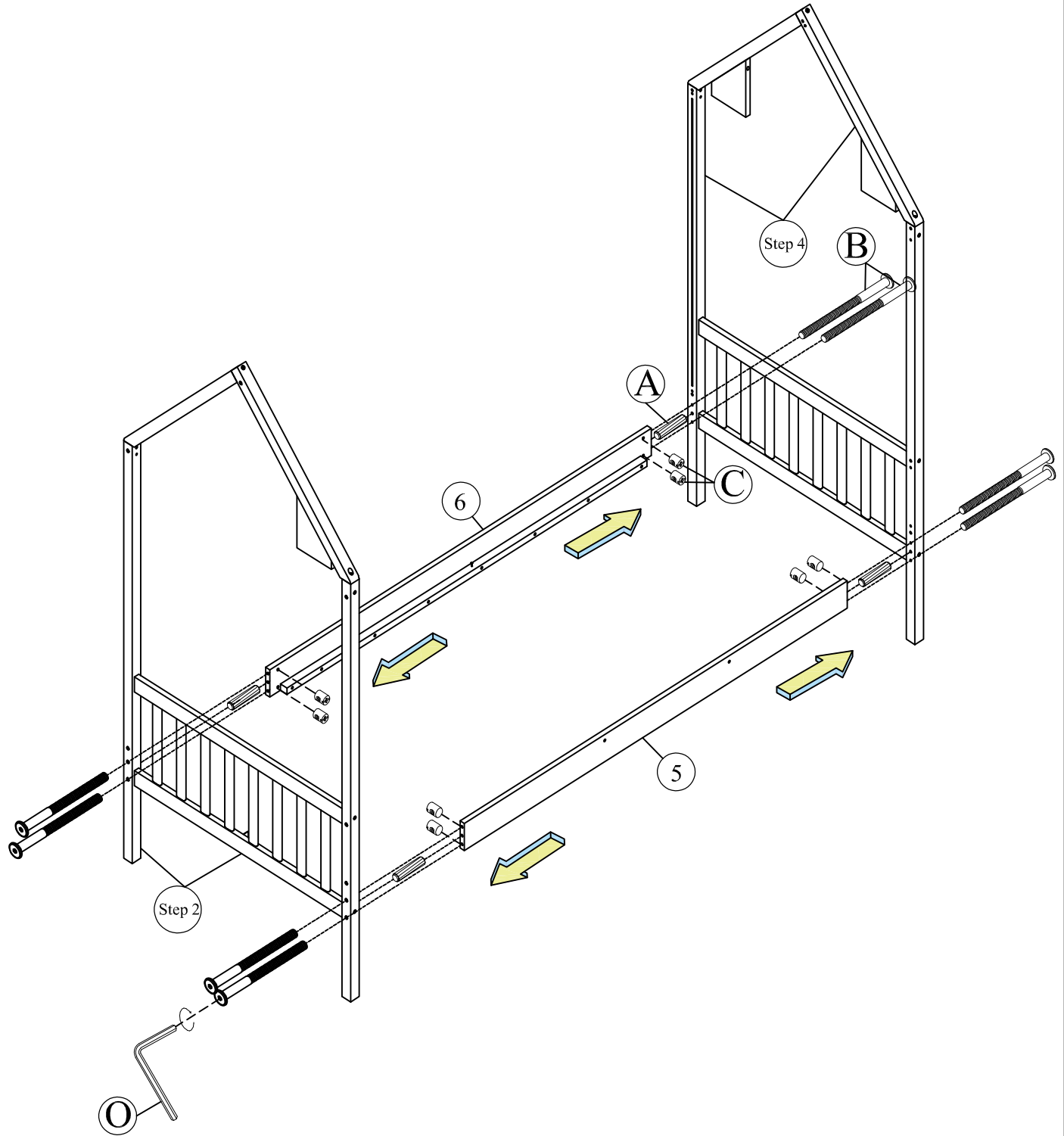

STEP 7:

A	B	C	O
			
4PCS	8PCS	8PCS	1PC





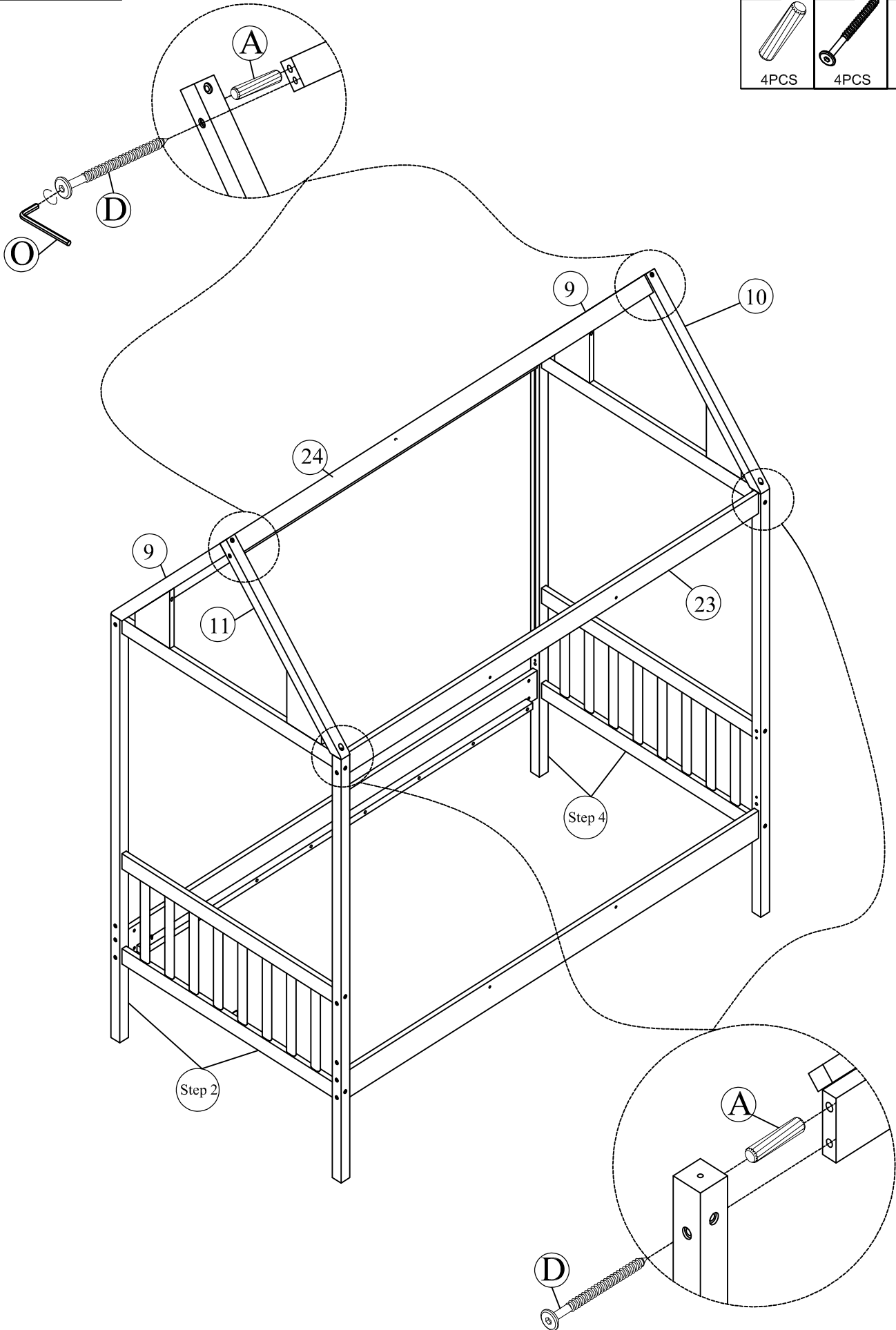

Note :
Do not lock the bolt.

STEP 8:

A	D	O
		
4PCS	4PCS	1PC

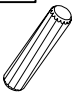

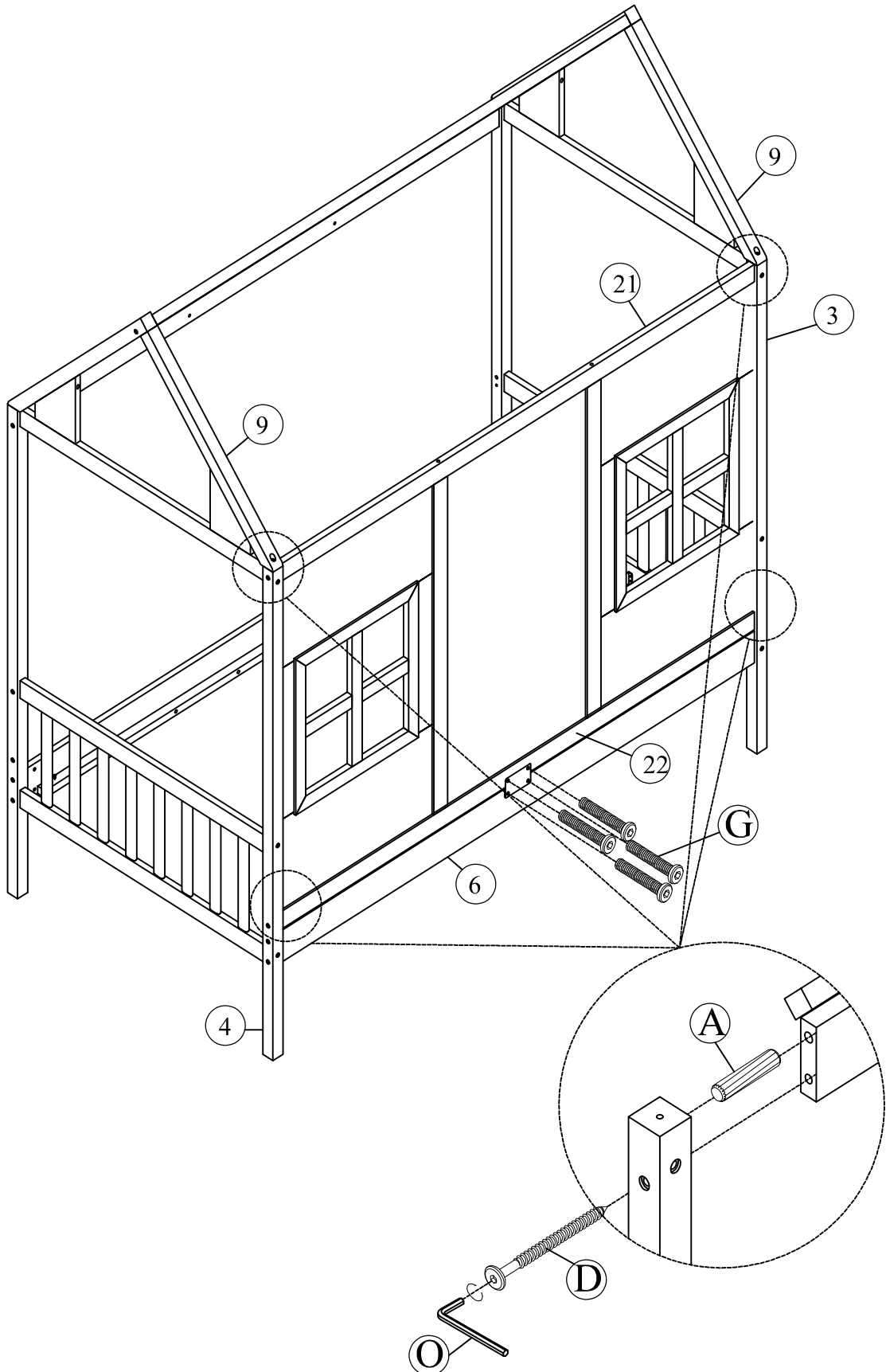

STEP 9:

A	D	G	O
			
4PCS	4PCS	4PCS	1PC



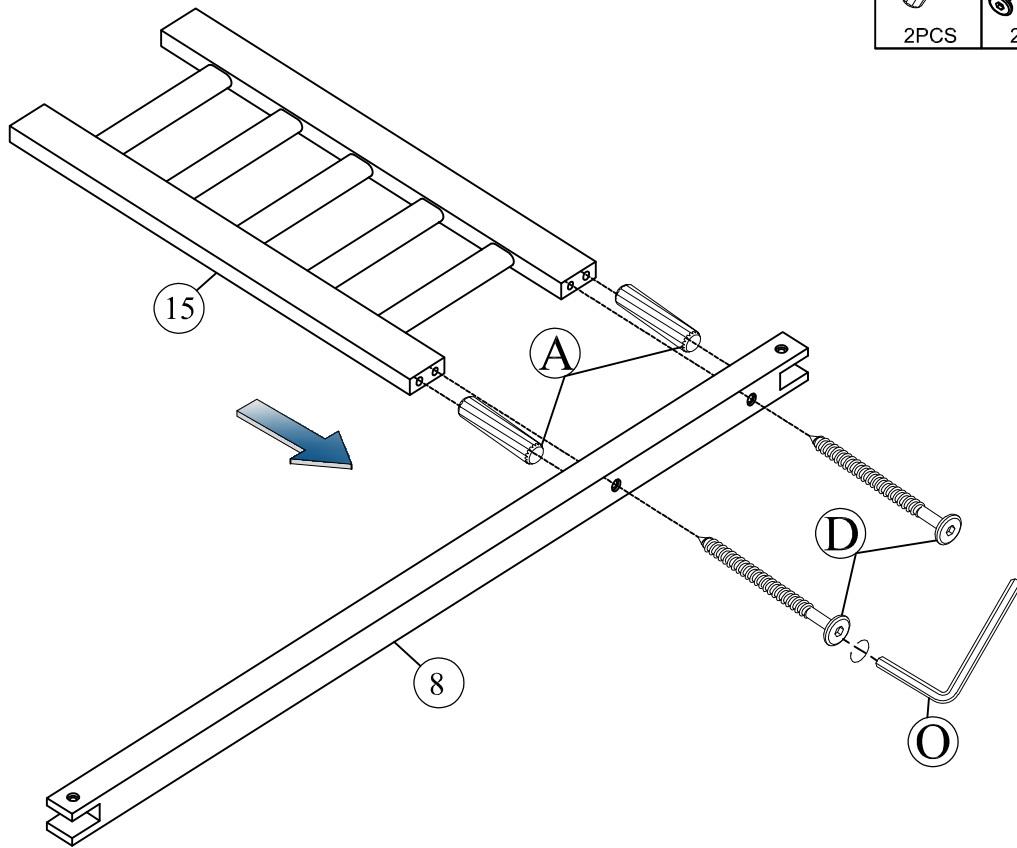

STEP 10:

A	D	O
		
2PCS	2PCS	1PC



STEP 11:

A	D	O
		
2PCS	2PCS	1PC

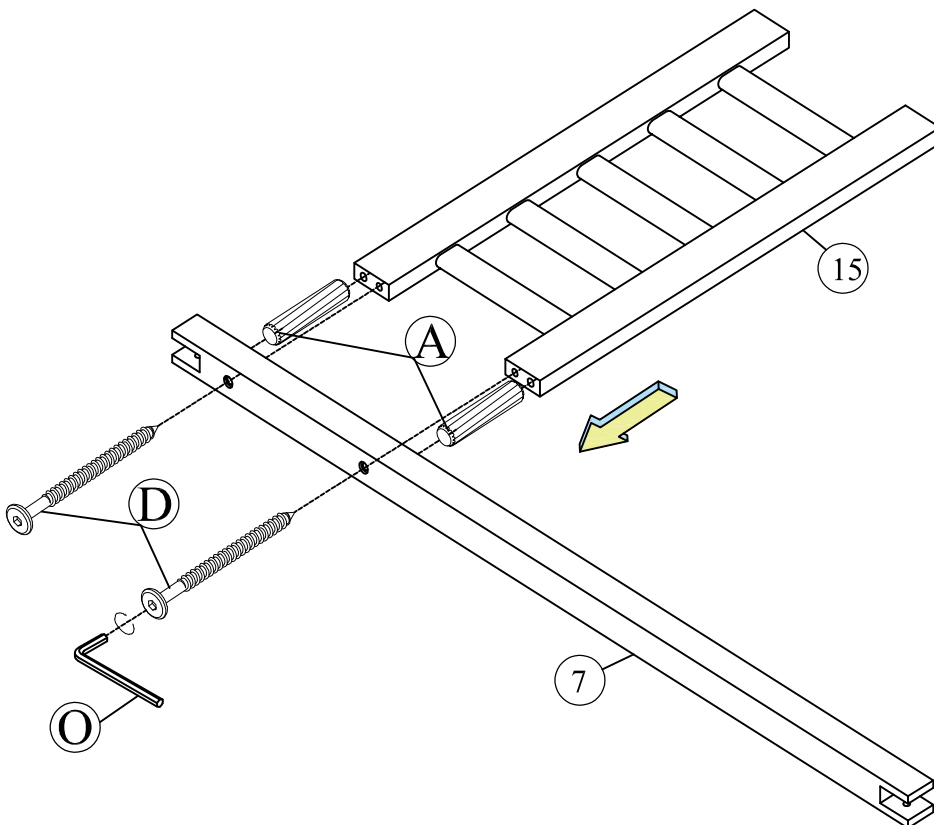

STEP 12:

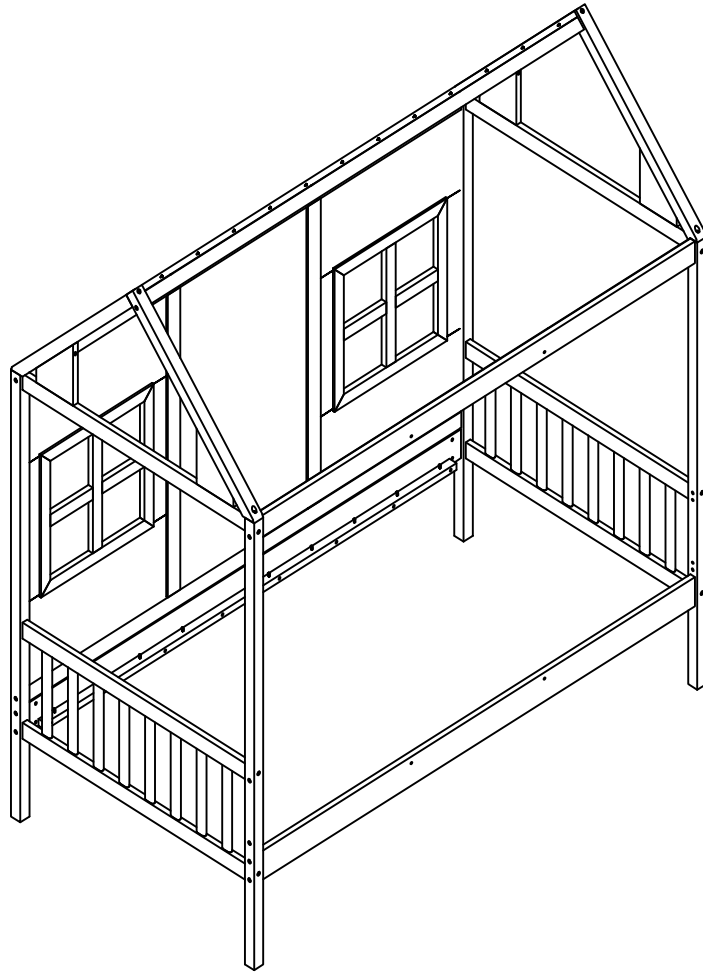

STEP 13:





M

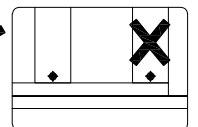
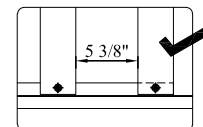
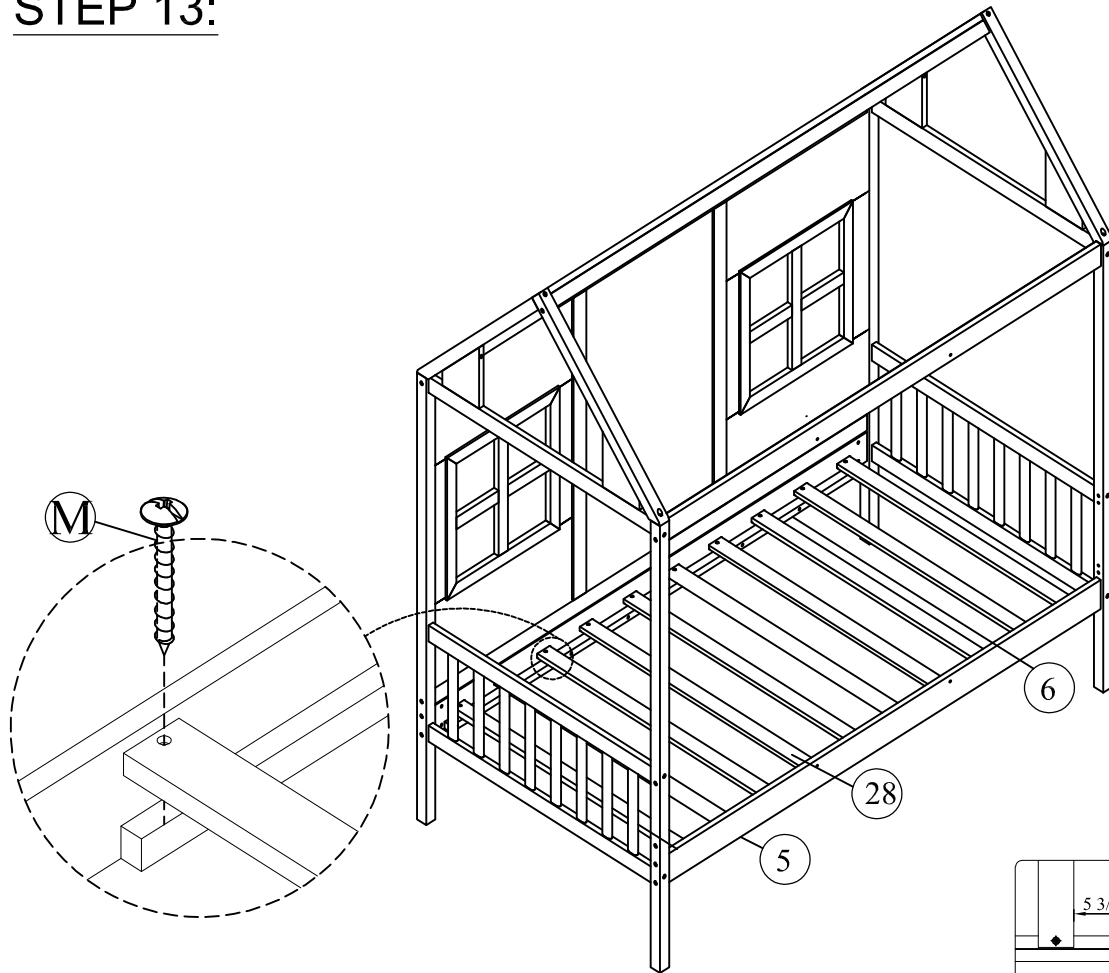

20PCS



STEP 14:

A	D	E	O
			
4PCS	4PCS	4PCS	1PC

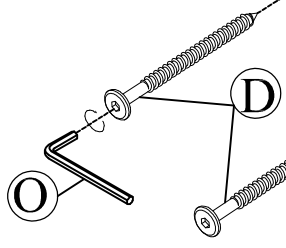
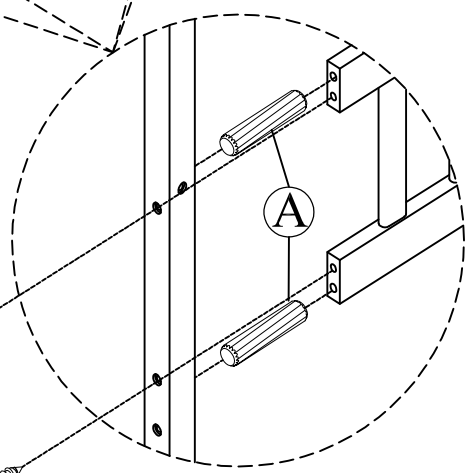
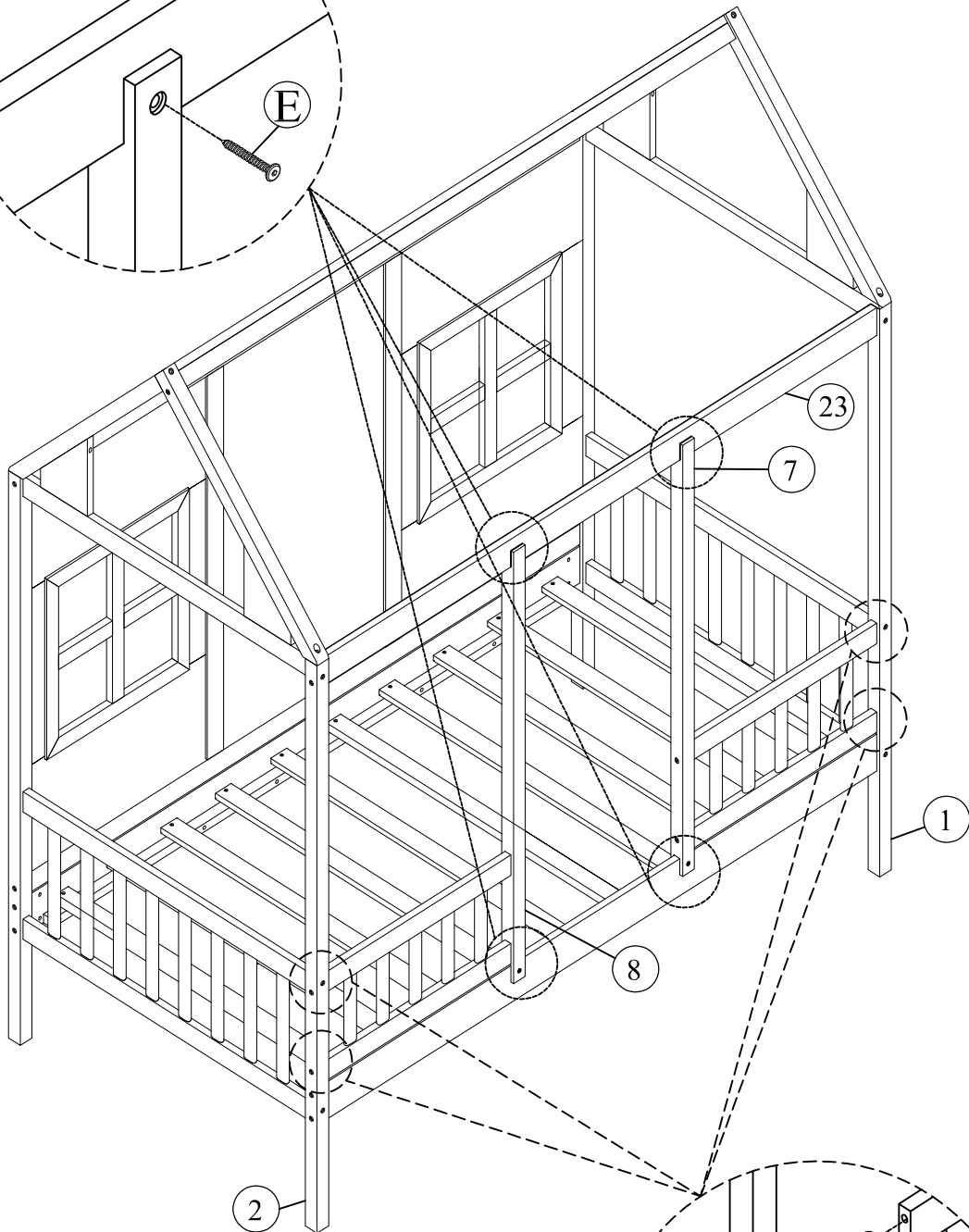
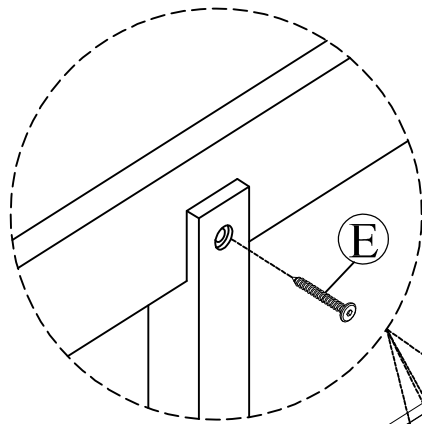

Note :
Lock the bolt.

STEP 15:

M



12PCS

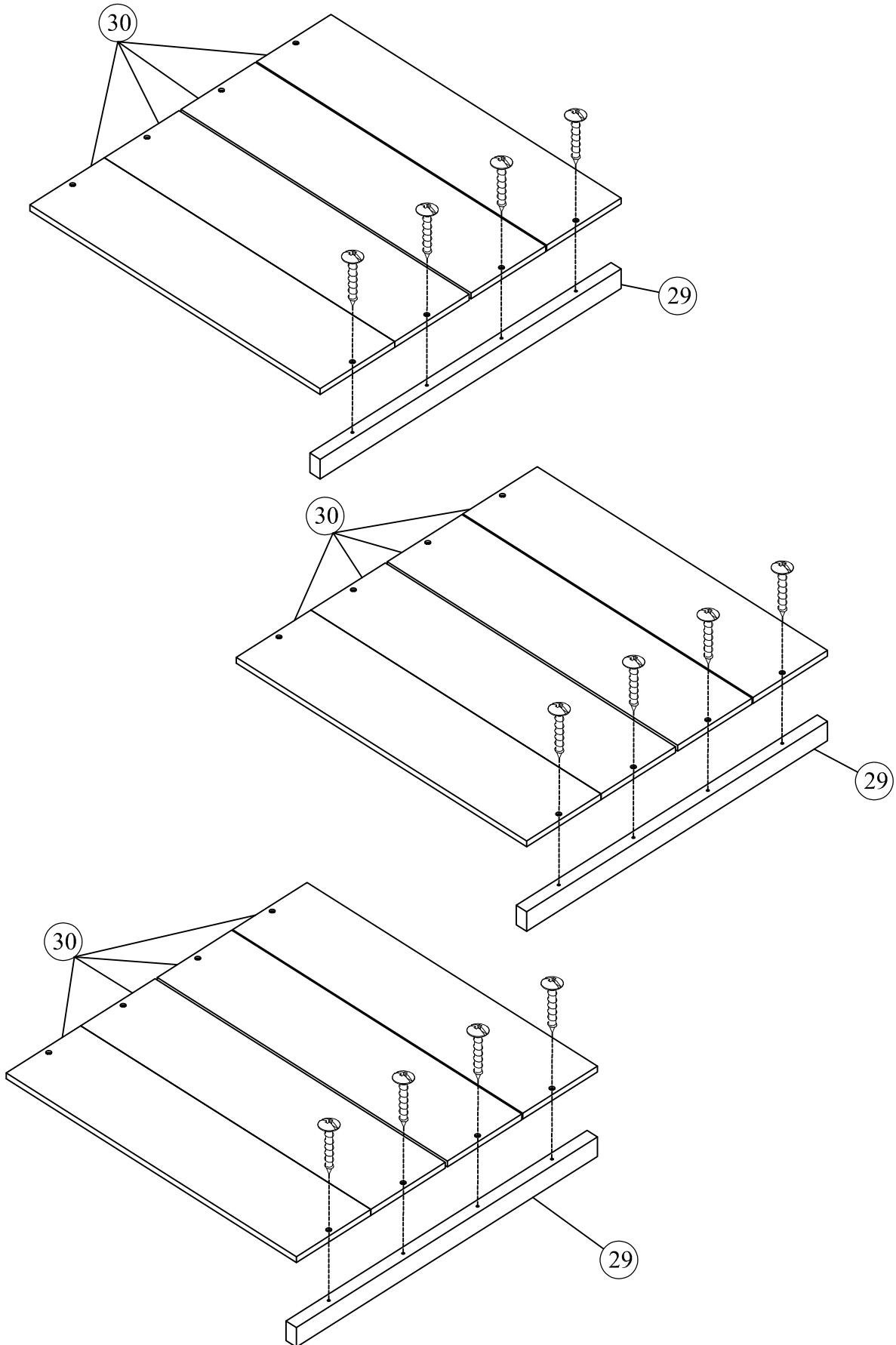

STEP 16:

M



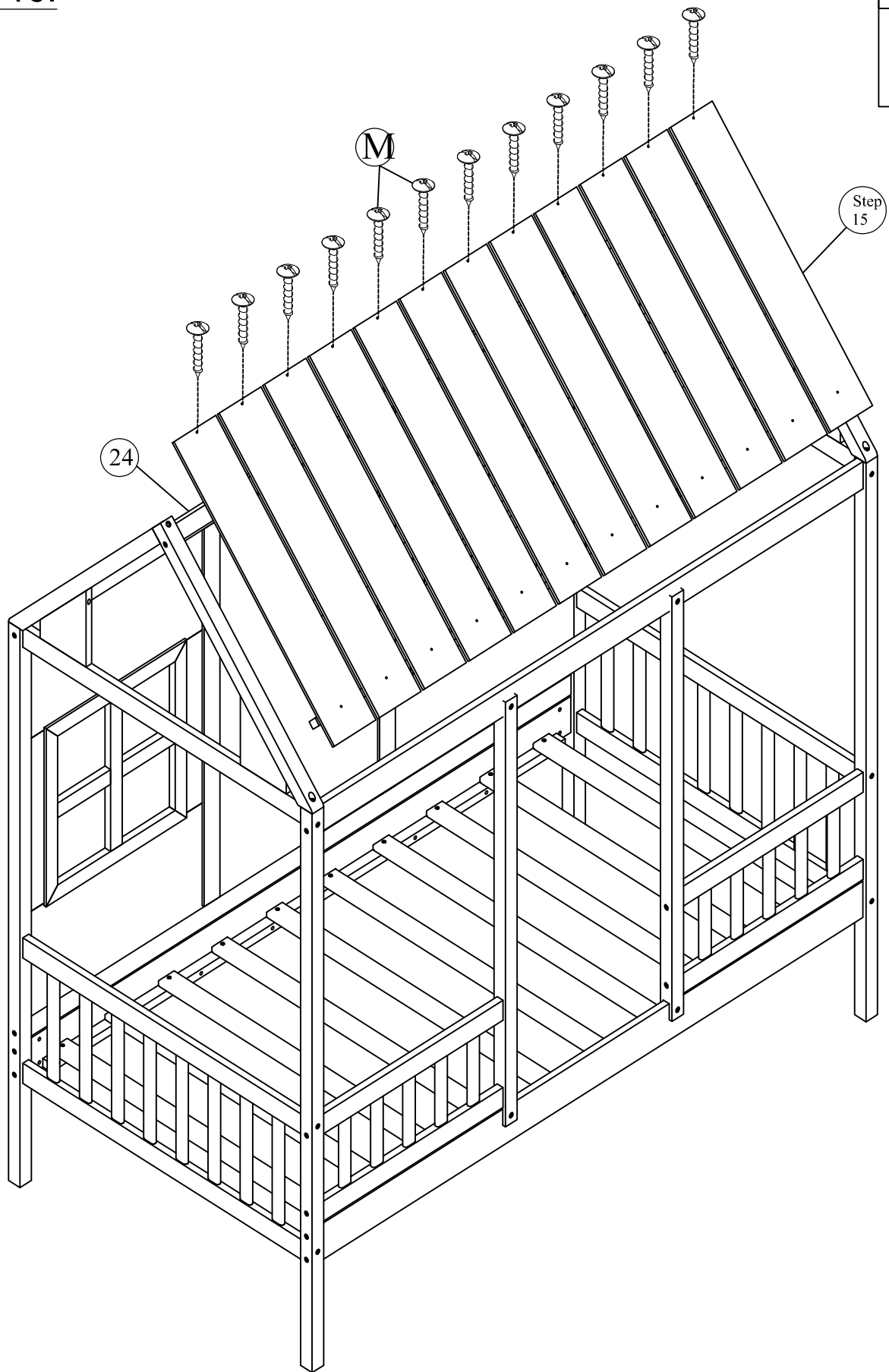

12PCS

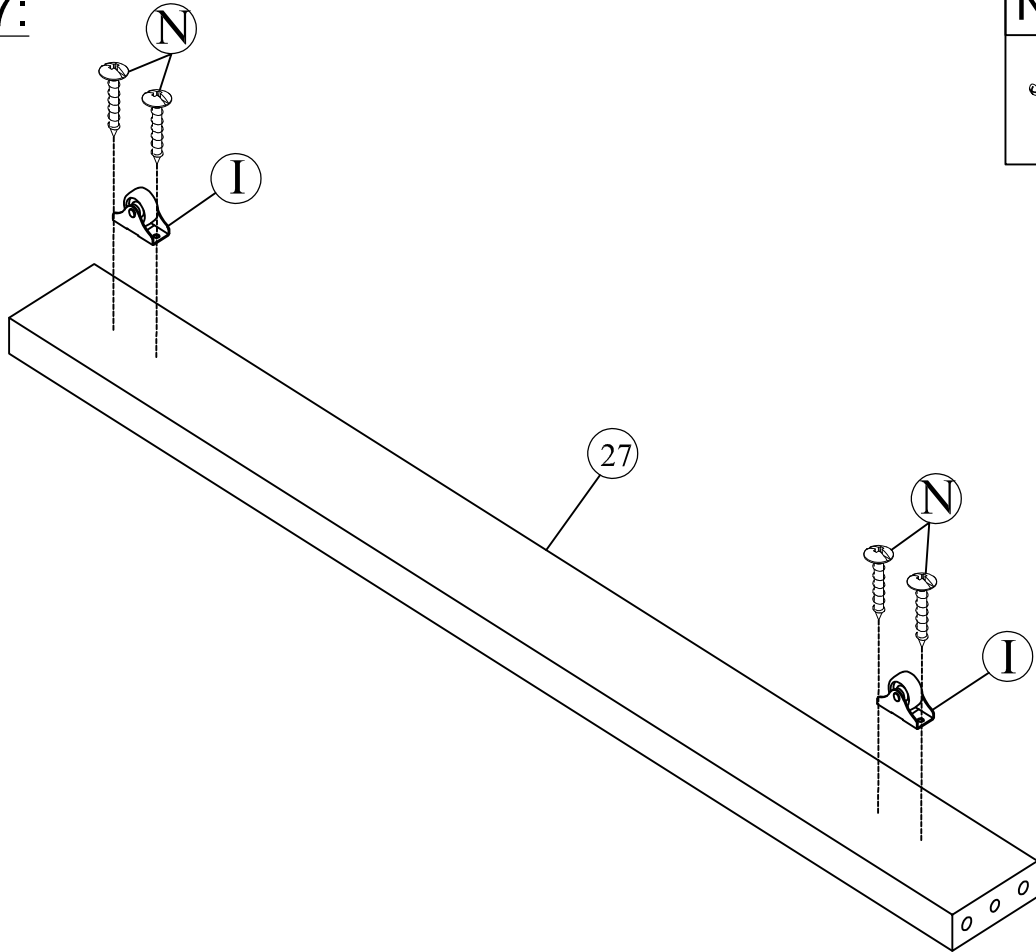

STEP 17:





N	I
	
8PCS	4PCS

X2

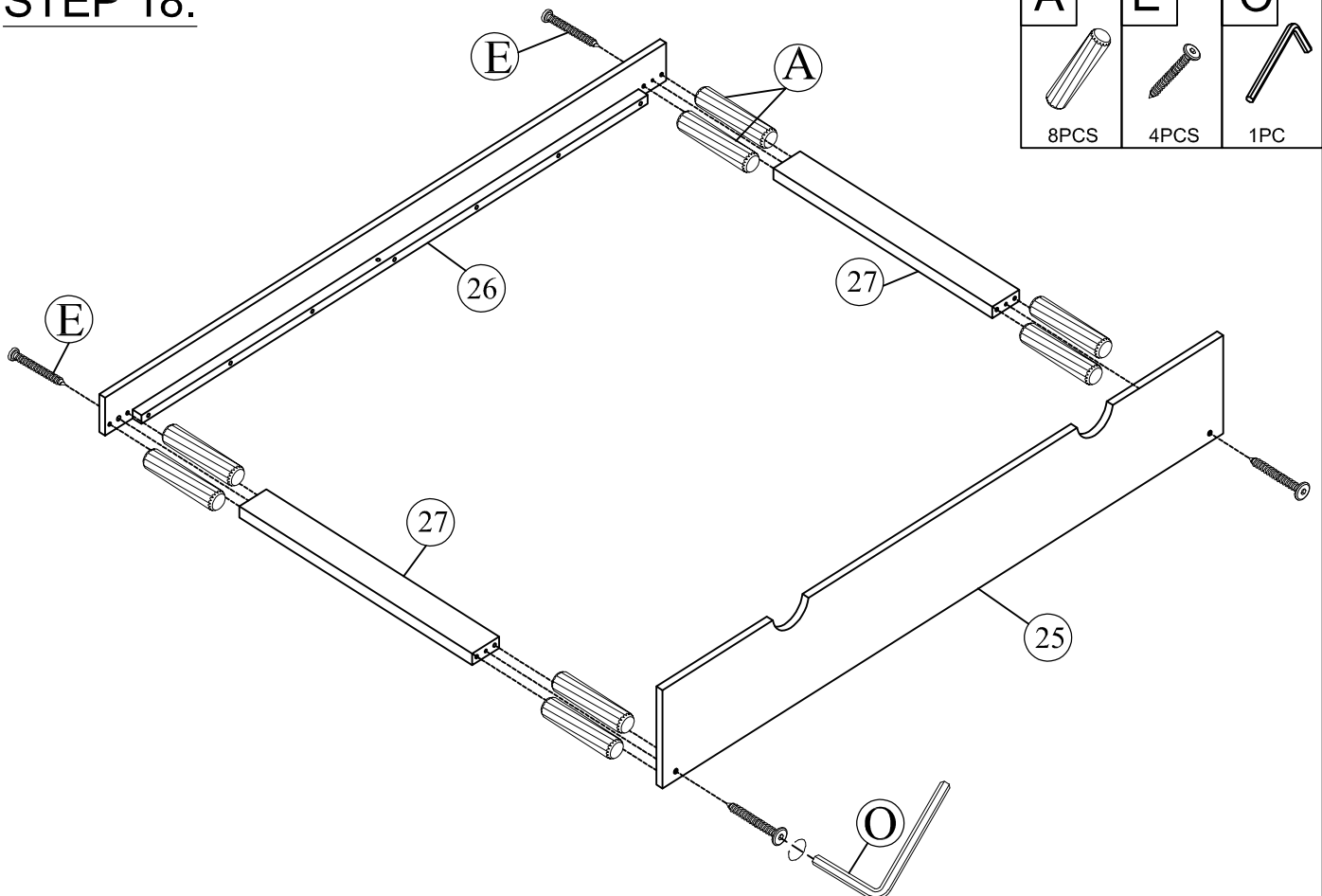
STEP 18:



A	E	O
		
8PCS	4PCS	1PC

STEP 19:

M



12PCS

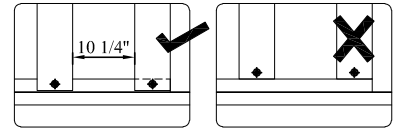
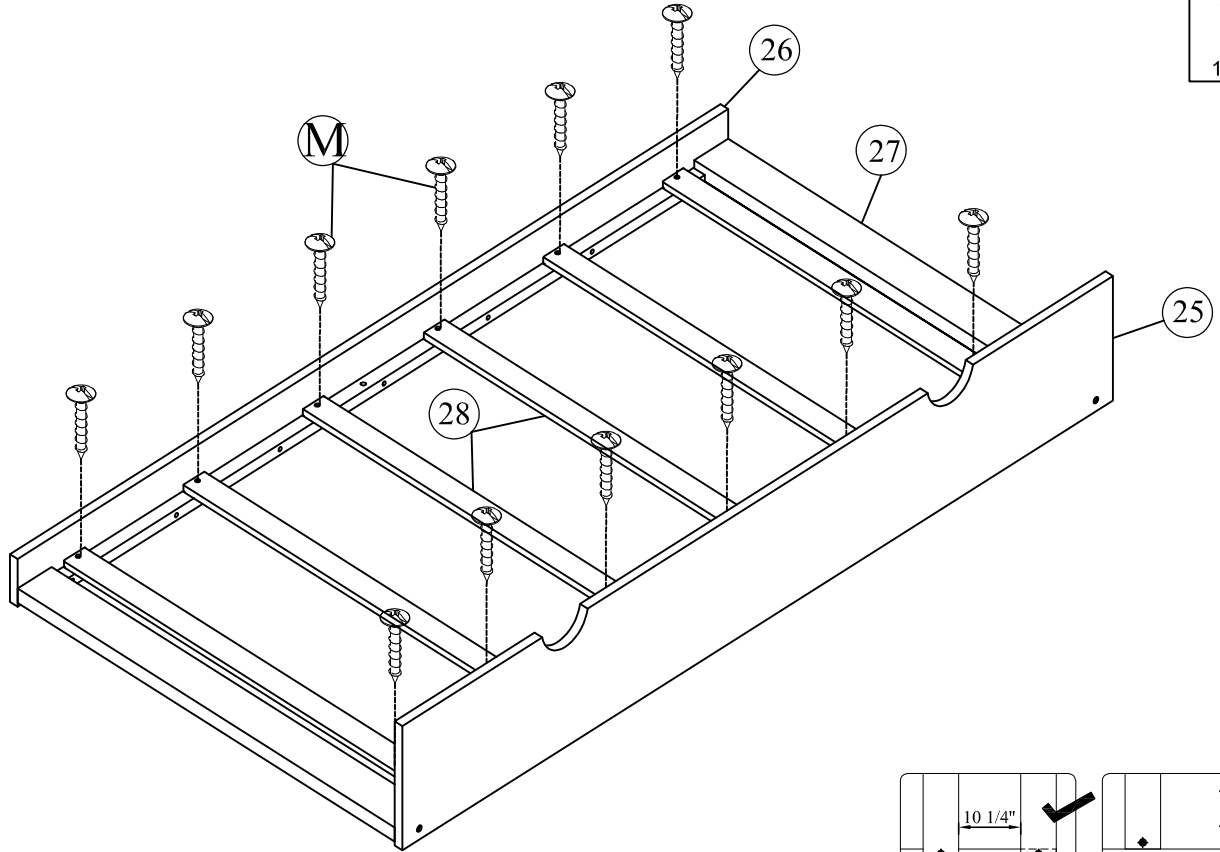

STEP 20:

P



2PCS

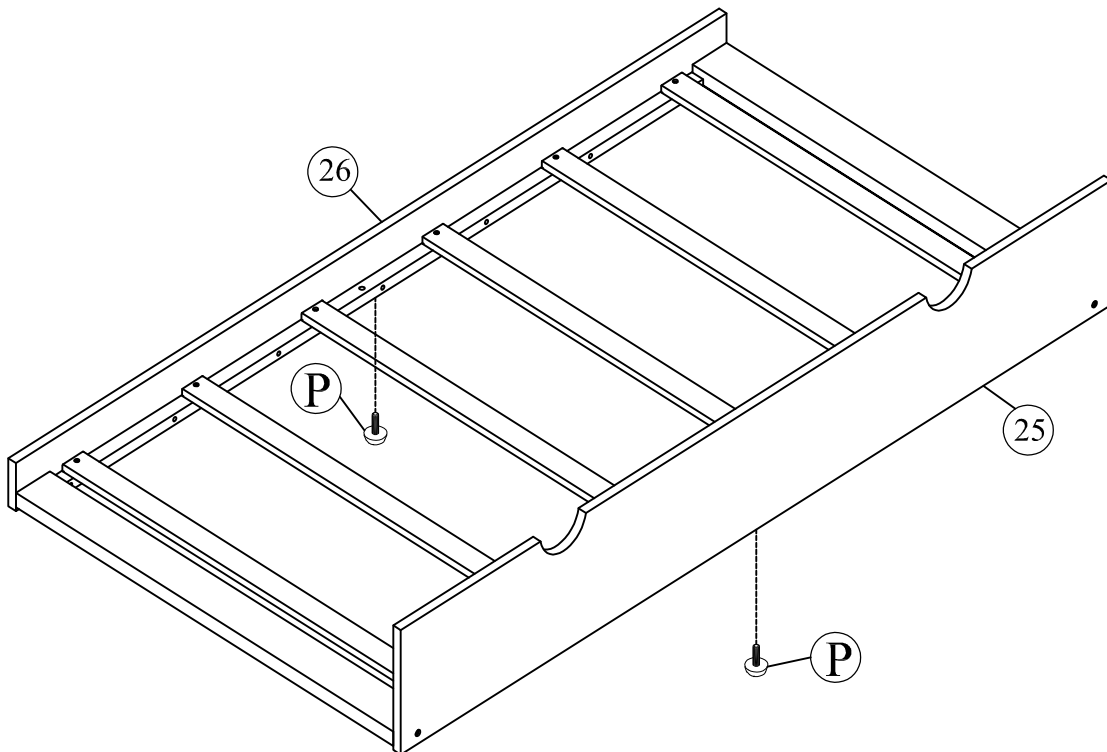

STEP 21:

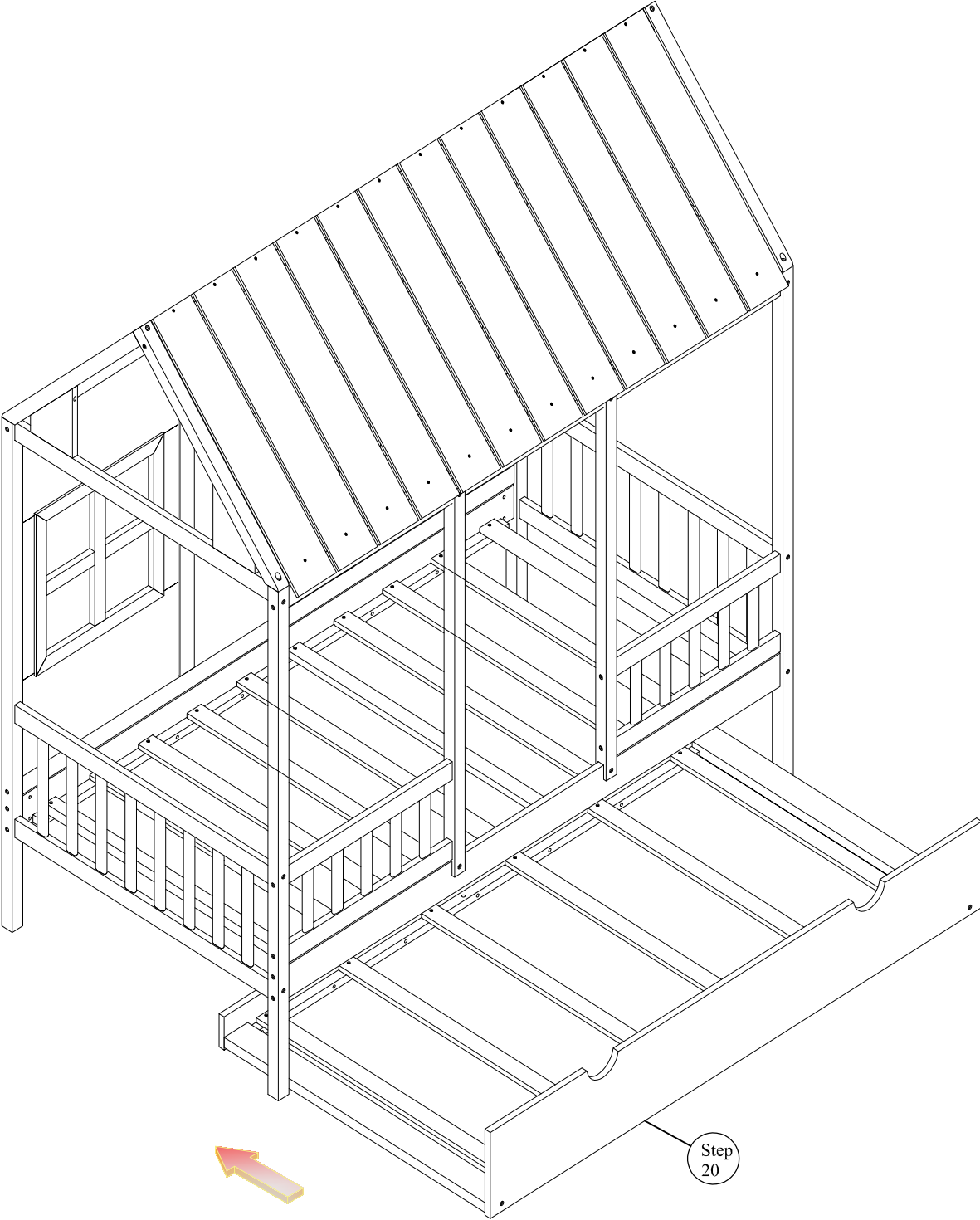

COMPLETED

