

ASSEMBLY INSTRUCTIONS

SKU CODE: MF300406/MF300407

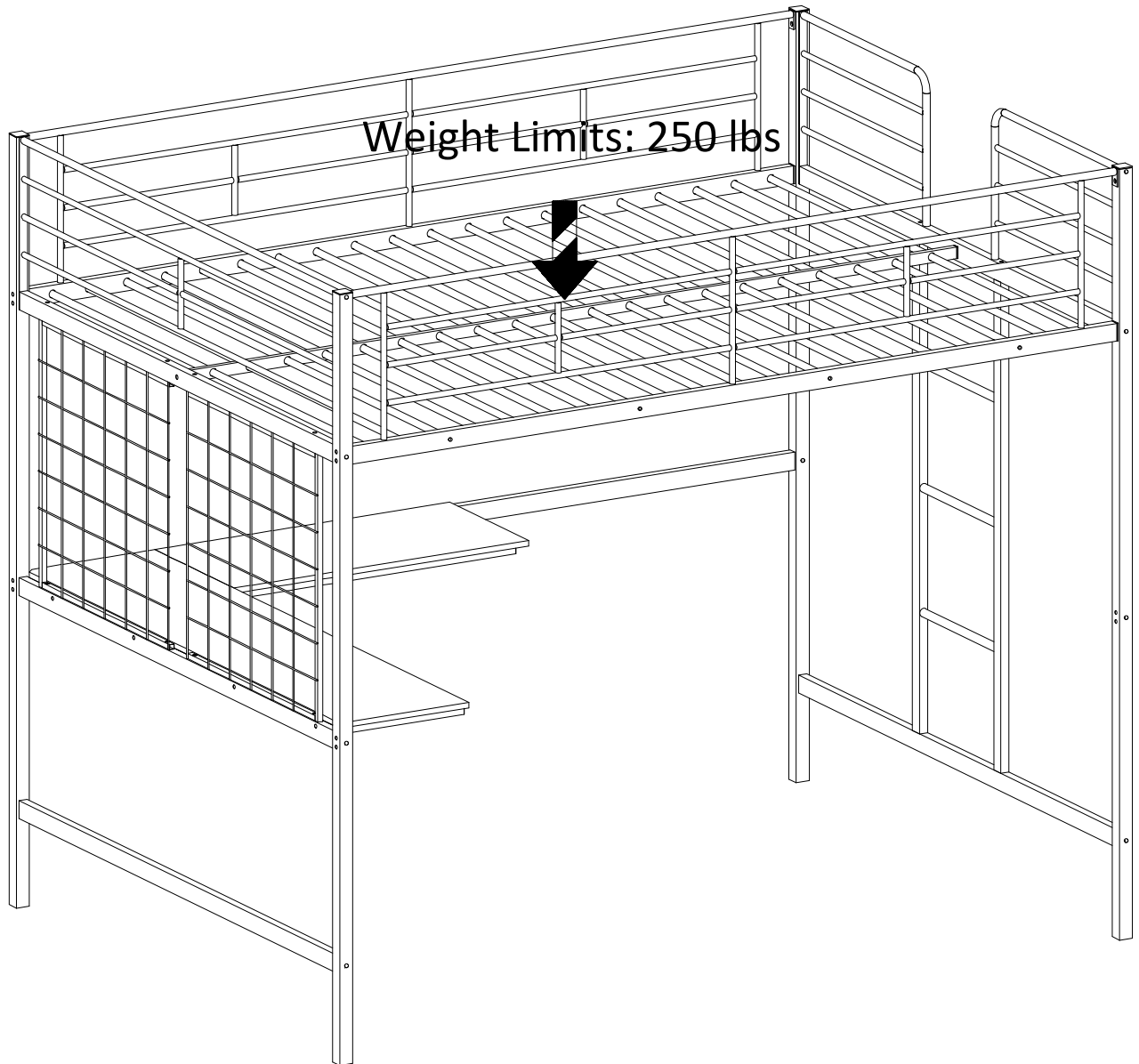



SAFETY WARNING



1. This bed is designed for use only mattress (es) meeting the following specifications on the upper bunk:

Upper bunk

Bed type	Length	Width	Thickness
Full Standard	74" - 75"	53 ½"	6" max

2. Replacement parts, including additional guardrails, maybe obtained from any of our (GIGACLOUD TECHNOLOGY (USA) INC. 18961 ARENTH AVENUE CITY OF INDUSTRY, CA, 91748) dealers
3. Follow the information on the warnings appearing on the upper bunk bed end structure and on the carton. Do not remove warning label from bed.
4. Always use the recommended size mattresses or mattress supports, or both, to help prevent the likelihood of entrapment or falls.
5. Surface of mattress must be at least 5" (127mm) below the upper edge of guardrails.
6. Do not allow children under 6 years of age to use the upper bunk.
7. Periodically check and ensure that the guardrail, ladder, and other components are in their proper position, free from damage, and that all connectors are tight.
8. Do not allow horseplay on or under the bed and prohibit jumping on the bed.
9. Always use the ladder for entering and leaving the upper bunk.
10. Do not use substitute part. Contact the manufacture or dealer for replacement part.
11. Use of a night light may provide added safety precaution for a child using the upper bunk.
12. Always use guardrails on both long sides of the upper bunk. If the bunk bed will be placed next to the wall, the guardrail that runs the full length of the bed should be placed against the wall to prevent entrapment between the bed and wall.
13. The use of water or sleep flotation mattresses is prohibited.
14. STRANGULATION HAZARD - Never attach or hang items to any part of the bunk bed that are not designed for use with the bed; for example, but not limited to, hook, belts and jump ropes.
15. Keep these instruction for future reference.
16. Prohibit more than one person on upper bunk
17. We recommend assembling your bunk bed on the shipping carton to protect your floor or carpet.
18. Be certain all staples are out of the box before beginning assembly on the shipping carton.

ASSEMBLY INSTRUCTIONS

BUNK BED



Thank you for purchasing this quality product. Be sure to check all packing material carefully for small parts which may have come loose inside the carton during shipment. Separate, identify and count all parts and hardware.

Compare with the parts list to be sure all parts are present.

"DO NOT TIGHTEN SCREWS UNTIL COMPLETELY ASSEMBLED"

Detail View

BUNK BED

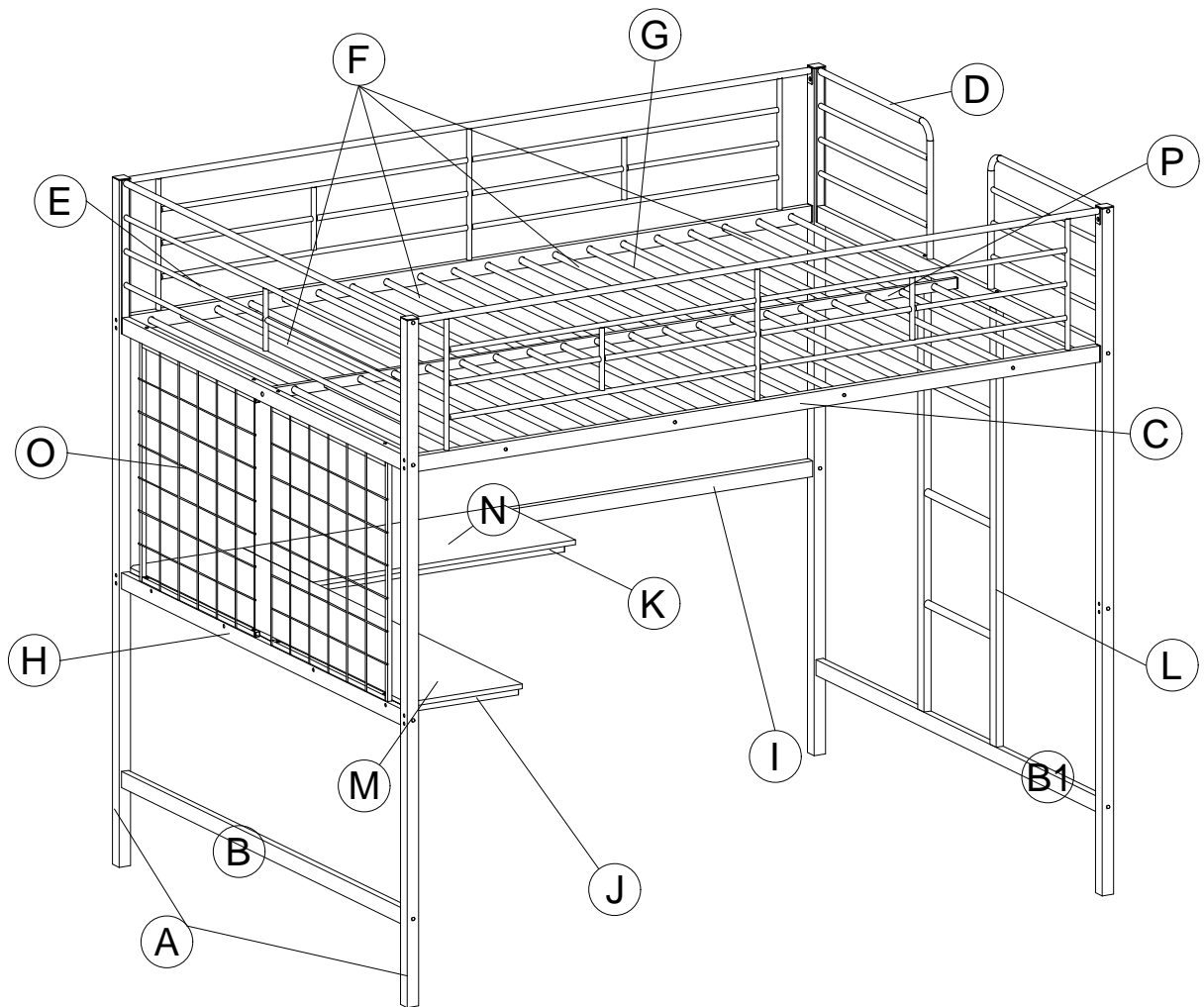

IMPORTANT:
PLEASE READ INSTRUCTION BEFORE STARTING THE ASSEMBLY

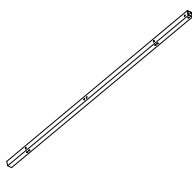
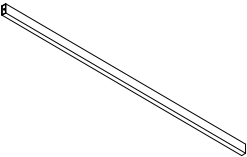
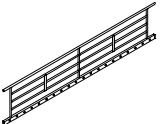
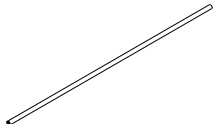
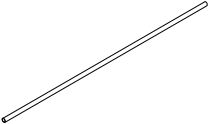
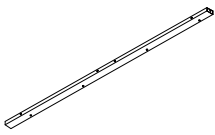
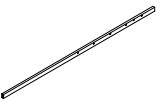
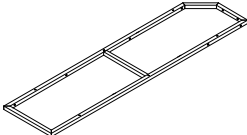
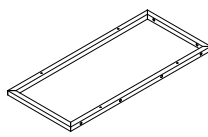
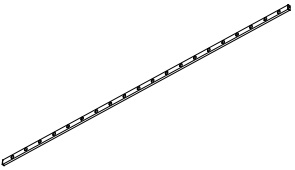
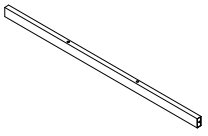

PART LIST MF300406

<p>(A) Vertical bar</p>  <p style="text-align: right;">4 pcs</p>	<p>(B) Horizontal bar</p>  <p style="text-align: right;">1 pc</p>	<p>(C) Guard Frame</p>  <p style="text-align: right;">2 pcs</p>	<p>(F) Slats</p>  <p style="text-align: right;">4 pcs</p>
<p>(G) Slats</p>  <p style="text-align: right;">16 pcs</p>	<p>(H) Horizontal bar</p>  <p style="text-align: right;">1 pc</p>	<p>(I) Horizontal bar</p>  <p style="text-align: right;">1 pc</p>	<p>(J) Desk Frame</p>  <p style="text-align: right;">1 pc</p>
<p>(K) Desk Frame</p>  <p style="text-align: right;">1 pc</p>	<p>(P) Horizontal bar</p>  <p style="text-align: right;">1 pc</p>	<p>(B1) Horizontal bar</p>  <p style="text-align: right;">1 pc</p>	

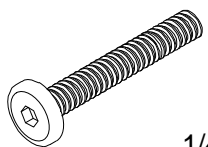
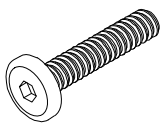
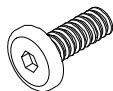
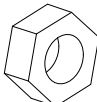
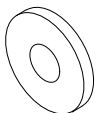
HARDWARE LIST MF300406

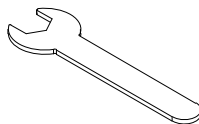
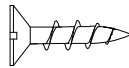
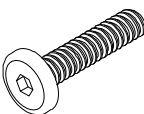
<p>(1) Bolts</p>  <p style="text-align: right;">1/4*55 42 pcs</p>	<p>(2) Bolts</p>  <p style="text-align: right;">1/4*50 8 pcs</p>	<p>(3) Bolts</p>  <p style="text-align: right;">1/4*18 12 pcs</p>	<p>(4) Nuts</p>  <p style="text-align: right;">1/4*10 12 pcs</p>
<p>(5) Washer</p>  <p style="text-align: right;">Ø6*Ø16 76 pcs</p>	<p>(6) Allen Key</p>  <p style="text-align: right;">4*59 1 pc</p>	<p>(7) Wrench</p>  <p style="text-align: right;">10*90 1 pc</p>	<p>(8) Screws</p>  <p style="text-align: right;">#8*10 8 pcs</p>
<p>(9) Bolts</p>  <p style="text-align: right;">1/4*32 2 pcs</p>			

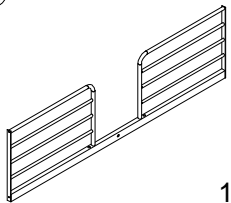
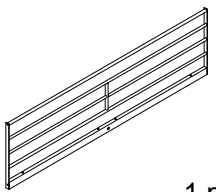
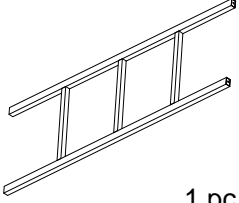
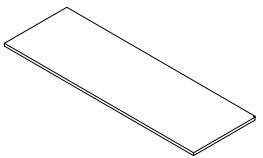
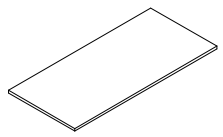
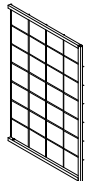

PART LIST MF300407

<p>D Guard Frame</p>  <p>1 pc</p>	<p>E Guard Frame</p>  <p>1 pc</p>	<p>L Stair</p>  <p>1 pc</p>	<p>M Plank</p>  <p>1 pc</p>
<p>N Plank</p>  <p>1 pc</p>	<p>O Net Frame</p>  <p>2 pcs</p>		

LOFT BED ASSEMBLY INSTRUCTIONS ITEM: MF300406/MF300407

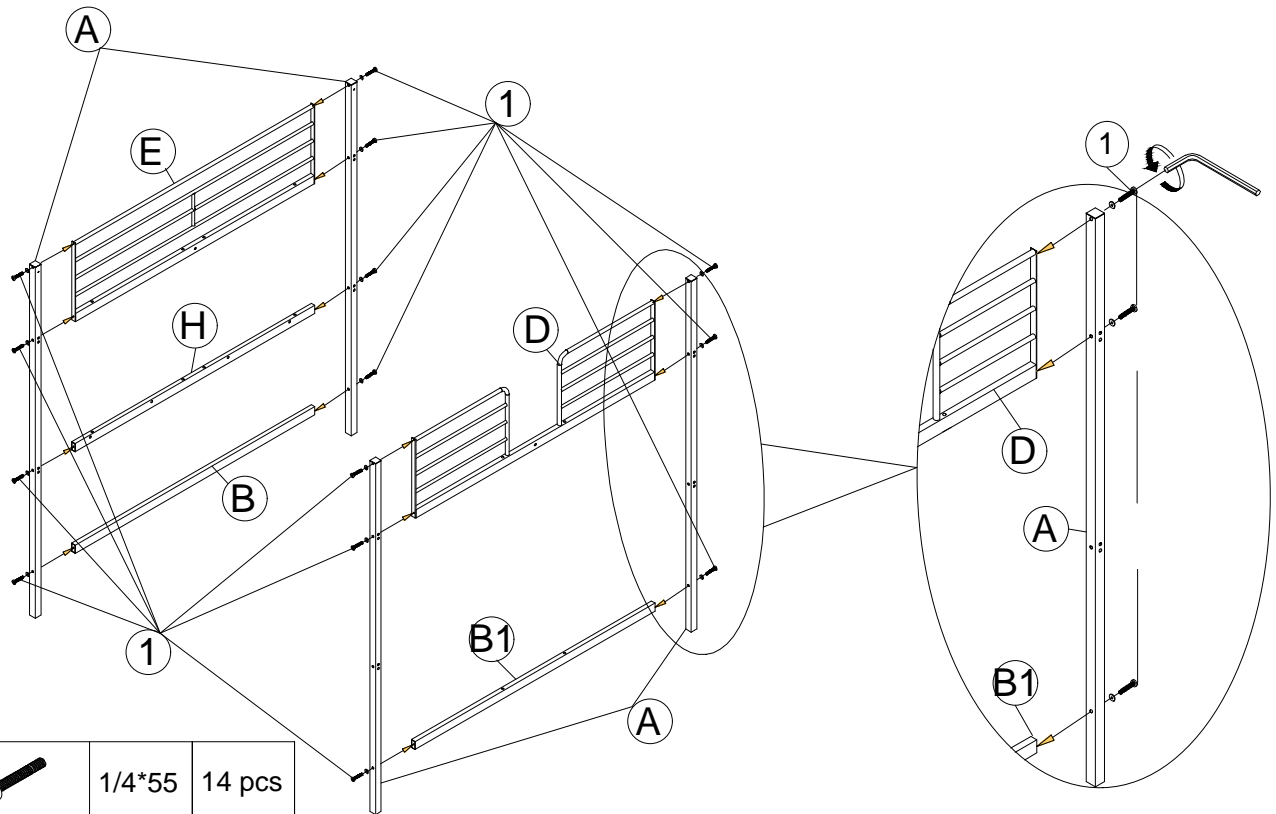
STEP 1



1		1/4*55	14 pcs
5		Ø6*Ø16	14 pcs

STEP 2

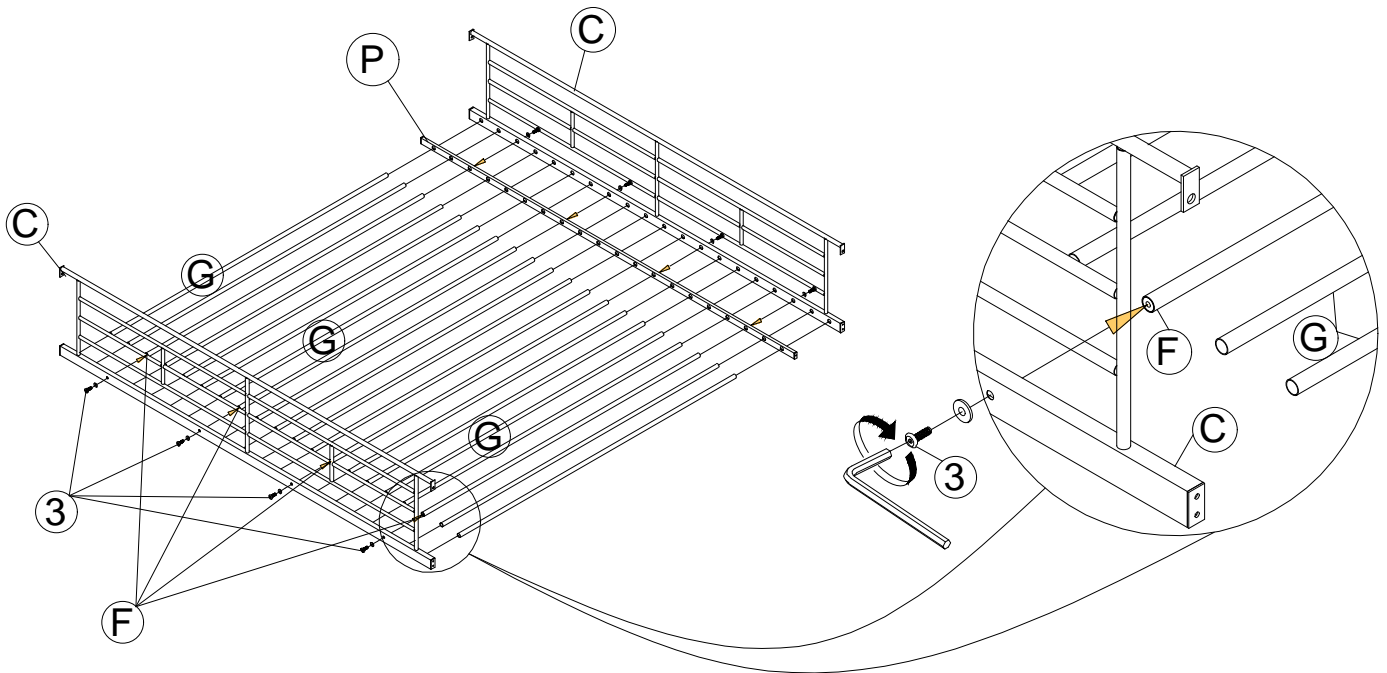

3		1/4*18	8 pcs
5		Ø6*Ø16	8 pcs

LOFT BED ASSEMBLY INSTRUCTIONS

ITEM: MF300406/MF300407

STEP 3

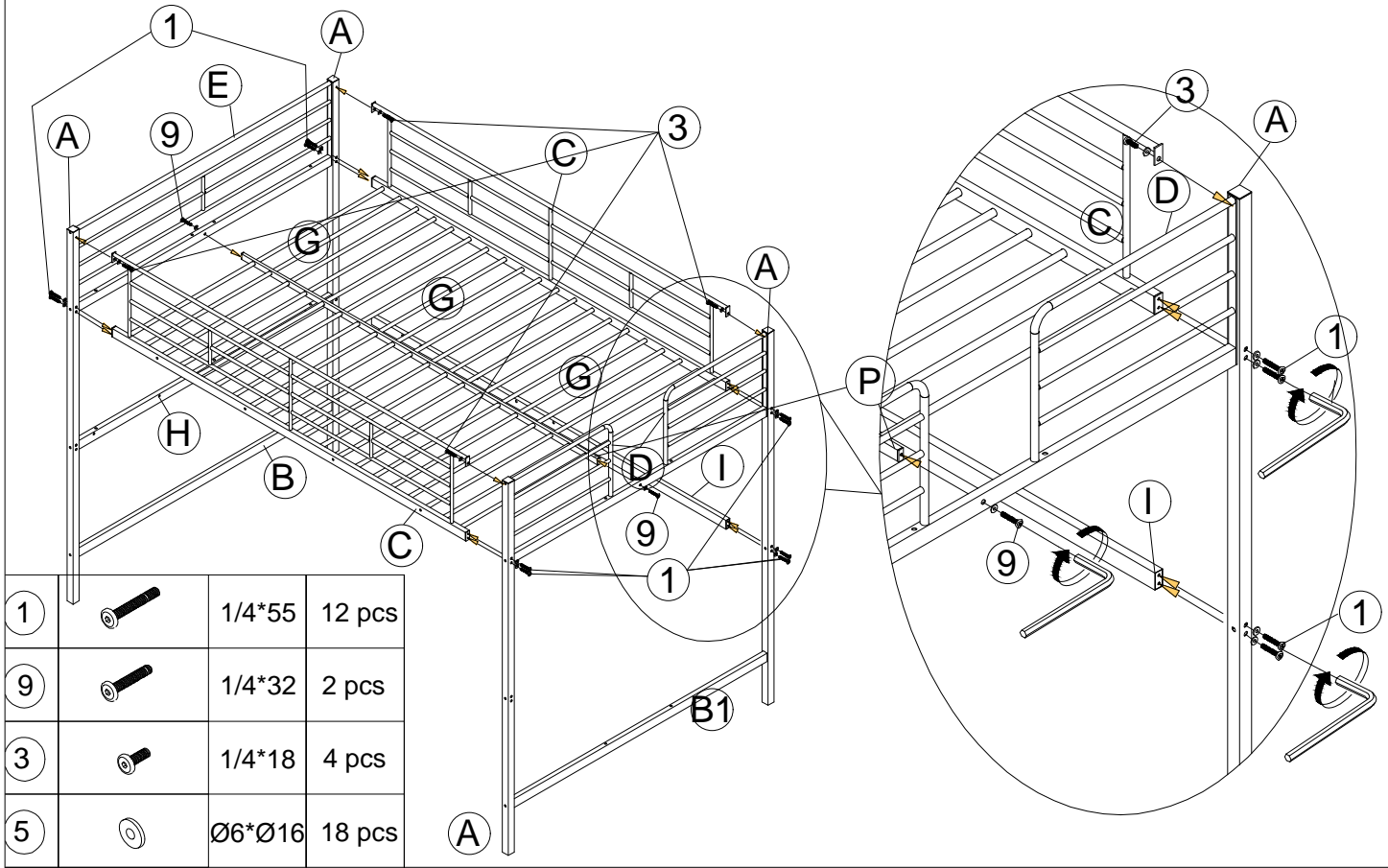

STEP 4

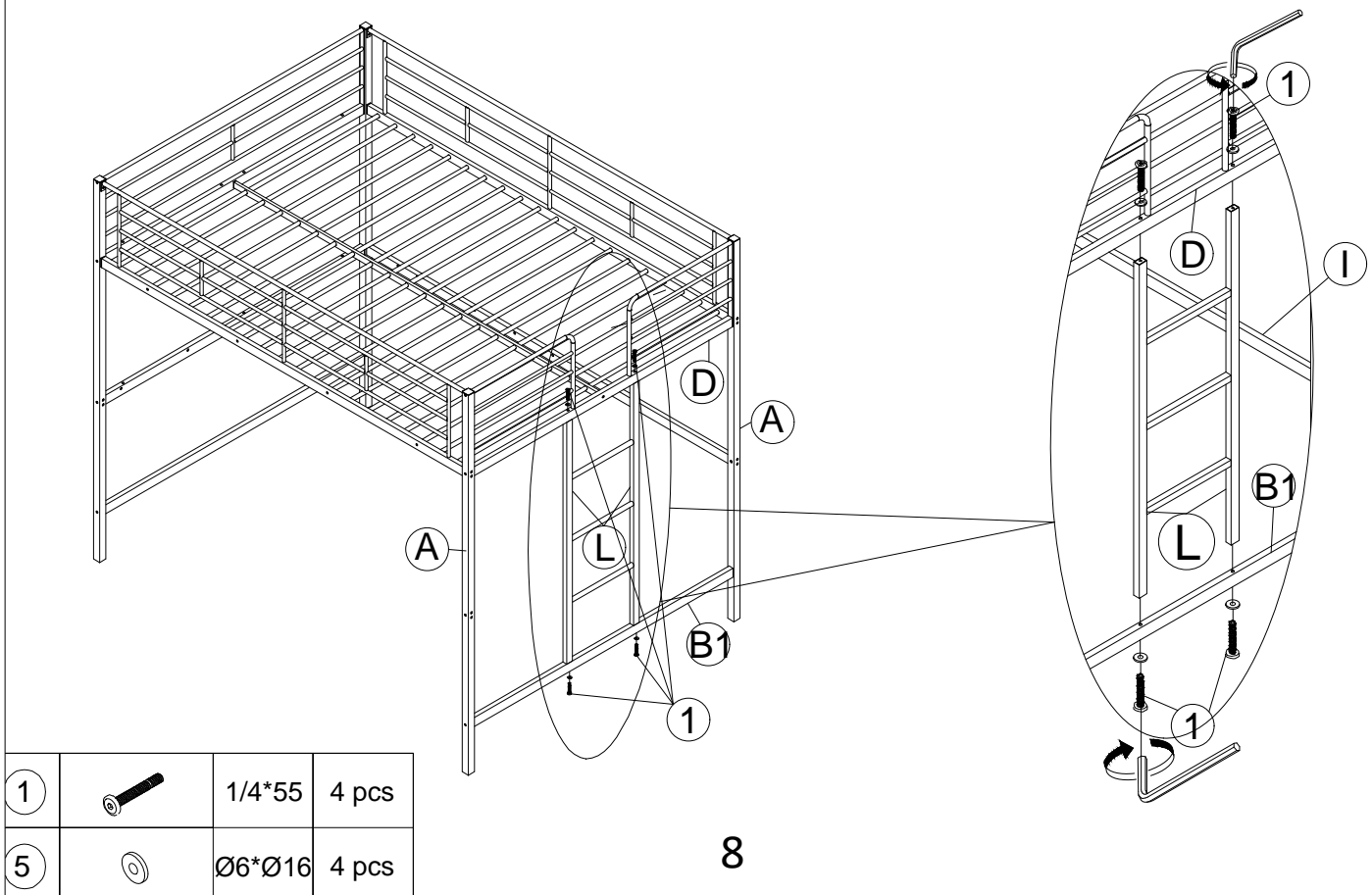



LOFT BED ASSEMBLY INSTRUCTIONS

ITEM: MF300406/MF300407

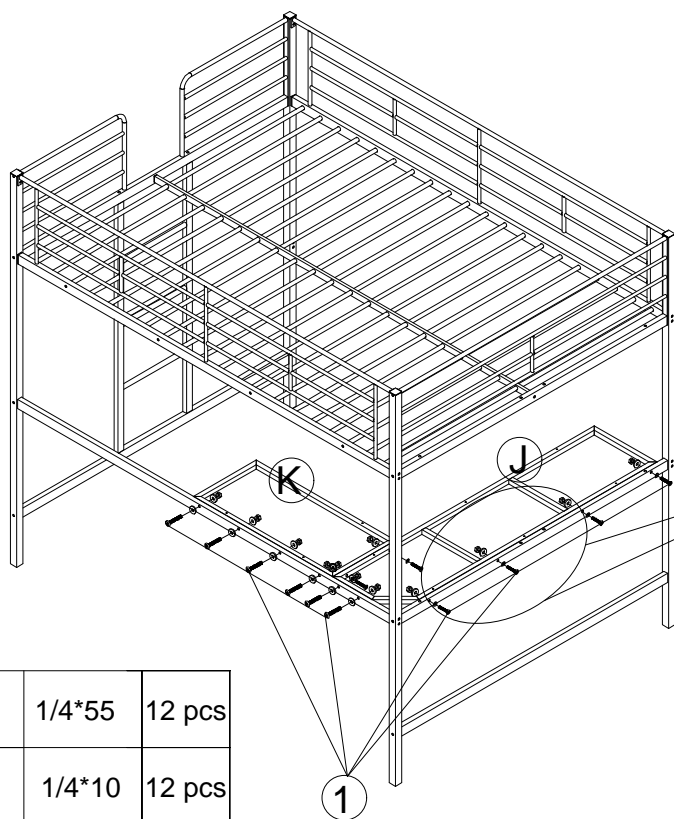
STEP 5



1		1/4*55	12 pcs
4		1/4*10	12 pcs
5		Ø6*Ø16	24 pcs

STEP 6

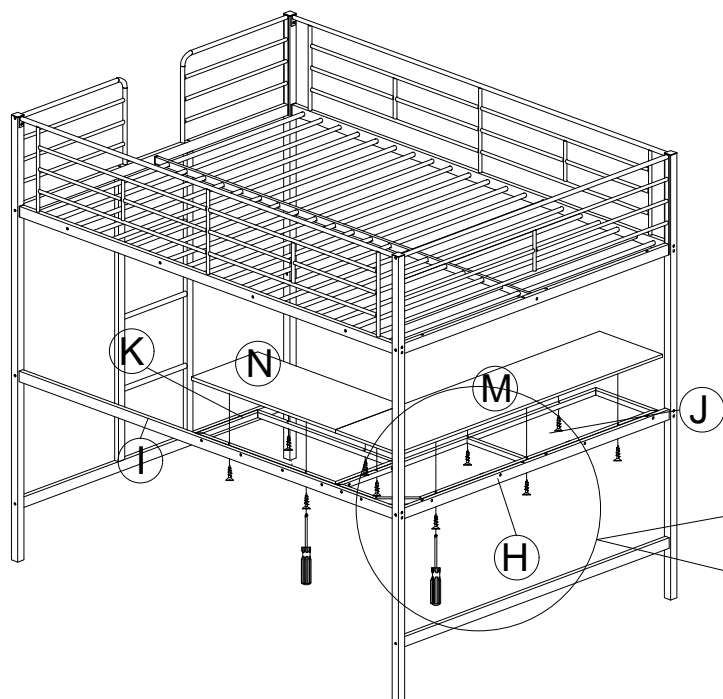



8		#8*10	10 pcs
---	---	-------	--------

LOFT BED ASSEMBLY INSTRUCTIONS ITEM: MF300406/MF300407

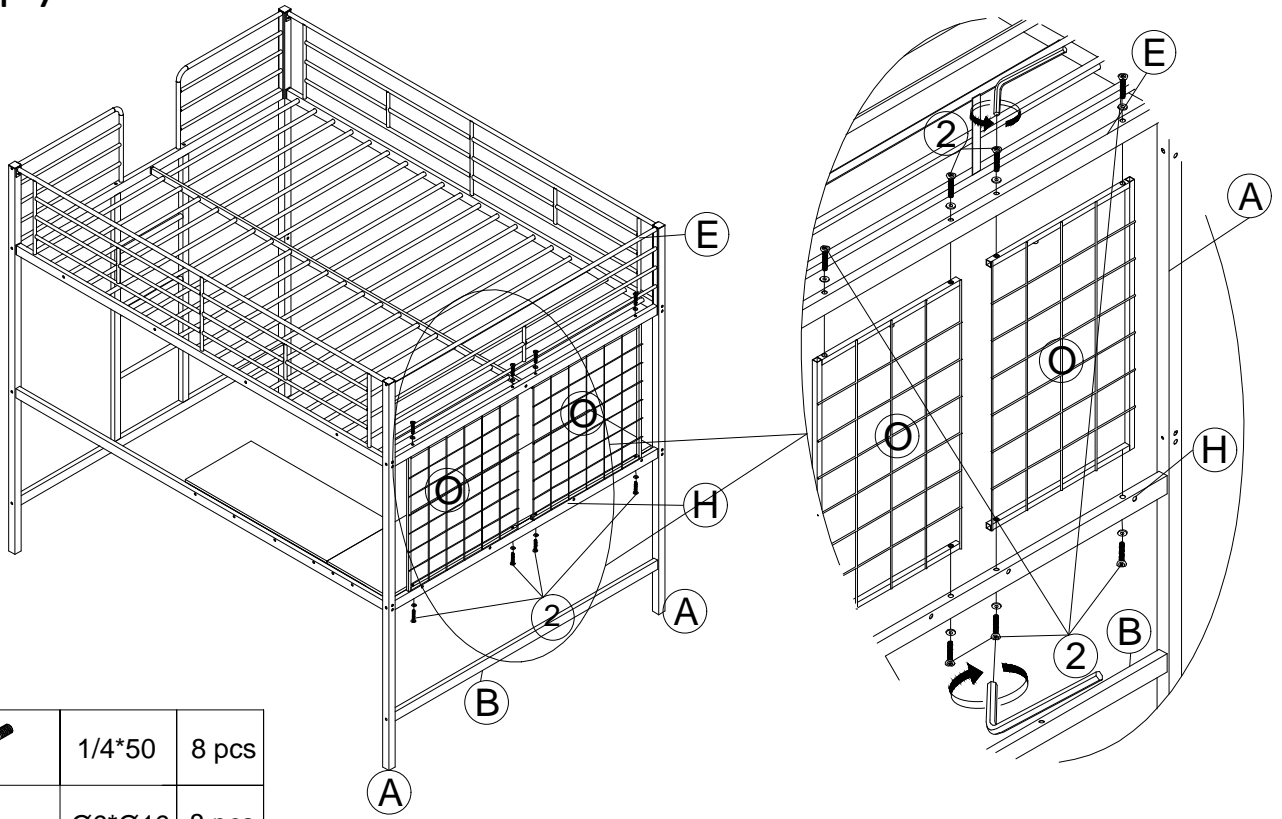
STEP 7



2		1/4*50	8 pcs
5		Ø6*Ø16	8 pcs

COMPLETE

