

ASSEMBLY INSTRUCTIONS

WF 299137









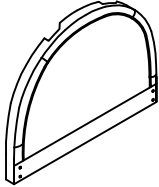

IMPORTANT NOTE

- **PLACE ALL PARTS ON A CLEAN AND SMOOTH SURFACE SUCH AS A RUG OR CARPET TO AVOID THE PARTS FROM BEING SCRATCHED**
- ** BEFORE YOU BEGIN , KINDY FOLLOW THE ASSEMBLY INSTRUCTIONS STEP BY STEP**
- **DO NOT TIGHTEN ALL SCREWS AND BOLTS UNTIL THE BED IS FULLY SET-UP**

ASSEMBLY INSTRUCTION

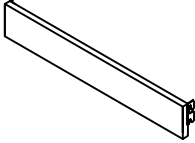
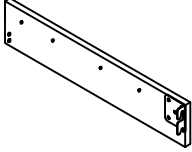

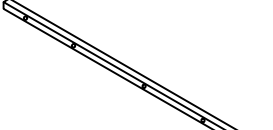
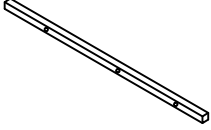

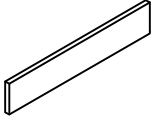
WF 299137

PART LIST BOX 1: WF 299137

<p>1</p>  <p>Headboard Panel (1 pc)</p>	<p>2</p>  <p>Left Headboard Ear (1 pc)</p>	<p>3</p>  <p>Right Headboard Ear (1 pc)</p>
<p>4</p>  <p>Leg (4 pcs)</p>	<p>5</p>  <p>Side Front Rail (2 pcs)</p>	<p>6</p>  <p>Side Back Rail (2 pcs)</p>
<p>7</p>  <p>Rail Support Legs (2 pcs)</p>	<p>8</p>  <p>Bed Support Bar (2 pcs)</p>	<p>9</p>  <p>Bed Support Bar (2 pcs)</p>
<p>10</p>  <p>Roll Slat (10 pcs) 985*60*15</p>	<p>11</p>  <p>Footboard Panel (1 pc)</p>	

ASSEMBLY INSTRUCTIONS

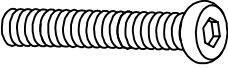
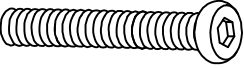

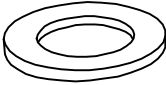
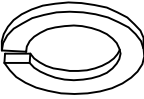
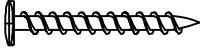

HARDWARE LIST IN WF 299137

<p>A</p>  <p>Short Bolt (8pcs) (Ø 5/16 "X25mm)</p>	<p>B</p>  <p>Long Bolt (6 pcs) (Ø 5/16 "X32mm)</p>	<p>C</p>  <p>Long Bolt (8 pcs) (Ø 5/16 "X38mm)</p>
<p>D</p>  <p>Long Bolt (16pcs) (Ø 5/16 "X45mm)</p>	<p>E</p>  <p>Long Bolt (4pcs) (Ø 5/16 "X50mm)</p>	<p>F</p>  <p>Allen Wrench (1 pc) (M4x75mm x32mm)</p>
<p>G</p>  <p>Flat Washer (42 pcs) (Ø 5/16 "-RBW)</p>	<p>H</p>  <p>Spring Washer (42 pcs) (Ø 5/16 "-RBW)</p>	<p>I</p>  <p>Flat Head Screw (20 pcs) (m4x30mm-RBW)</p>

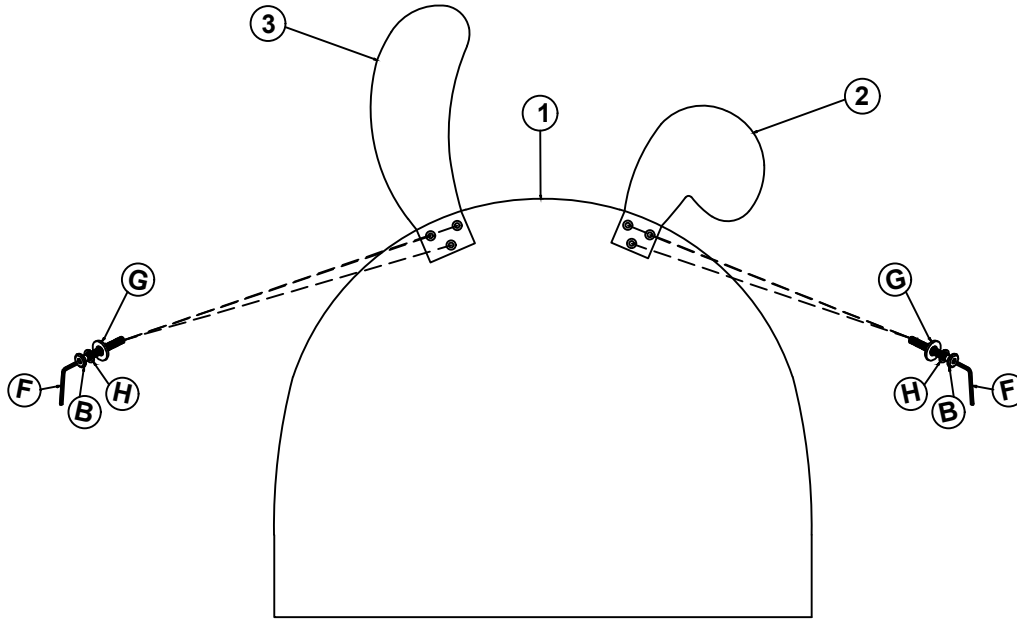
ASSEMBLY INSTRUCTIONS





STEP 1

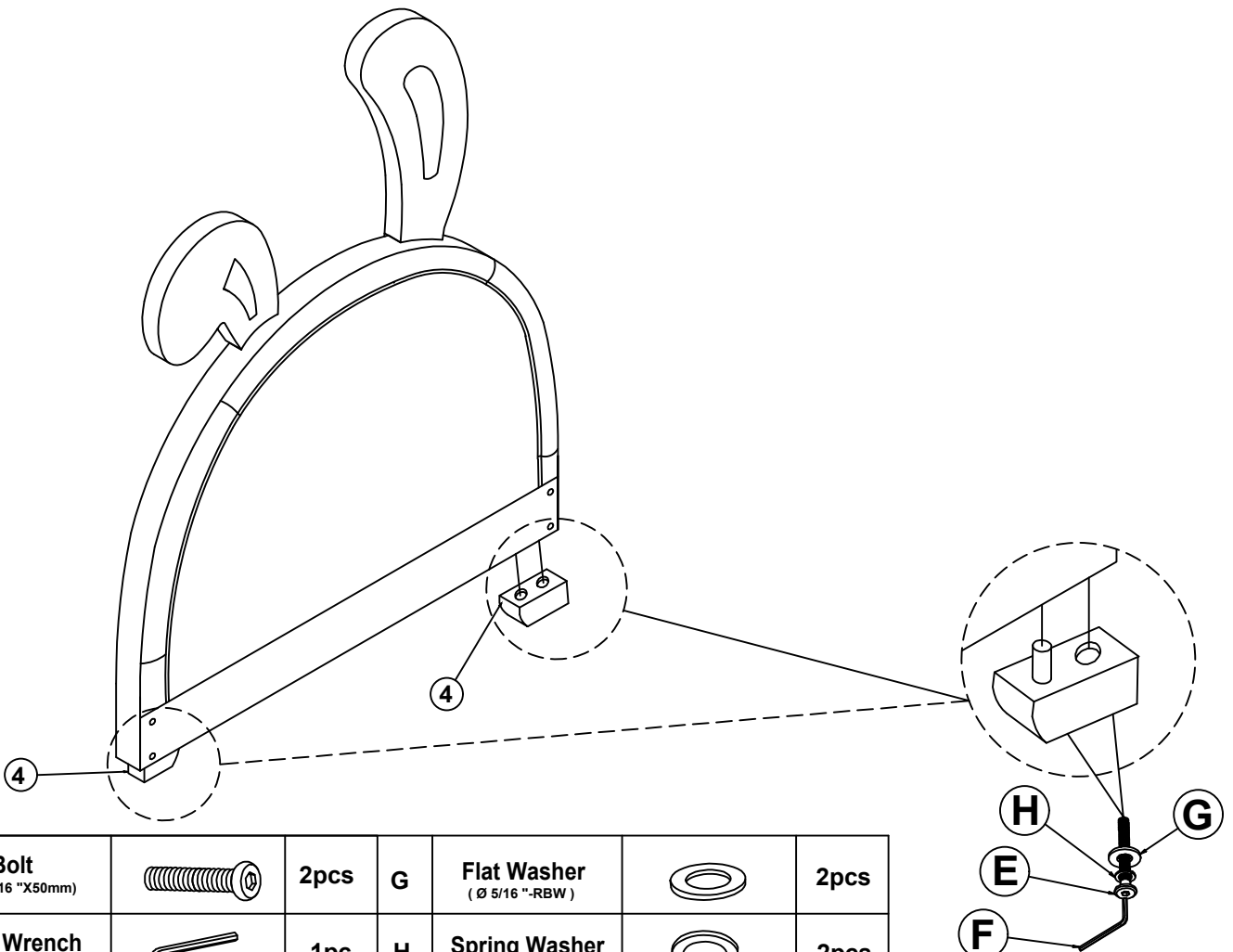

B	Bolt (Ø 5/16 "X32mm)		6pcs	G	Flat Washer (Ø 5/16 "-RBW)		6pcs
F	Allen Wrench (M4x75mm x32mm)		1pc	H	Spring Washer (Ø 5/16 "-RBW)		6pcs

STEP 2





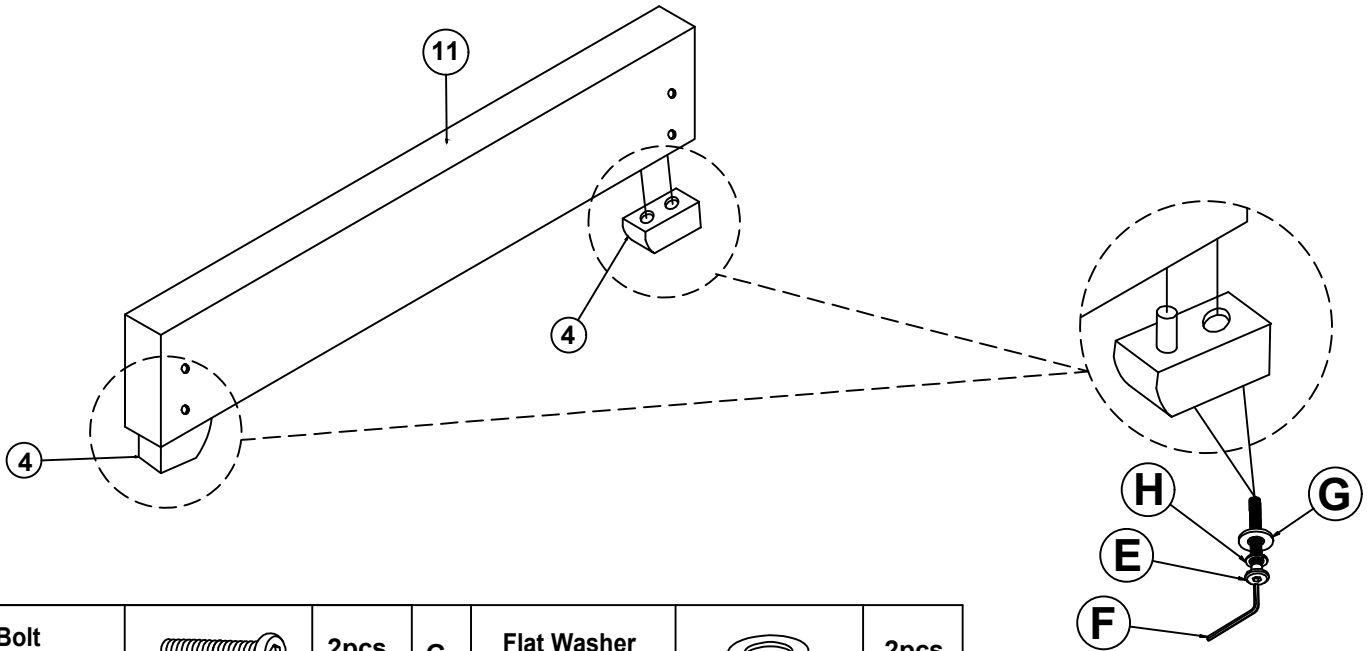

E	Bolt (Ø 5/16 "X50mm)		2pcs	G	Flat Washer (Ø 5/16 "-RBW)		2pcs
F	Allen Wrench (M4x75mm x32mm)		1pc	H	Spring Washer (Ø 5/16 "-RBW)		2pcs

ASSEMBLY INSTRUCTIONS





STEP 3

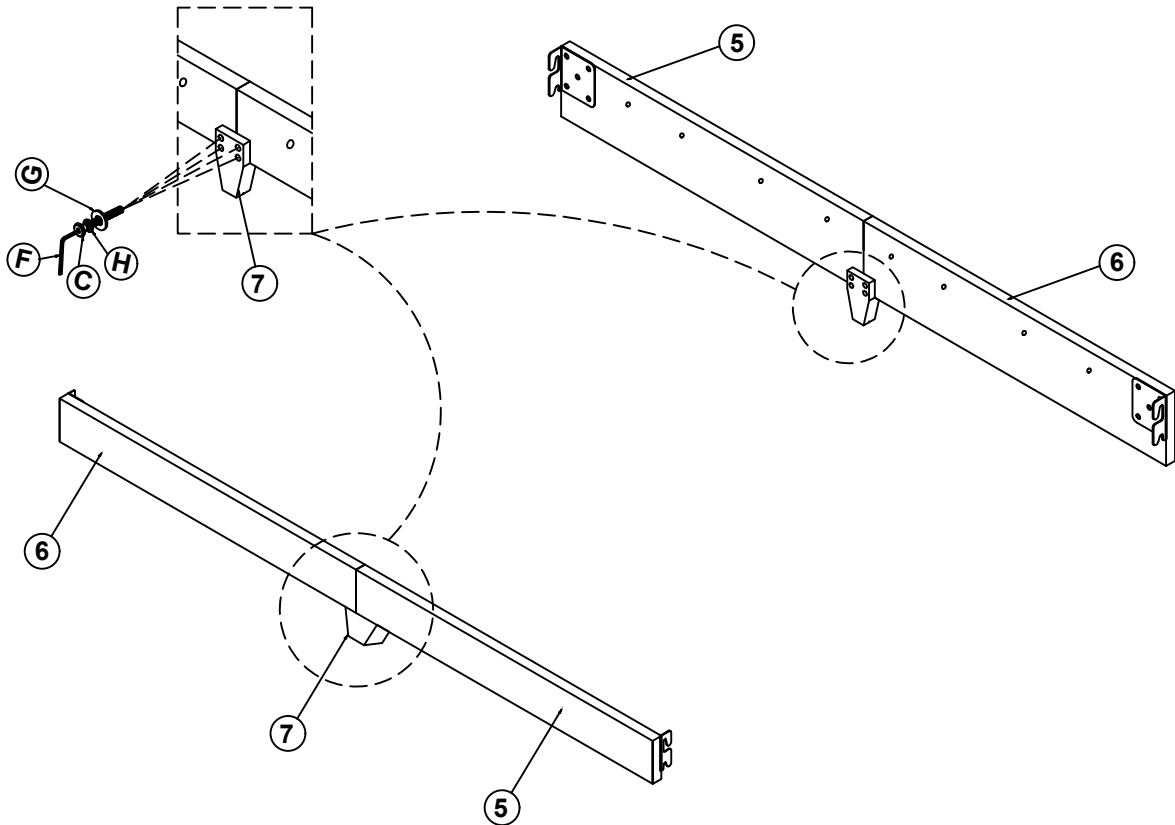

E	Bolt (Ø 5/16 "X50mm)		2pcs	G	Flat Washer (Ø 5/16 "-RBW)		2pcs
F	Allen Wrench (M4x75mm x32mm)		1pc	H	Spring Washer (Ø 5/16 "-RBW)		2pcs

STEP 4





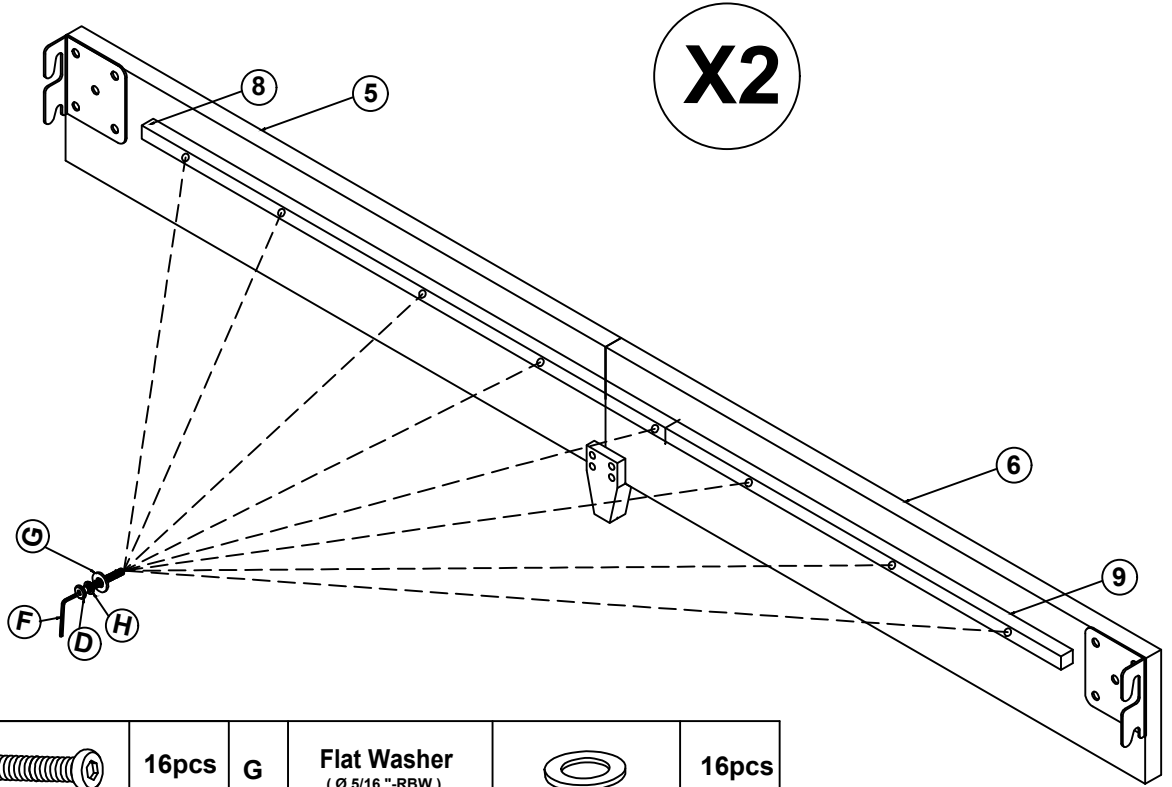

C	Bolt (Ø 5/16 "X38mm)		8pcs	G	Flat Washer (Ø 5/16 "-RBW)		8pcs
F	Allen Wrench (M4x75mm x32mm)		1pc	H	Spring Washer (Ø 5/16 "-RBW)		8pcs

ASSEMBLY INSTRUCTIONS





STEP 5

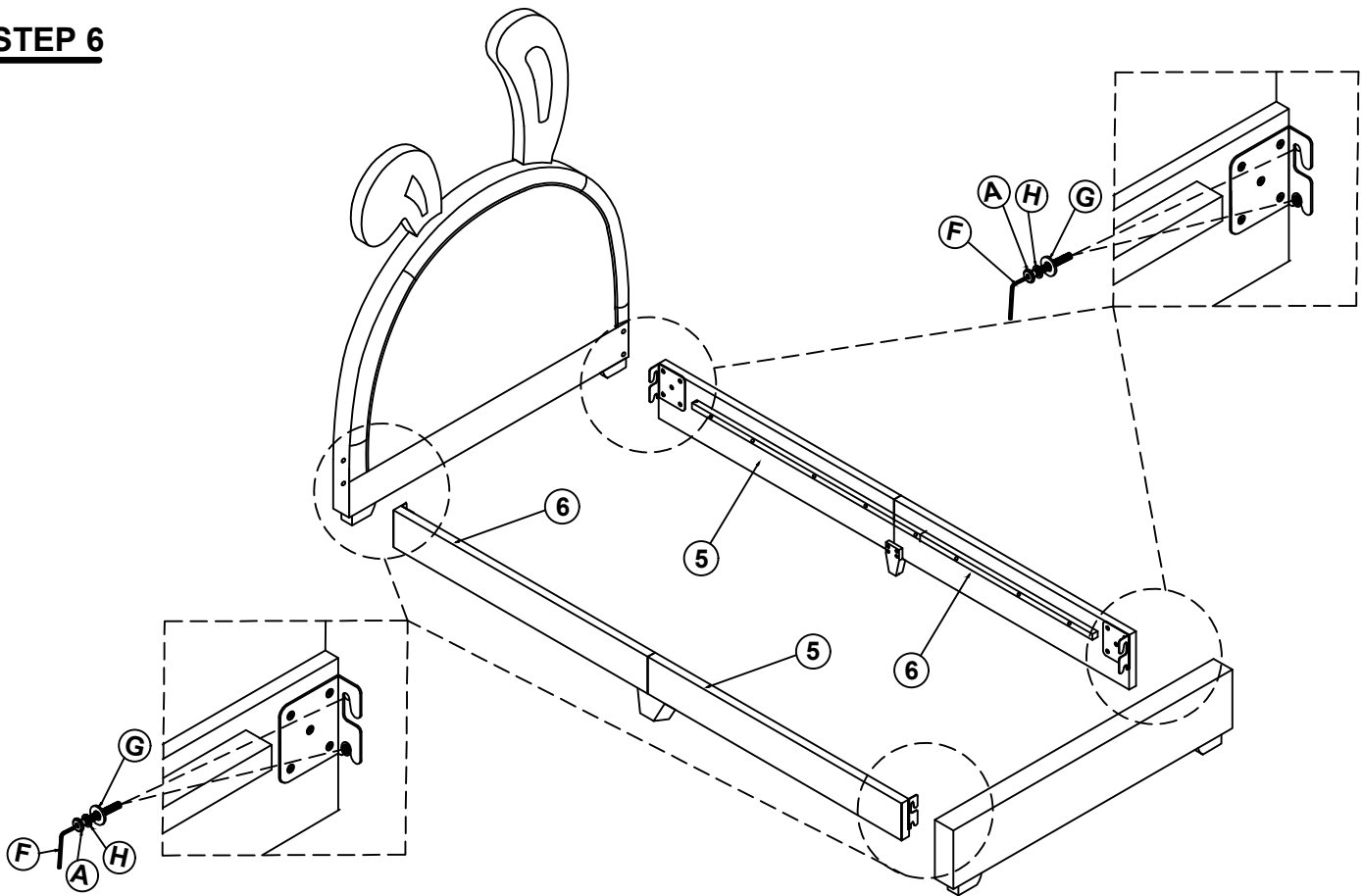

D	Bolt (Ø 5/16 "X45mm)		16pcs	G	Flat Washer (Ø 5/16 "-RBW)		16pcs
F	Allen Wrench (M4x75mm x32mm)		1pc	H	Spring Washer (Ø 5/16 "-RBW)		16pcs

STEP 6



A	Bolt (Ø 5/16 "X25mm)		8pcs	G	Flat Washer (Ø 5/16 "-RBW)		8pcs
F	Allen Wrench (M4x75mm x32mm)		1pc	H	Spring Washer (Ø 5/16 "-RBW)		8pcs

ASSEMBLY INSTRUCTIONS

STEP 7

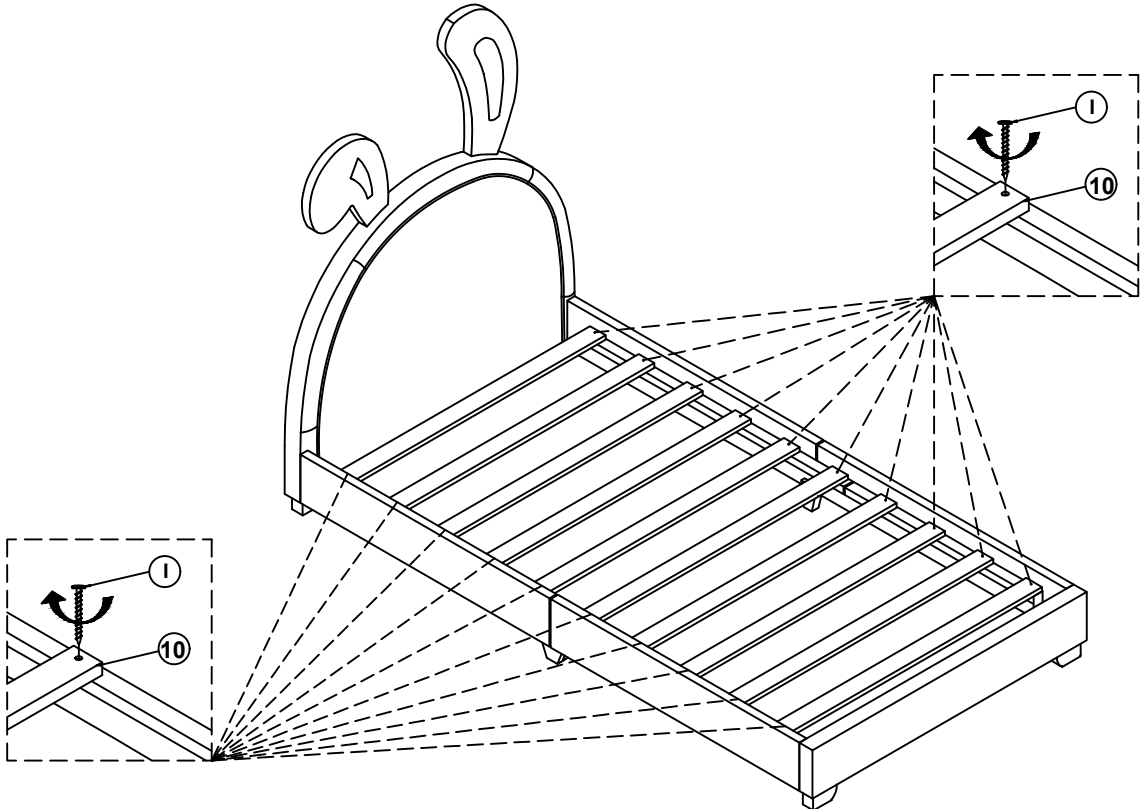

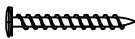
1	Flat Head Screw (m4x30mm-RBW)		20pcs
---	----------------------------------	---	-------

STEP 8 **COMPLETE**

