

# ASSEMBLY INSTRUCTIONS

WF 299139

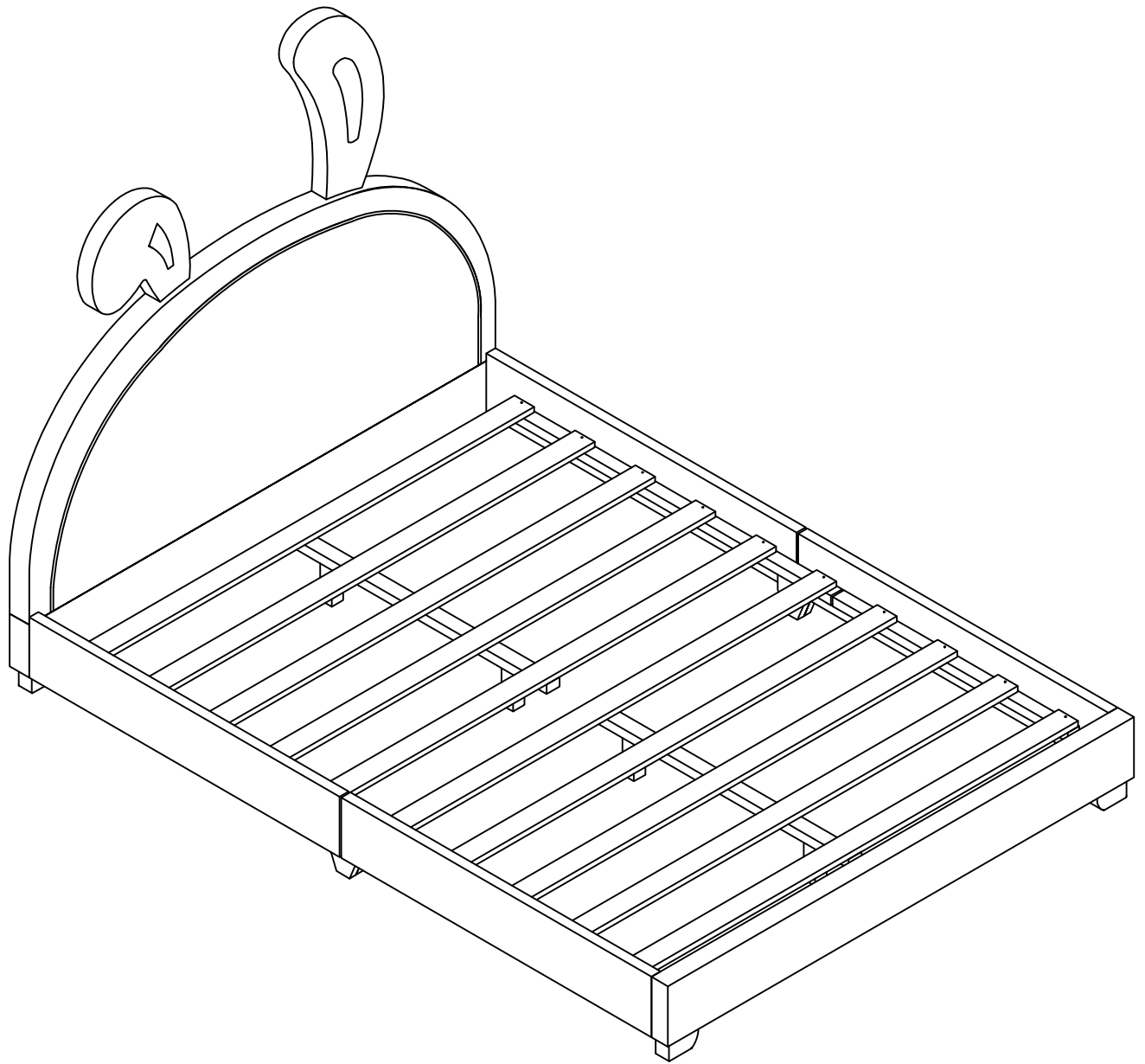









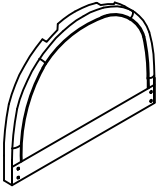

## IMPORTANT NOTE

- \*\*PLACE ALL PARTS ON A CLEAN AND SMOOTH SURFACE SUCH AS A RUG OR CARPET TO AVOID THE PARTS FROM BEING SCRATCHED**
- \*\* BEFORE YOU BEGIN , KINDY FOLLOW THE ASSEMBLY INSTRUCTIONS STEP BY STEP**
- \*\*DO NOT TIGHTEN ALL SCREWS AND BOLTS UNTIL THE BED IS FULLY SET-UP**

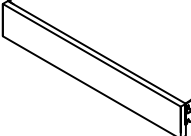
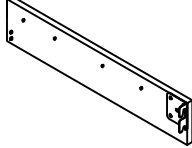
# ASSEMBLY INSTRUCTION

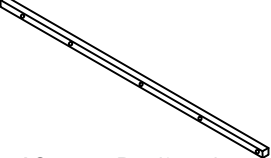
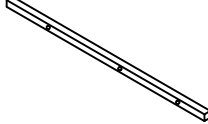

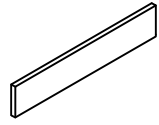
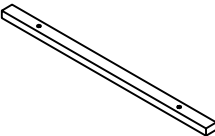

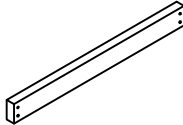
WF 299139

## PART LIST BOX 1: WF 299139

<p>1</p>  <p>Headboard Panel (1 pc)</p>	<p>2</p>  <p>Left Headboard Ear (1 pc)</p>	<p>3</p>  <p>Right Headboard Ear (1 pc)</p>
<p>4</p>  <p>Leg (4 pcs)</p>	<p>5</p>  <p>Side Front Rail (2 pcs)</p>	<p>6</p>  <p>Side Back Rail (2 pcs)</p>
<p>7</p>  <p>Rail Support Legs (2 pcs)</p>	<p>8</p>  <p>Bed Support Bar (2 pcs)</p>	<p>9</p>  <p>Bed Support Bar (2 pcs)</p>
<p>10</p>  <p>Roll Slat (10 pcs) 985*60*15</p>	<p>11</p>  <p>Footboard Panel (1 pc)</p>	<p>12</p>  <p>Center Rail (2 pcs)</p>
<p>13</p>  <p>Bed Slat Support With Leveler (4 pcs)</p>	<p>14</p>  <p>Bedside Junction Box (1 pc)</p>	

# ASSEMBLY INSTRUCTIONS

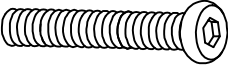
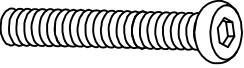

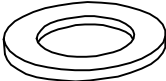
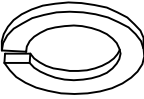
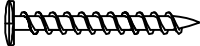

## HARDWARE LIST IN WF 299139

<p><b>A</b></p>  <p><b>Short Bolt (8pcs)</b> (Ø 5/16 "X25mm)</p>	<p><b>B</b></p>  <p><b>Long Bolt (6 pcs)</b> (Ø 5/16 "X32mm)</p>	<p><b>C</b></p>  <p><b>Long Bolt (8 pcs)</b> (Ø 5/16 "X38mm)</p>
<p><b>D</b></p>  <p><b>Long Bolt (20pcs)</b> (Ø 5/16 "X45mm)</p>	<p><b>E</b></p>  <p><b>Long Bolt (4pcs)</b> (Ø 5/16 "X50mm)</p>	<p><b>F</b></p>  <p><b>Allen Wrench (1 pc)</b> (M4x75mm x32mm)</p>
<p><b>G</b></p>  <p><b>Flat Washer (42 pcs)</b> (Ø 5/16 "-RBW)</p>	<p><b>H</b></p>  <p><b>Spring Washer (42 pcs)</b> (Ø 5/16 "-RBW)</p>	<p><b>I</b></p>  <p><b>Flat Head Screw (24 pcs)</b> (m4x30mm-RBW)</p>

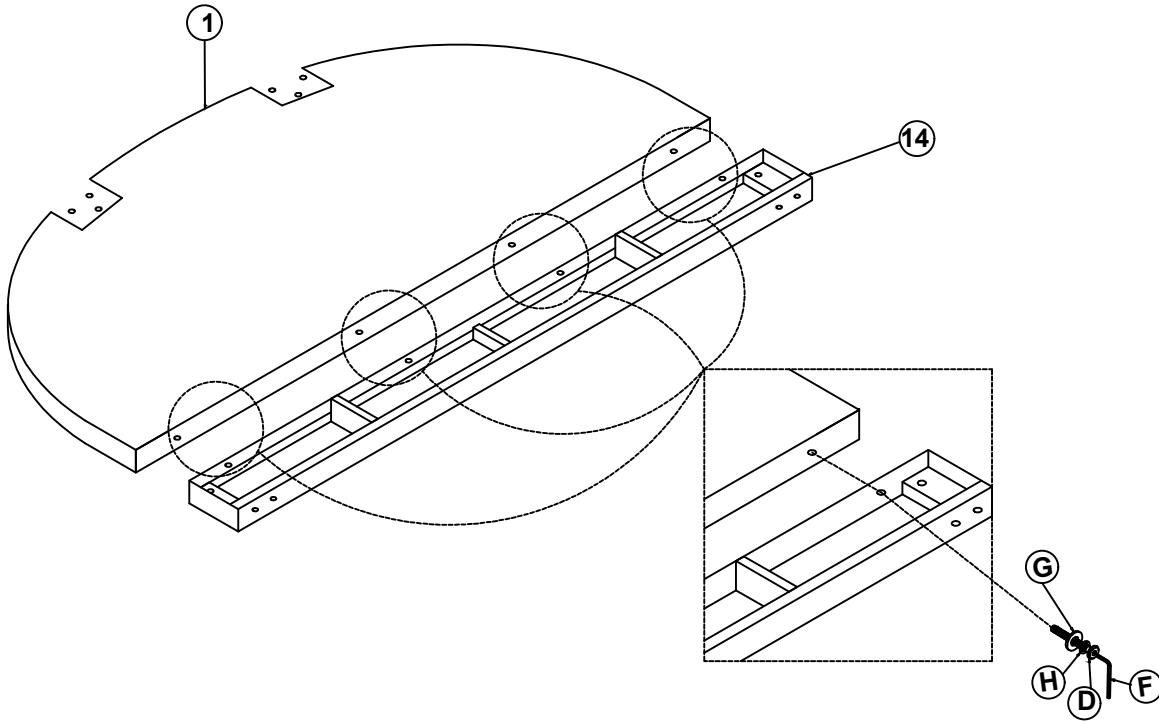
# ASSEMBLY INSTRUCTIONS





## STEP 1

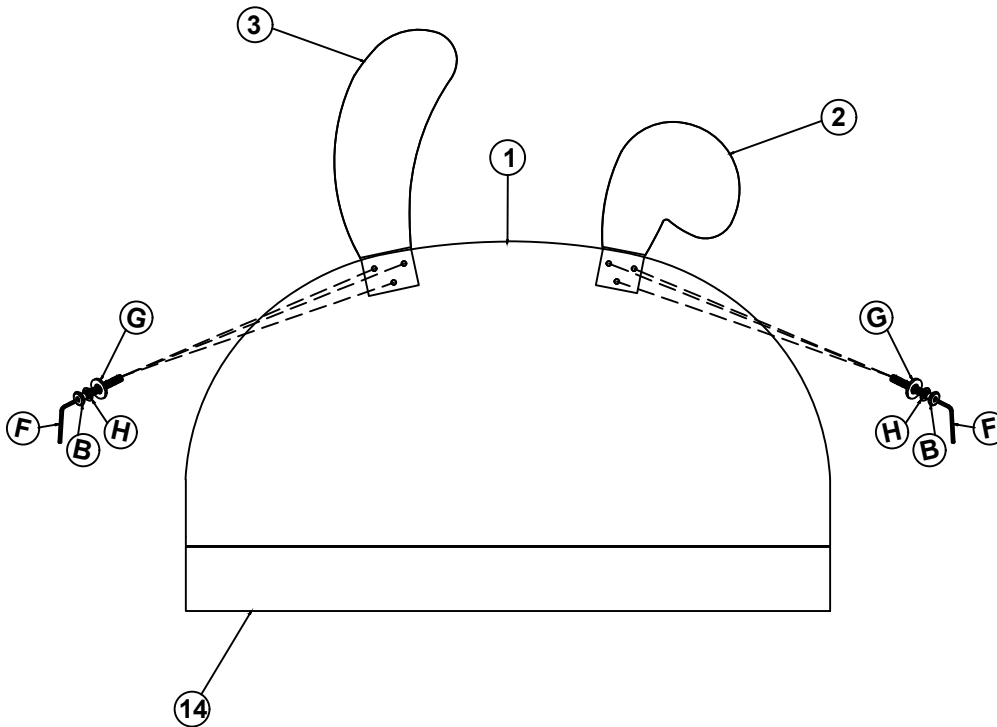

D	<b>Bolt</b> (Ø 5/16 "X45mm)		4pcs	G	<b>Flat Washer</b> (Ø 5/16 "-RBW)		4pcs
F	<b>Allen Wrench</b> (M4x75mm x32mm)		1pc	H	<b>Spring Washer</b> (Ø 5/16 "-RBW)		4pcs

## STEP 2





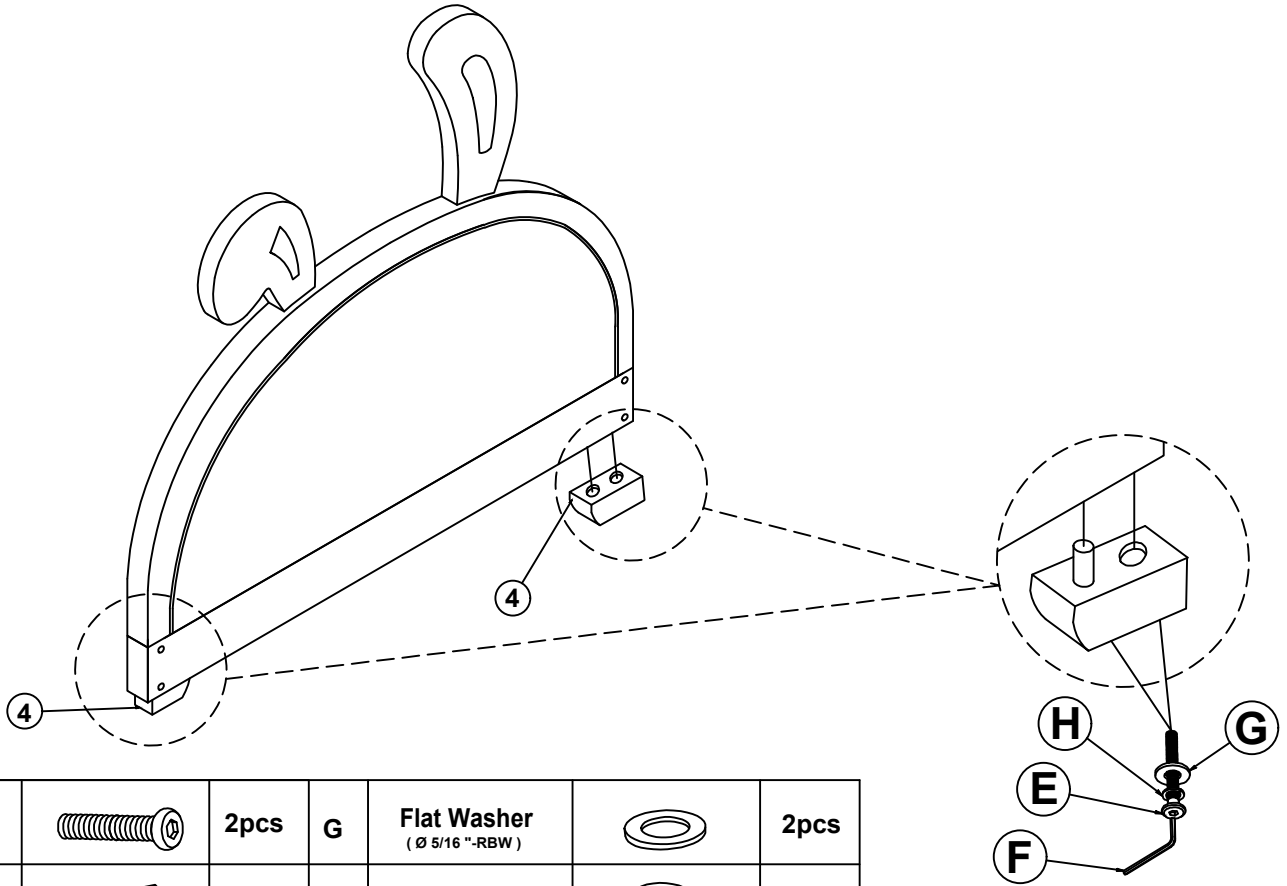

B	<b>Bolt</b> (Ø 5/16 "X32mm)		6pcs	G	<b>Flat Washer</b> (Ø 5/16 "-RBW)		6pcs
F	<b>Allen Wrench</b> (M4x75mm x32mm)		1pc	H	<b>Spring Washer</b> (Ø 5/16 "-RBW)		6pcs

# ASSEMBLY INSTRUCTIONS





## STEP 3

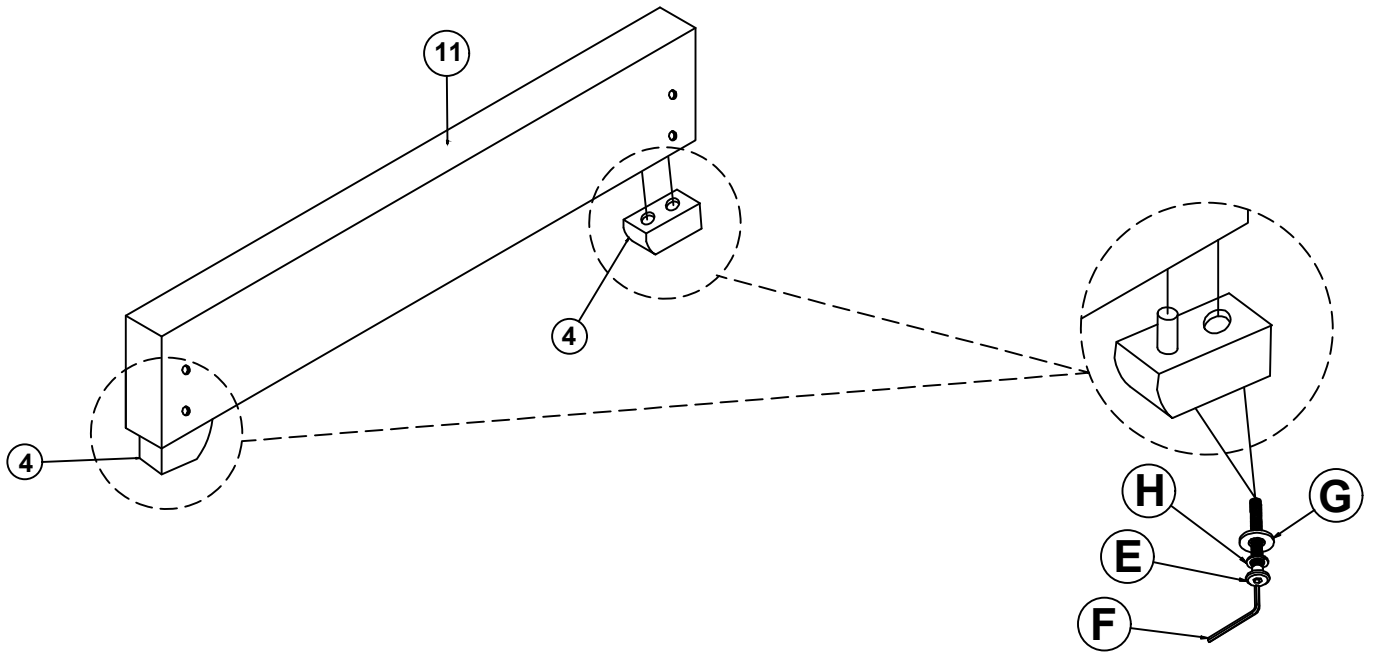

E	<b>Bolt</b> (Ø 5/16 "X50mm)		2pcs	G	<b>Flat Washer</b> (Ø 5/16 "-RBW)		2pcs
F	<b>Allen Wrench</b> (M4x75mm x32mm)		1pc	H	<b>Spring Washer</b> (Ø 5/16 "-RBW)		2pcs

## STEP 4





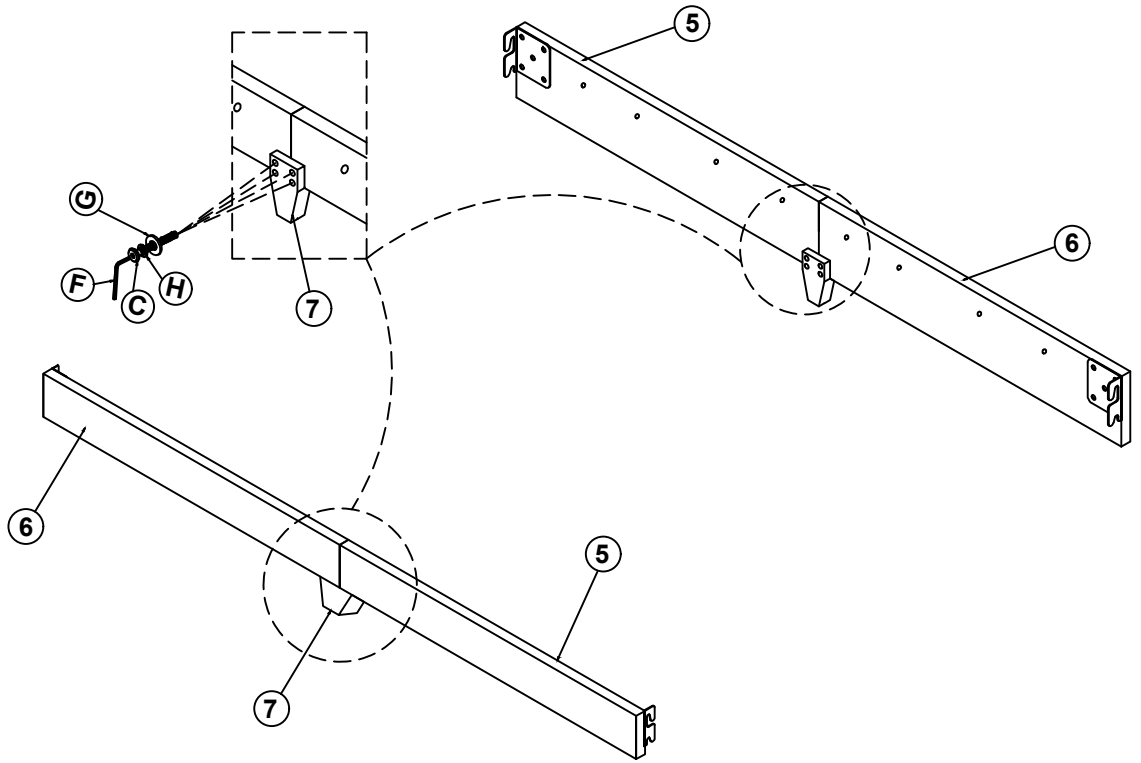

E	<b>Bolt</b> (Ø 5/16 "X50mm)		2pcs	G	<b>Flat Washer</b> (Ø 5/16 "-RBW)		2pcs
F	<b>Allen Wrench</b> (M4x75mm x32mm)		1pc	H	<b>Spring Washer</b> (Ø 5/16 "-RBW)		2pcs

# ASSEMBLY INSTRUCTIONS





## STEP 5

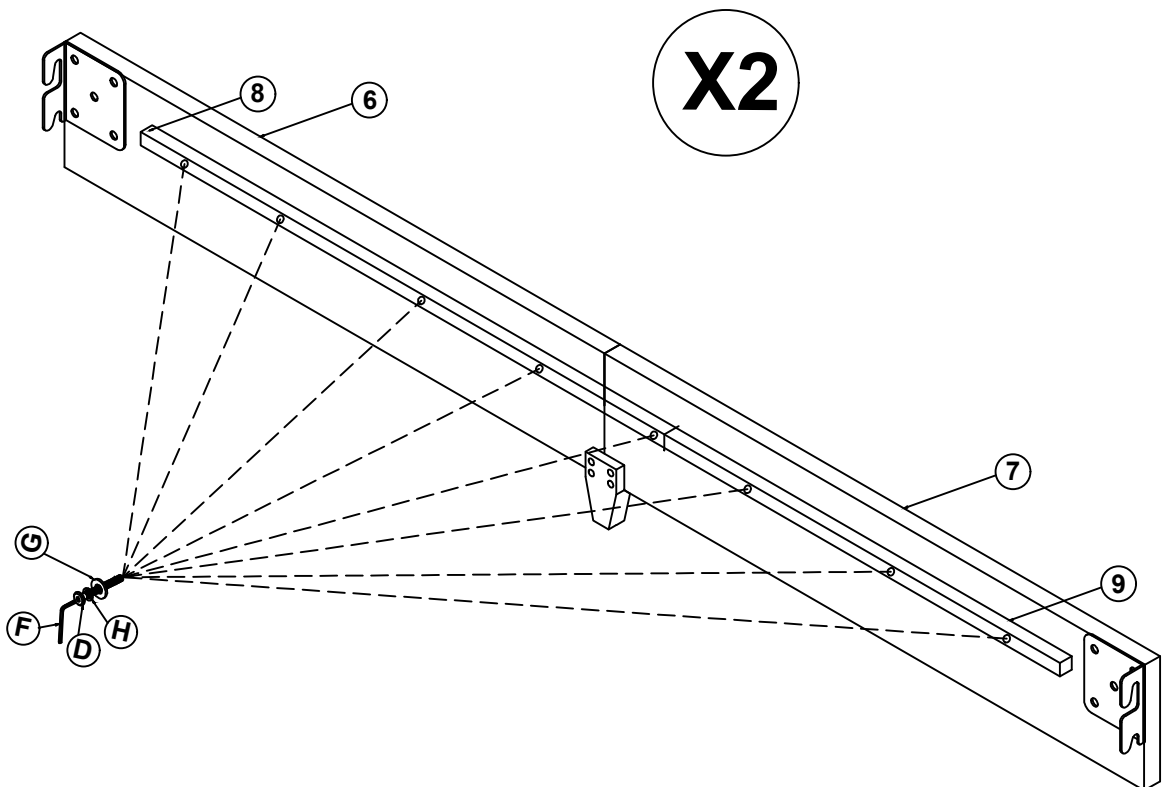

C	<b>Bolt</b> (Ø 5/16 "X38mm)		8pcs	G	<b>Flat Washer</b> (Ø 5/16 "-RBW)		8pcs
F	<b>Allen Wrench</b> (M4x75mm x32mm)		1pc	H	<b>Spring Washer</b> (Ø 5/16 "-RBW)		8pcs

## STEP 6





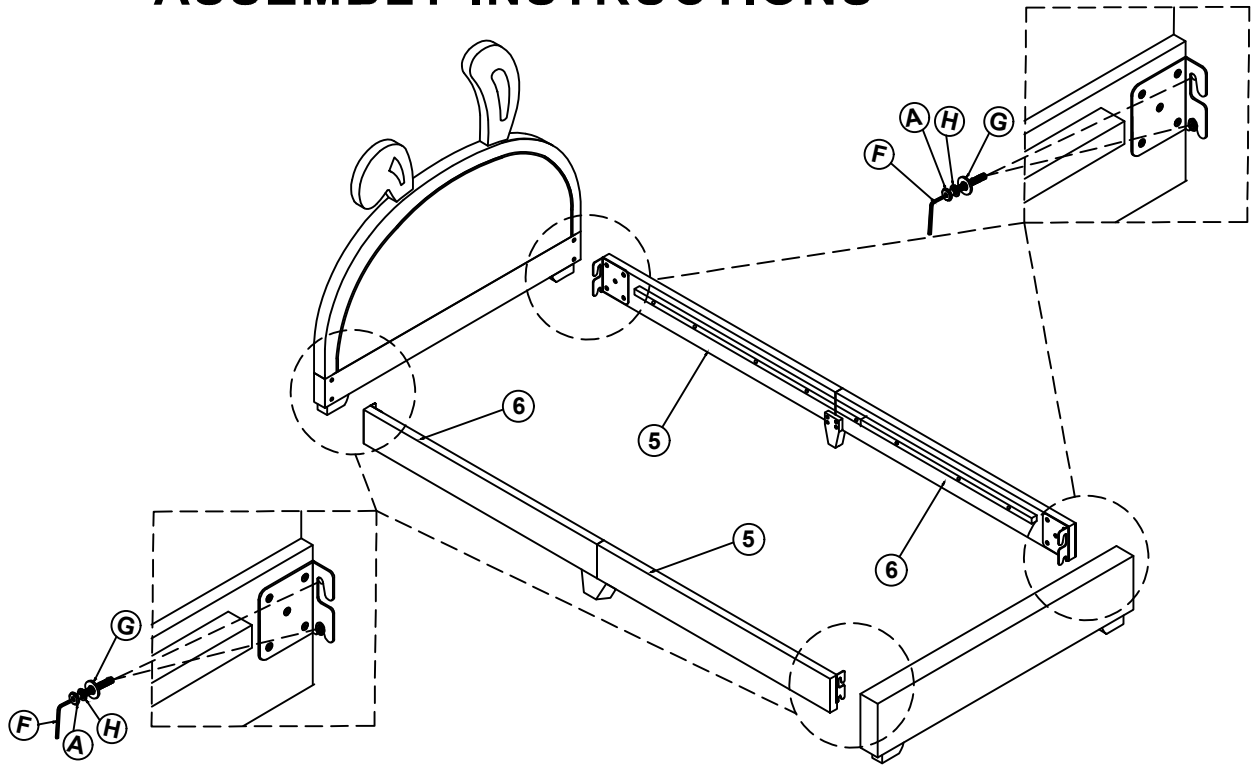

D	<b>Bolt</b> (Ø 5/16 "X45mm)		16pcs	G	<b>Flat Washer</b> (Ø 5/16 "-RBW)		16pcs
F	<b>Allen Wrench</b> (M4x75mm x32mm)		1pc	H	<b>Spring Washer</b> (Ø 5/16 "-RBW)		16pcs

# ASSEMBLY INSTRUCTIONS

## STEP 7



A	<b>Bolt</b> (Ø 5/16 "X25mm)		8pcs	G	<b>Flat Washer</b> (Ø 5/16 "-RBW)		8pcs
F	<b>Allen Wrench</b> (M4x75mm x32mm)		1pc	H	<b>Spring Washer</b> (Ø 5/16 "-RBW)		8pcs

## STEP 8

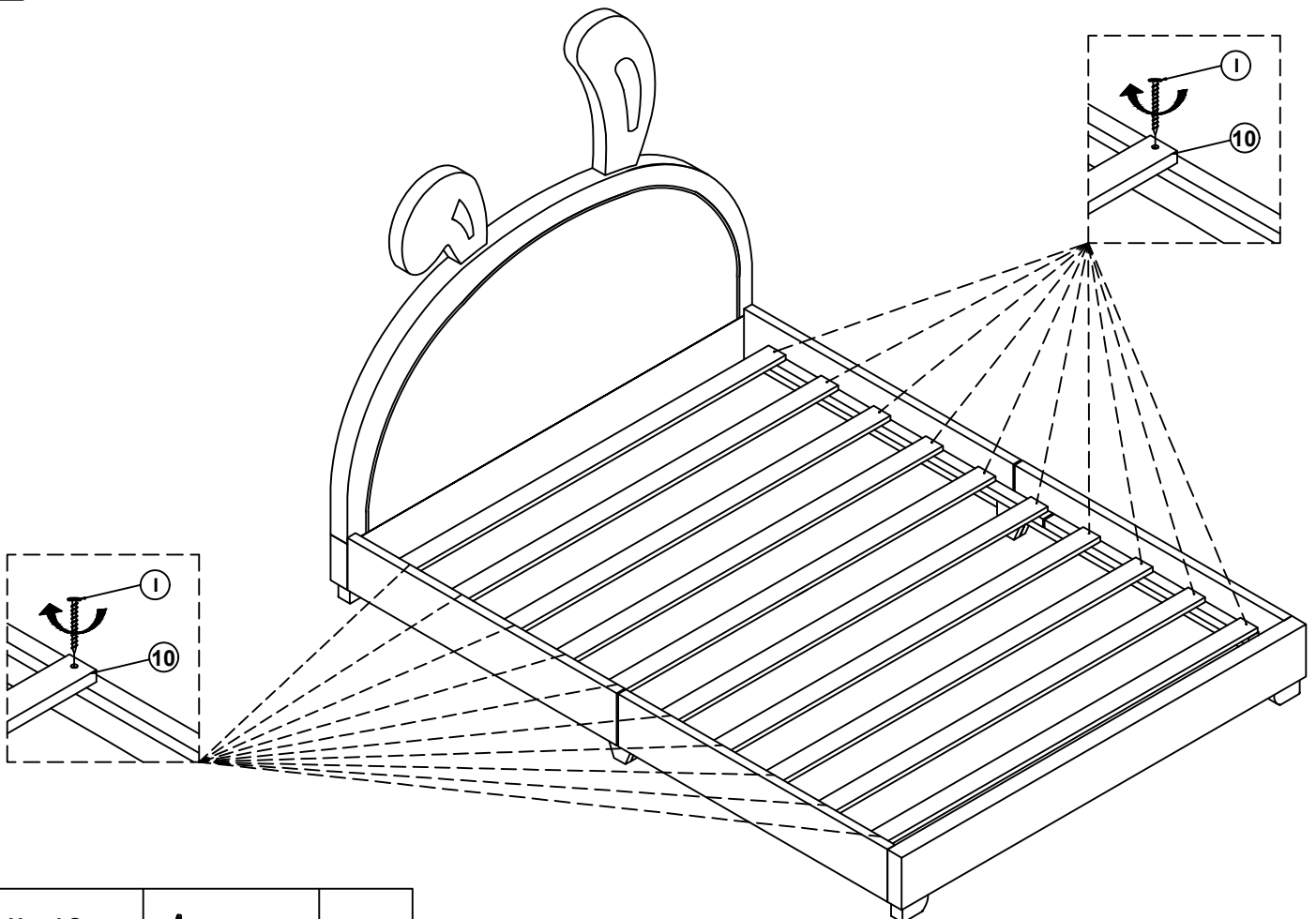

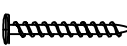
I	<b>Flat Head Screw</b> (m4x30mm-RBW)		20pcs
---	---	---	-------

# ASSEMBLY INSTRUCTIONS

## STEP 9

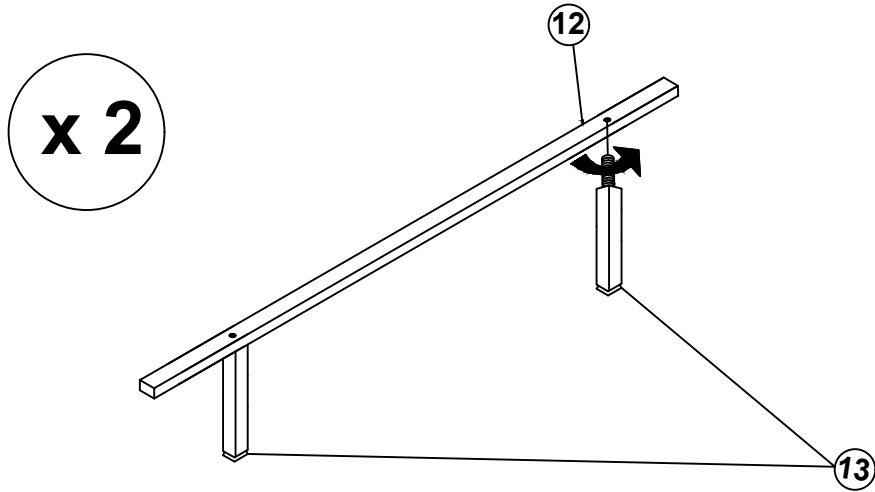

## STEP 10

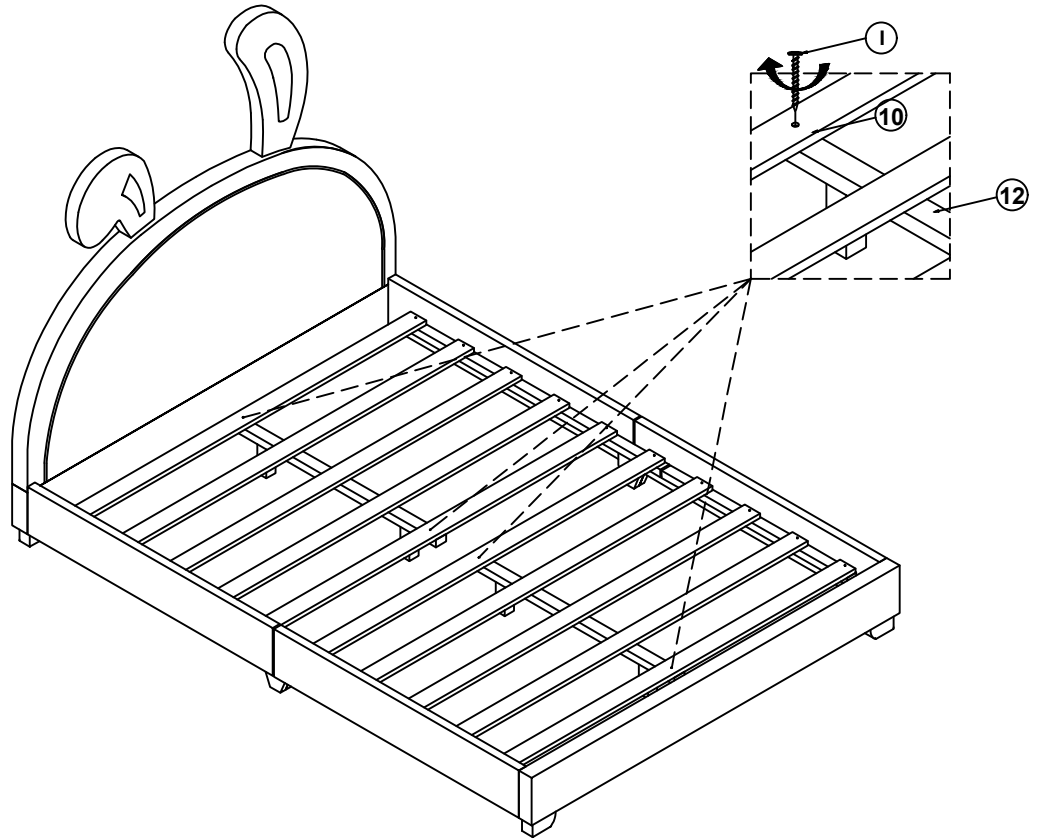

1	Flat Head Screw (m4x30mm-RBW)		4pcs
---	----------------------------------	---	------



# ASSEMBLY INSTRUCTIONS

**STEP 11**  
**COMPLETE**

