

# ASSEMBLY INSTRUCTIONS

## TWIN HOUSE BED WITH TRUNDLE

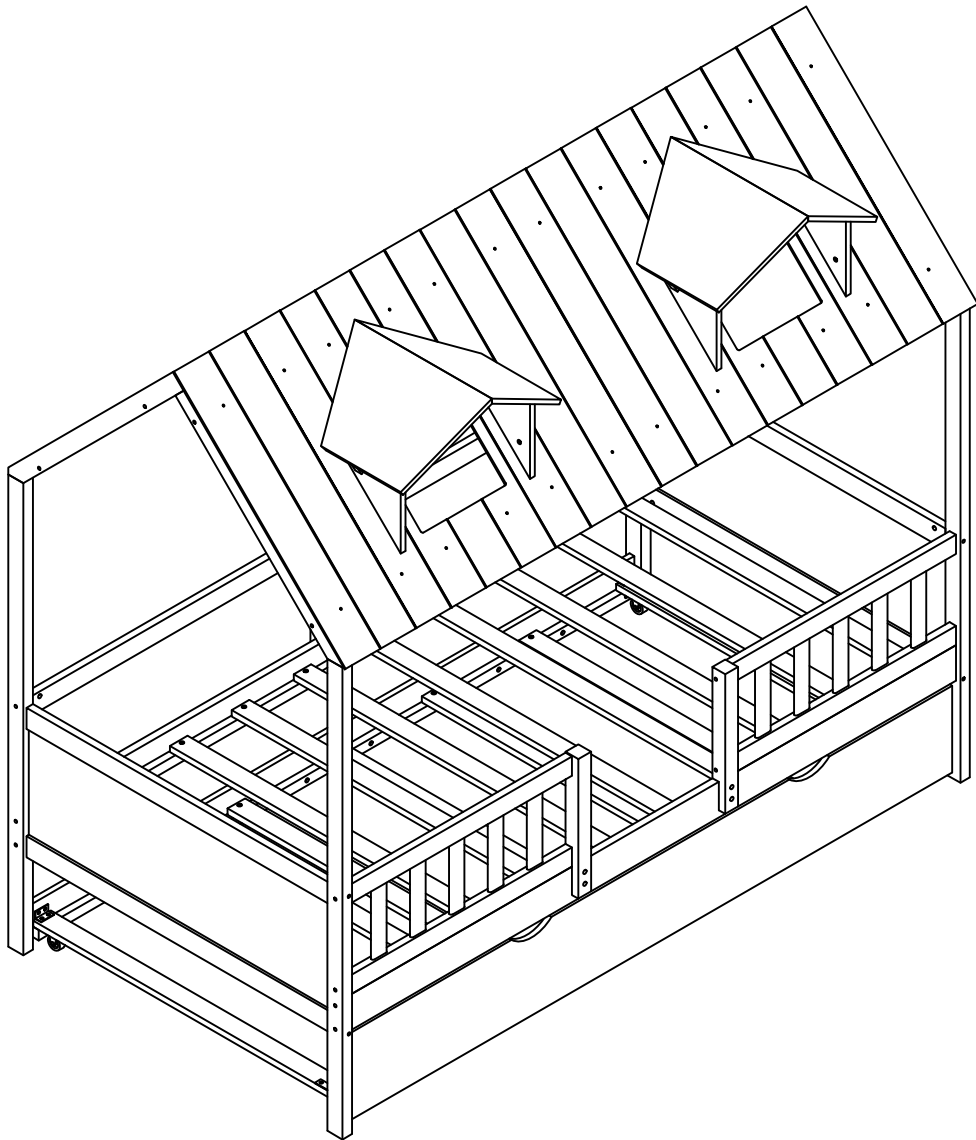











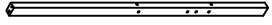
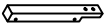
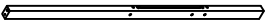
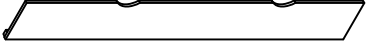

WF298172/WF298173

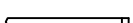

# ASSEMBLY INSTRUCTIONS

## PARTS LIST



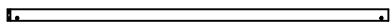



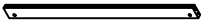
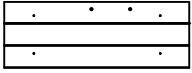
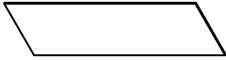
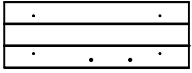
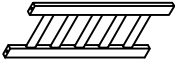

W298172

|           |  |     |           |  |      |
|-----------|--|-----|-----------|--|------|
| <b>1</b>  | Left front leg              | 1pc | <b>12</b> | Front guard rails support   | 2pcs |
| <b>2</b>  | Left back leg               | 1pc | <b>14</b> | Trundle front panel         | 1pc  |
| <b>3</b>  | Right back leg              | 1pc | <b>15</b> | Trundle back panel          | 1pc  |
| <b>4</b>  | Right front leg             | 1pc | <b>16</b> | Roof left front crossbar    | 1pc  |
| <b>7</b>  | Side rails                  | 1pc | <b>17</b> | Roof left back crossbar     | 1pc  |
| <b>8</b>  | Side rails                  | 1pc | <b>18</b> | Roof right front crossbar   | 1pc  |
| <b>9</b>  | Back guard rails          | 1pc | <b>19</b> | Roof right back crossbar  | 1pc  |
| <b>10</b> | Back guard rails support  | 1pc | <b>20</b> | Roof crossbar             | 4pcs |

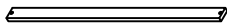

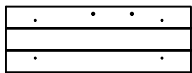

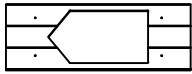









# ASSEMBLY INSTRUCTIONS

## PARTS LIST

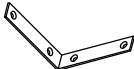
W298173

|           |                   |   |       |           |               |  |      |
|-----------|-------------------|---|-------|-----------|---------------|--|------|
| <b>5</b>  | Headboard panels  |    | 4pcs  | <b>24</b> | Roof panels   |   | 1pc  |
| <b>6</b>  | Head board frames |    | 2pcs  | <b>25</b> | Roof panels   |   | 1pc  |
| <b>11</b> | Front guard rails |    | 2pcs  | <b>26</b> | Window panels |   | 2pcs |
| <b>13</b> | Slats             |    | 17pcs | <b>27</b> | Window panels |   | 2pcs |
| <b>21</b> | Roof panels       |    | 1pc   | <b>28</b> | Window panels |   | 2pcs |
| <b>22</b> | Roof panels       |    | 2pcs  | <b>29</b> | Window panels |  | 2pcs |
| <b>23</b> | Roof panels       |  | 1pc   |           |               |  |      |

### HARDWARE LIST (WF298172)

|          |         |   |       |          |                                   |   |       |
|----------|---------|---|-------|----------|-----------------------------------|---|-------|
| <b>A</b> | Ø4x30   |  | 36PCS | <b>J</b> | 4x58                              |  | 1PC   |
| <b>B</b> | Ø4x20   |  | 24PCS | <b>K</b> | 6.5x90                            |  | 2PCS  |
| <b>C</b> | Ø4x15   |  | 32PCS | <b>L</b> | 6.5x60                            |  | 4PCS  |
| <b>D</b> | Ø3.5x12 |  | 16PCS | <b>M</b> | Ø10x40                            |  | 28PCS |
| <b>E</b> | 1/4x90  |  | 12PCS | <b>N</b> | 95x95x20                          |  | 2PCS  |
| <b>F</b> | 1/4x75  |  | 22PCS | <b>O</b> | 40x20x20                          |  | 2PCS  |
| <b>G</b> | 1/4x45  |  | 8PCS  | <b>P</b> | Ø38x46x38                         |  | 4PCS  |
| <b>H</b> | 1/4x35  |  | 4PCS  | <b>Q</b> | 15x15x2                           |  | 8PCS  |
|          |         |   |       |          | Phillip head screw<br>Not include |   |       |

# ASSEMBLY INSTRUCTIONS

## Step 1

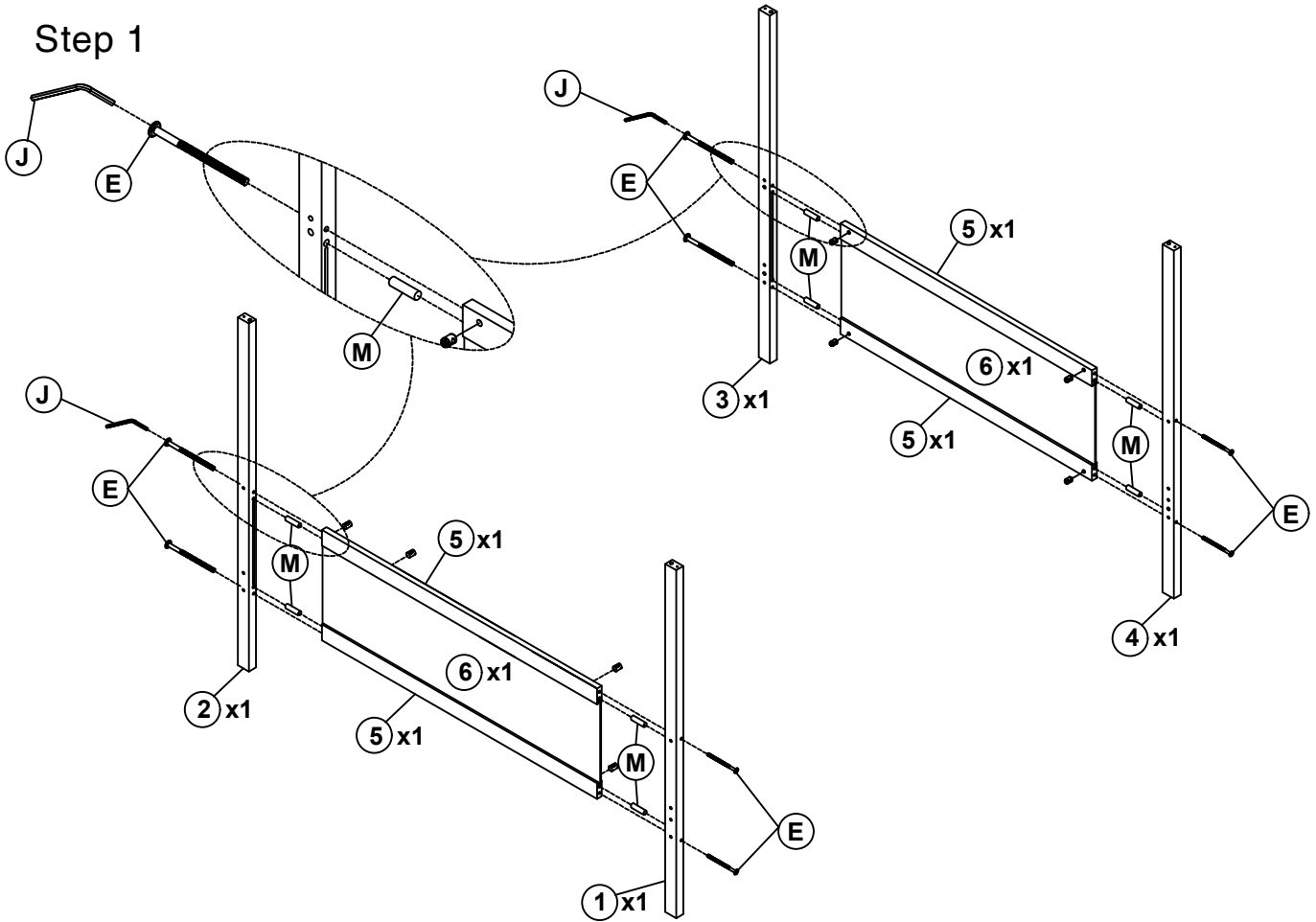

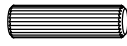

|          |        |   |      |
|----------|--------|---|------|
| <b>M</b> | Ø10x40 |  | 8PCS |
|----------|--------|---|------|

|          |        |   |      |
|----------|--------|---|------|
| <b>E</b> | 1/4x90 |  | 8PCS |
|----------|--------|---|------|

|          |      |   |     |
|----------|------|---|-----|
| <b>J</b> | 4x58 |  | 1PC |
|----------|------|---|-----|

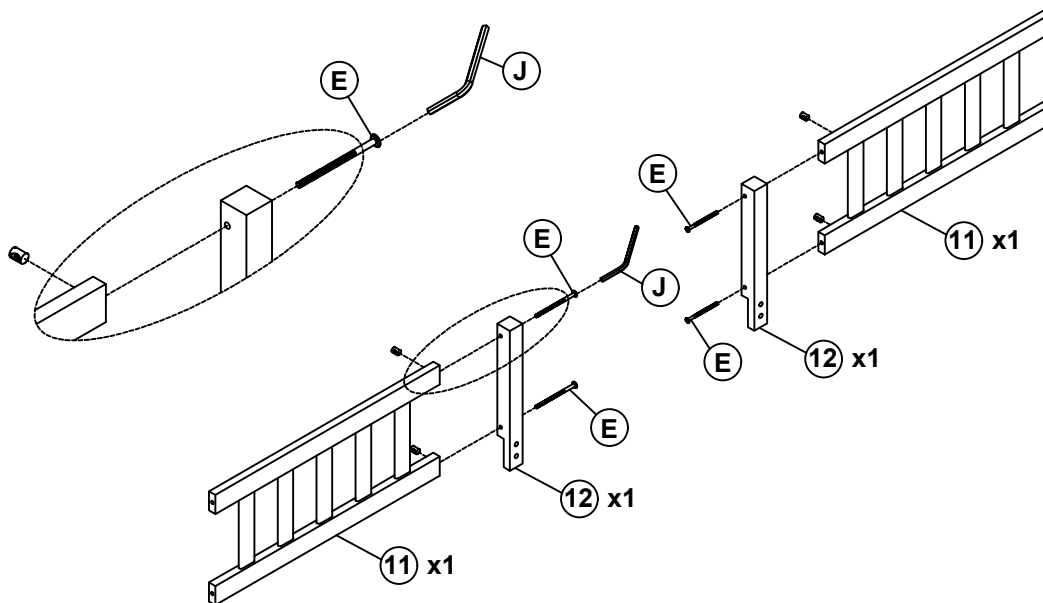
## Step 2







|          |        |   |      |
|----------|--------|---|------|
| <b>E</b> | 1/4x90 |  | 4PCS |
|----------|--------|---|------|

|          |      |   |     |
|----------|------|---|-----|
| <b>J</b> | 4x58 |  | 1PC |
|----------|------|---|-----|

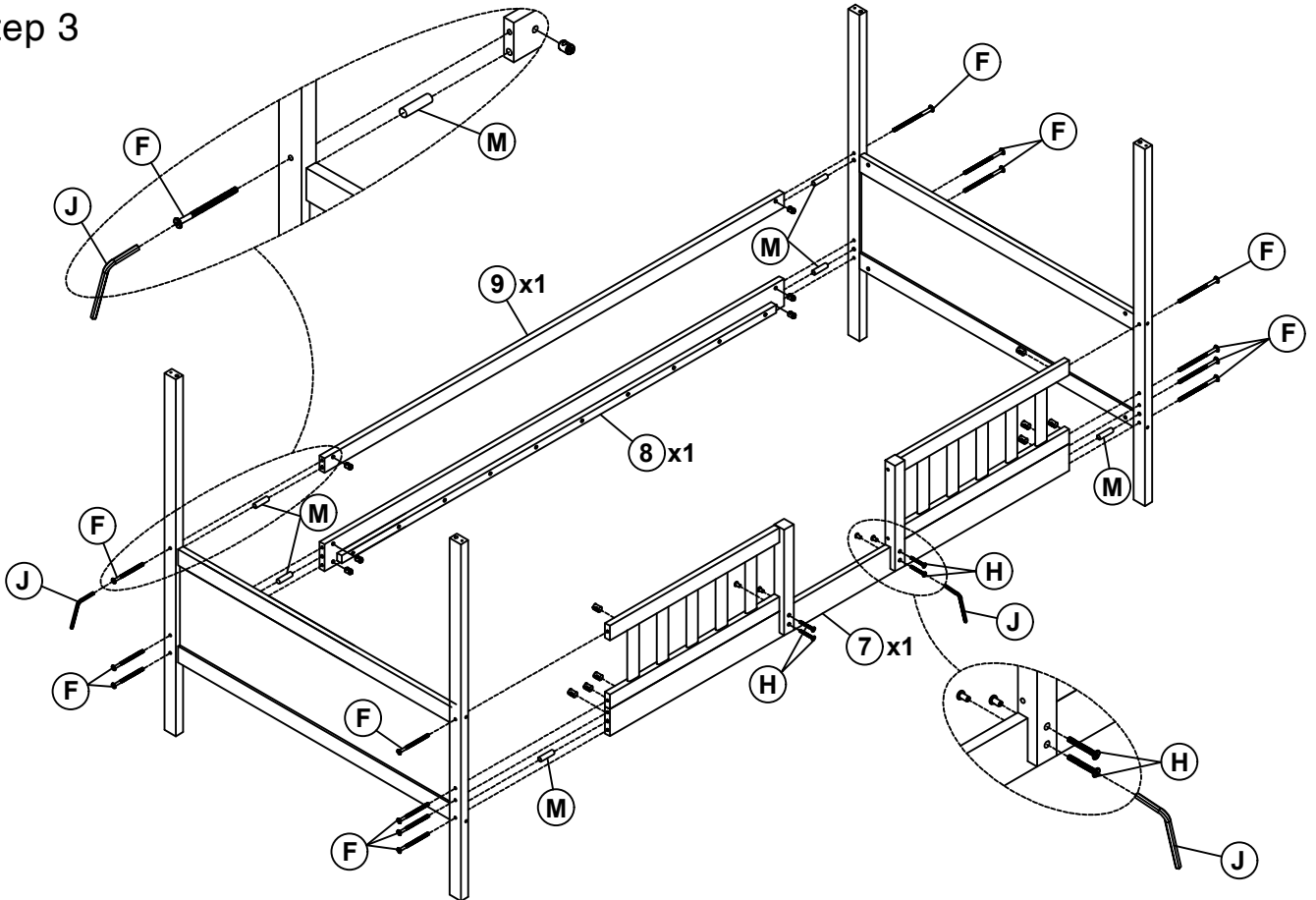
# ASSEMBLY INSTRUCTIONS

## Step 3

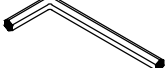

|          |        |   |       |          |        |   |      |
|----------|--------|---|-------|----------|--------|---|------|
| <b>F</b> | 1/4x75 |  | 14PCS | <b>M</b> | Ø10x40 |  | 6PCS |
| <b>H</b> | 1/4x35 |  | 4PCS  | <b>J</b> | 4x58   |  | 1PC  |

## Step 4

First attach 2pcs part 13 to the front and end of the frame, between side rails. Then attach the remaining part 13 equidistantly between side rails.

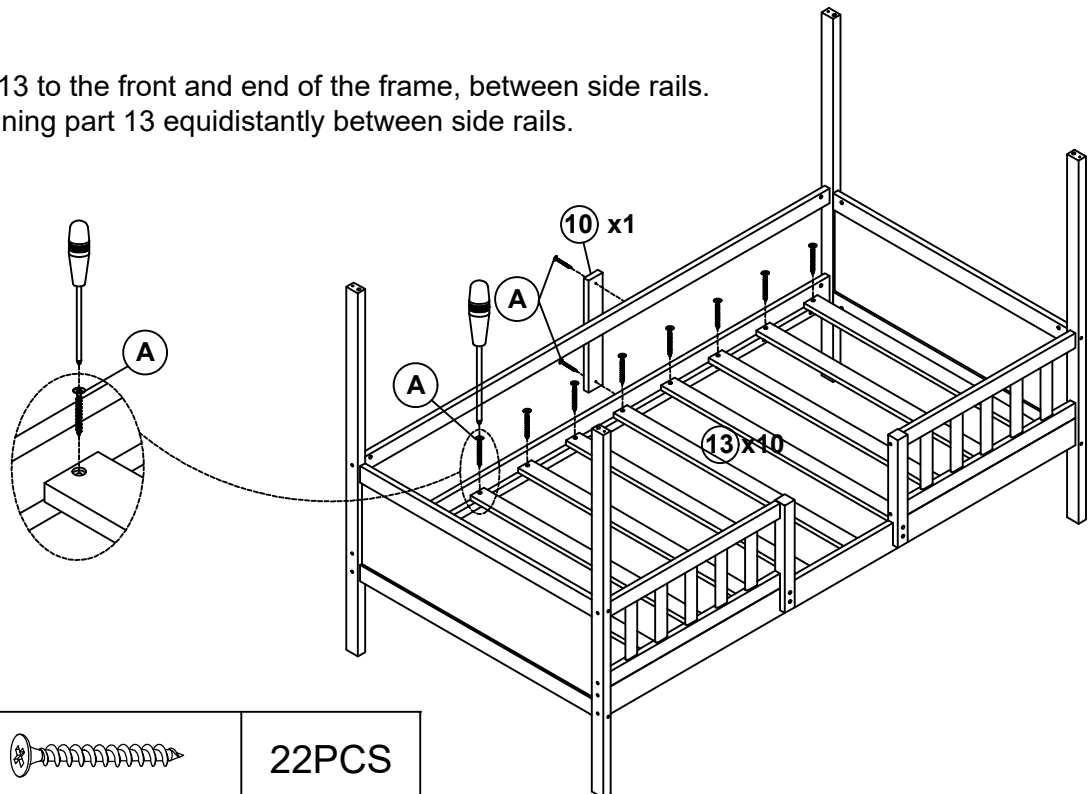



|          |       |   |       |
|----------|-------|---|-------|
| <b>A</b> | Ø4x30 |  | 22PCS |
|----------|-------|---|-------|

# ASSEMBLY INSTRUCTIONS

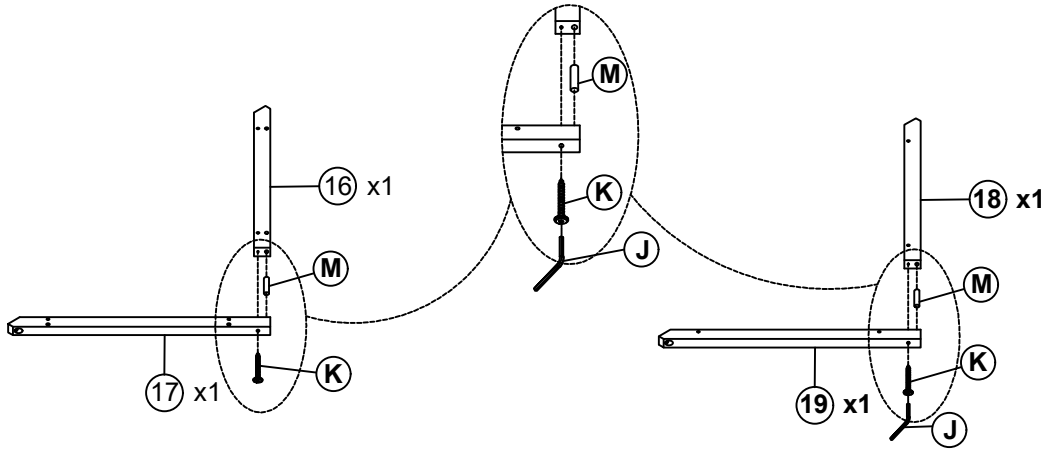

## Step 5

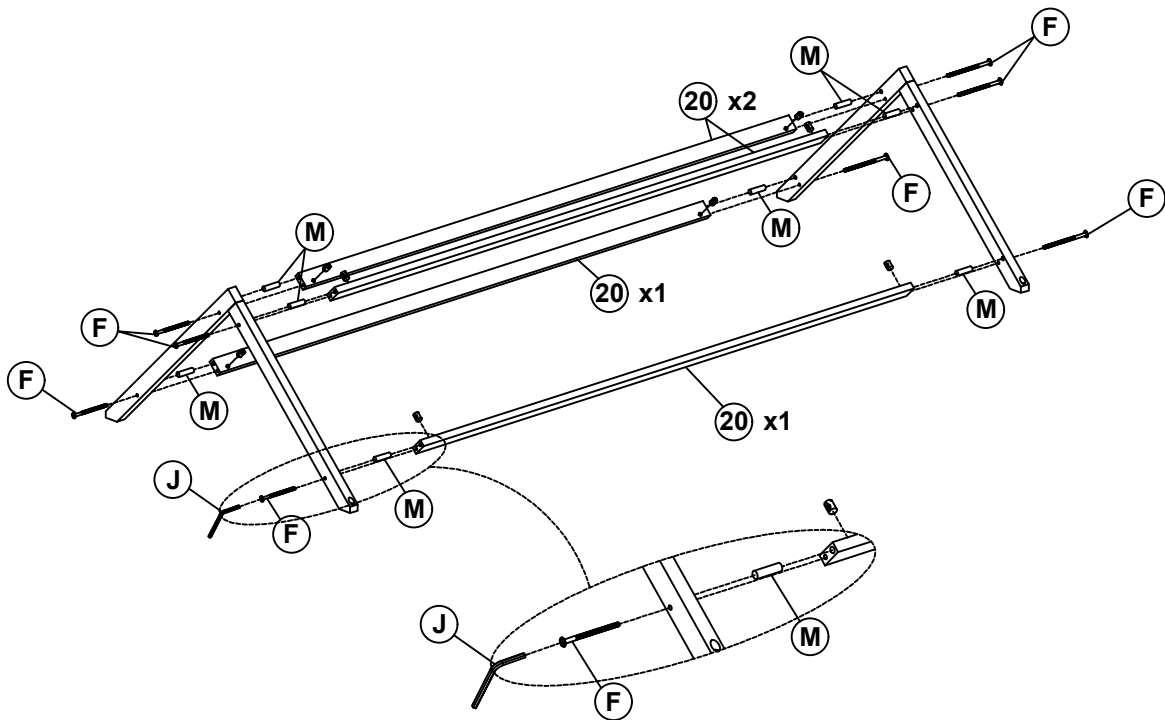

|          |        |   |      |          |        |   |      |
|----------|--------|---|------|----------|--------|---|------|
|          |        |   |      | <b>K</b> | 6.5x90 |  | 2PCS |
| <b>M</b> | Ø10x40 |  | 2PCS | <b>J</b> | 4x58   |  | 1PC  |

## Step 6





|          |        |   |      |          |        |   |      |
|----------|--------|---|------|----------|--------|---|------|
|          |        |   |      | <b>F</b> | 1/4x75 |  | 8PCS |
| <b>M</b> | Ø10x40 |  | 8PCS | <b>J</b> | 4x58   |  | 1PC  |

# ASSEMBLY INSTRUCTIONS

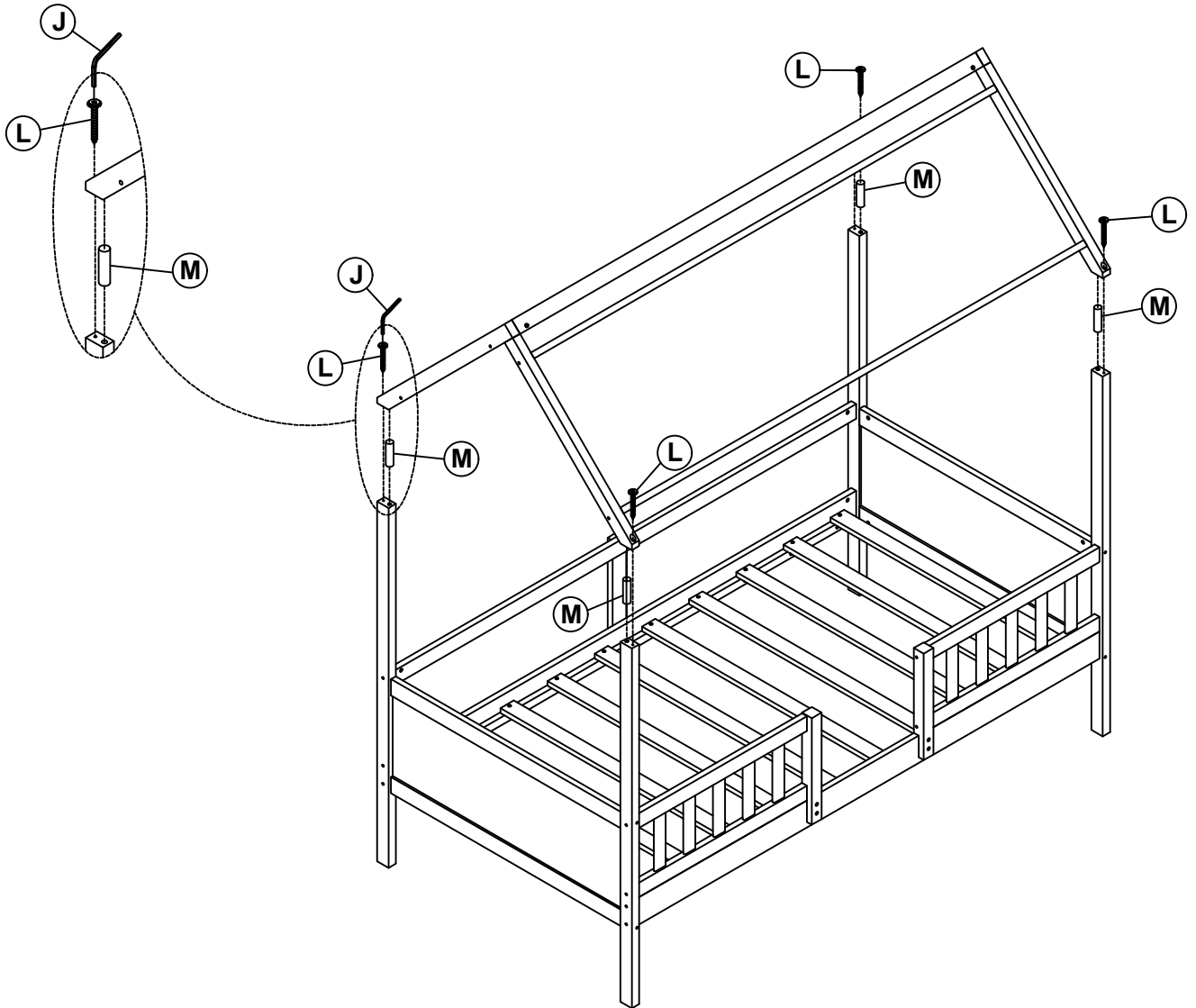
## Step 7



|          |        |   |      |          |      |   |
|----------|--------|---|------|----------|------|---|
| <b>L</b> | 6.5x60 |  | 4PCS |          |      |   |
| <b>M</b> | Ø10x40 |  | 4PCS | <b>J</b> | 4x58 |  |
|          |        |   |      |          |      | 1PC   |



# ASSEMBLY INSTRUCTIONS

## Step 8

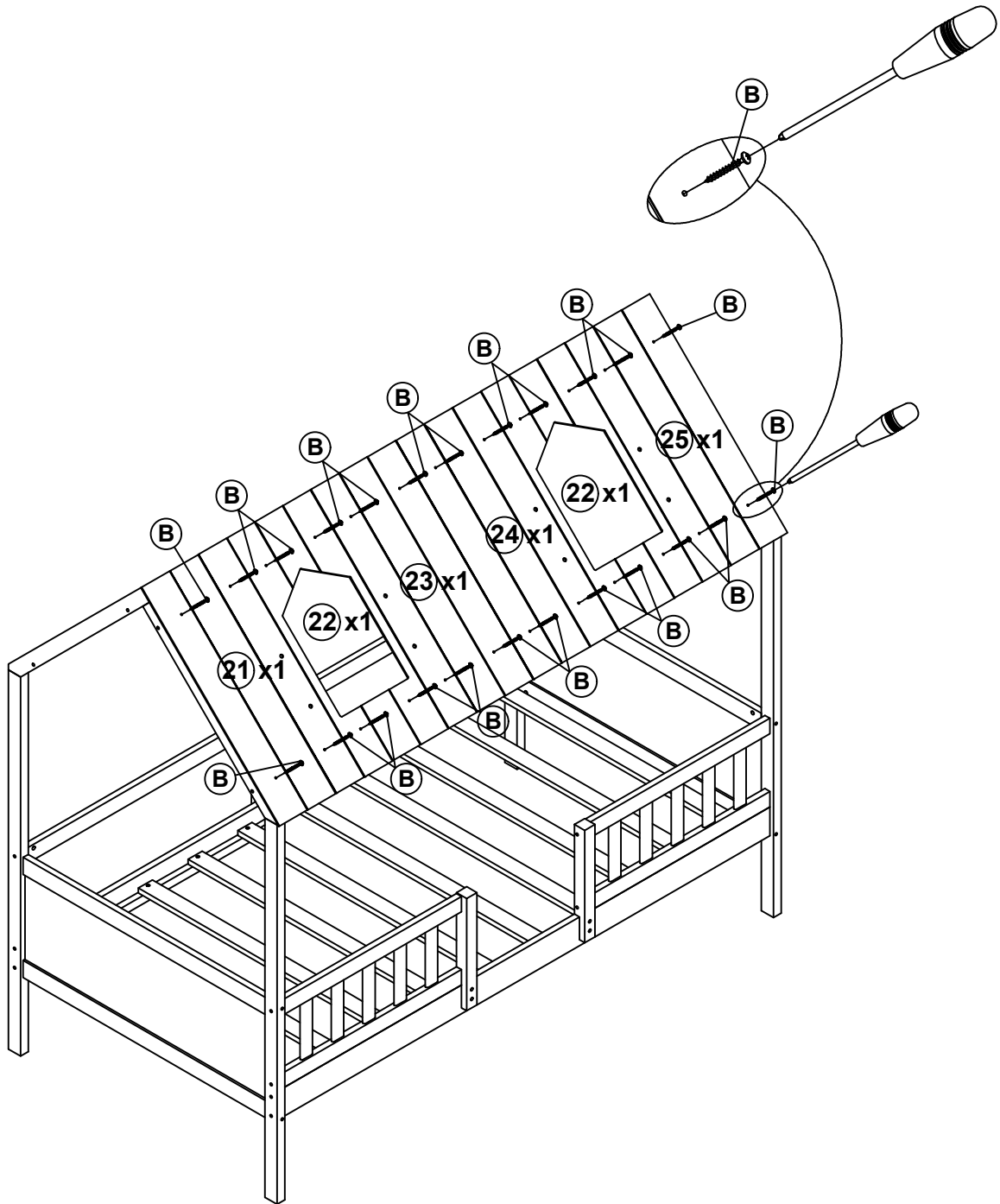

**B**

Ø4x20





24PCS

# ASSEMBLY INSTRUCTIONS

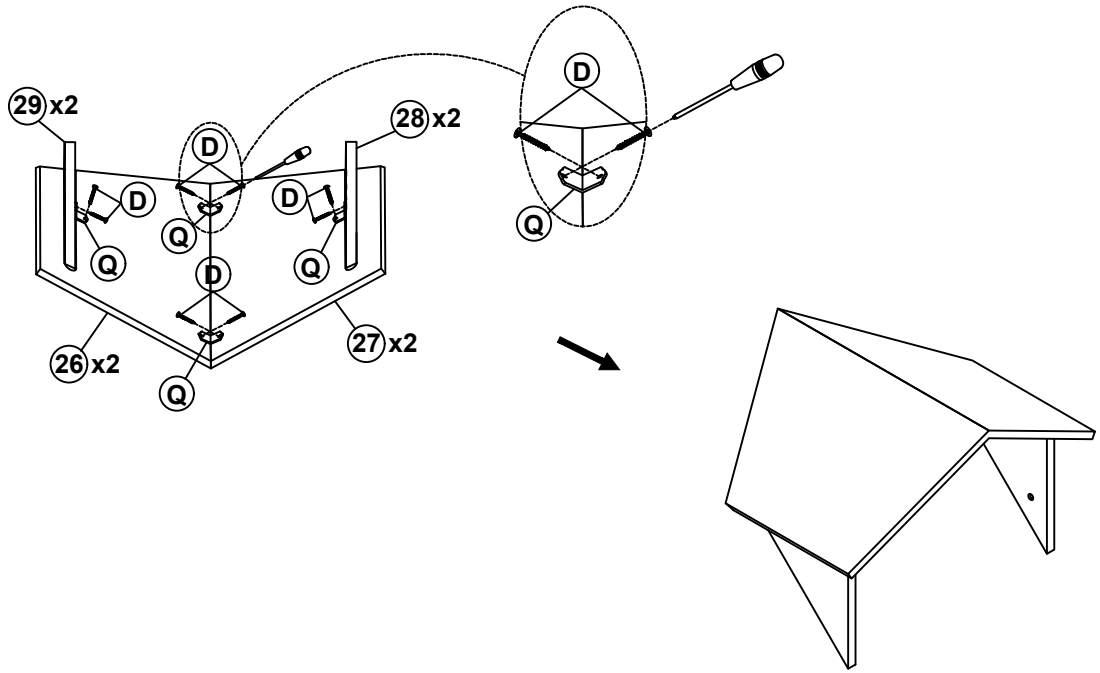
## Step 9



|          |         |   |       |          |         |   |      |
|----------|---------|---|-------|----------|---------|---|------|
| <b>D</b> | Ø3.5x12 |  | 16PCS | <b>Q</b> | 15x15x2 |  | 8PCS |
|----------|---------|---|-------|----------|---------|---|------|

## Step 10

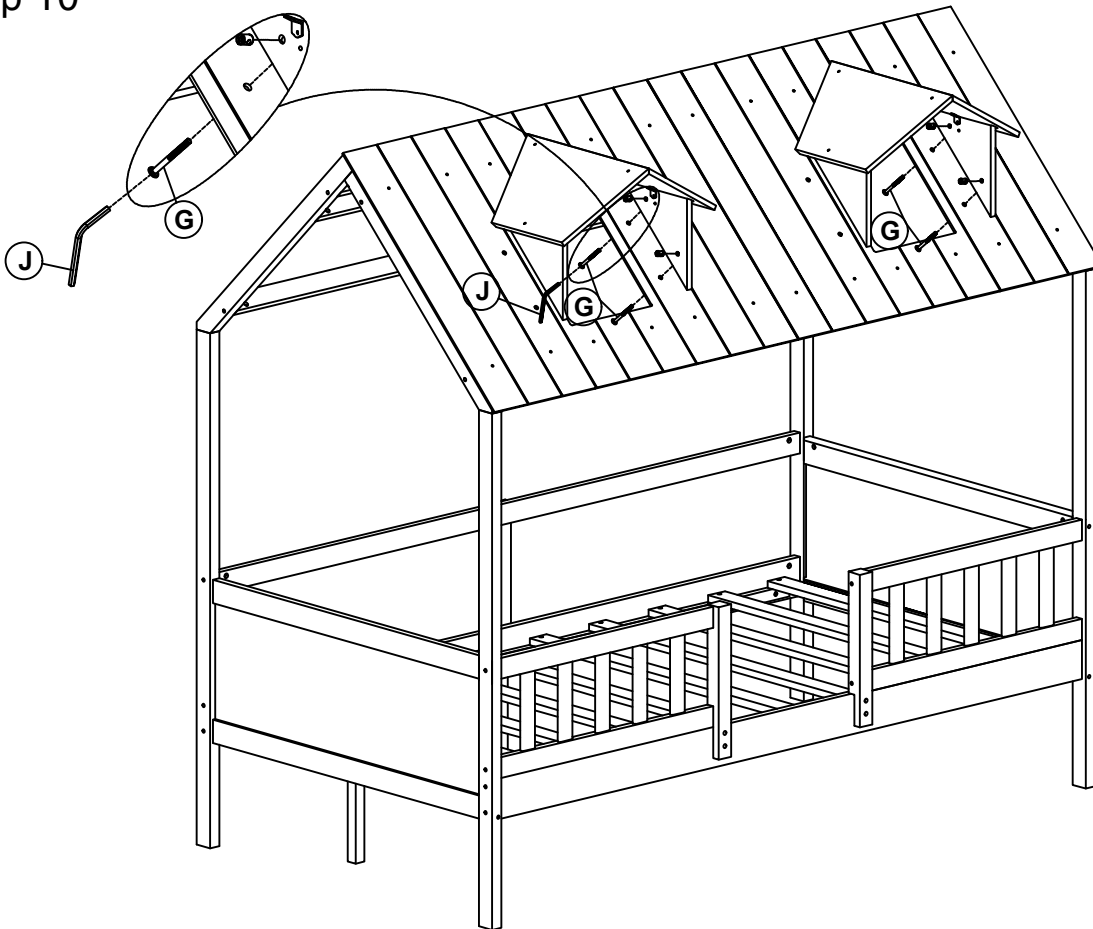



|          |        |   |      |          |      |   |     |
|----------|--------|---|------|----------|------|---|-----|
| <b>G</b> | 1/4x45 |  | 8PCS | <b>J</b> | 4x58 |  | 1PC |
|----------|--------|---|------|----------|------|---|-----|

# ASSEMBLY INSTRUCTIONS

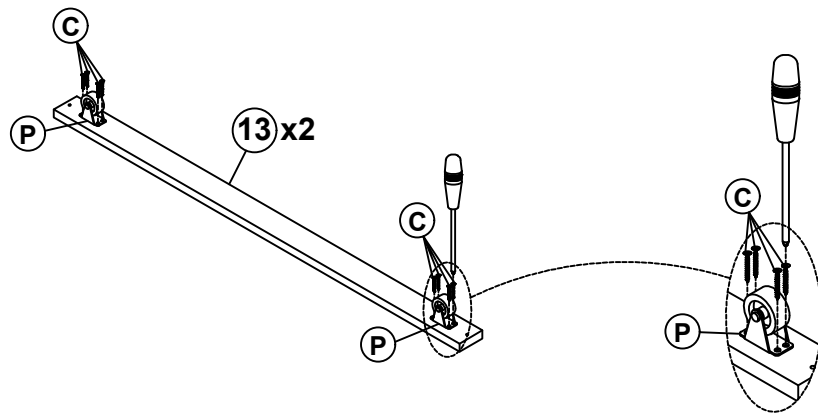
## Step 11



|          |       |   |       |          |           |   |      |
|----------|-------|---|-------|----------|-----------|---|------|
| <b>C</b> | Ø4x15 |  | 16PCS | <b>P</b> | Ø38x46x38 |  | 4PCS |
|----------|-------|---|-------|----------|-----------|---|------|

## Step 12

First attach 2pcs part 13 to the front and end of the frame, between side rails. Then attach the remaining part 13 equidistantly between side rails.

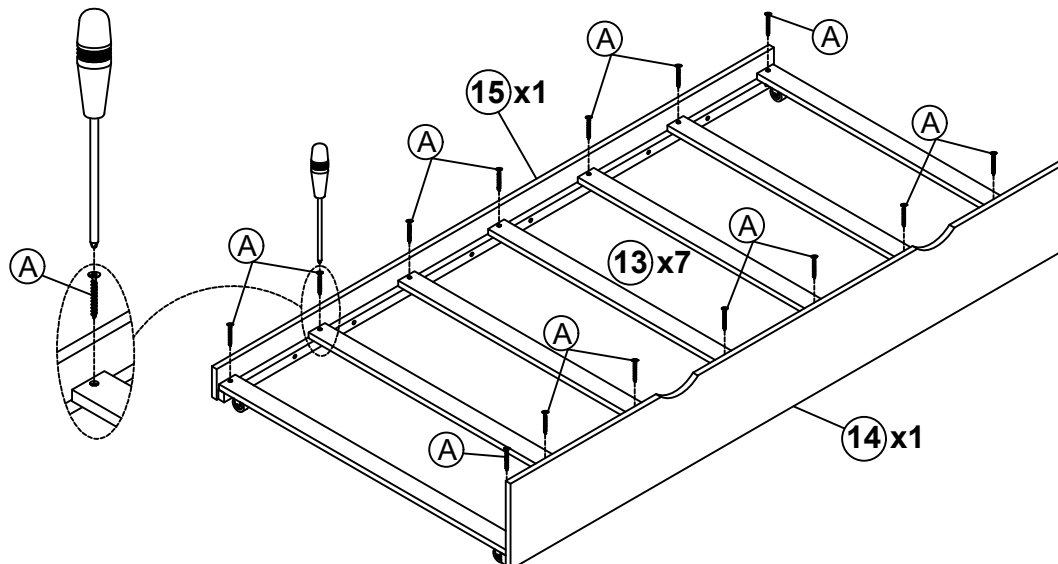



|          |       |   |       |
|----------|-------|---|-------|
| <b>A</b> | Ø4x30 |  | 14PCS |
|----------|-------|---|-------|

# ASSEMBLY INSTRUCTIONS

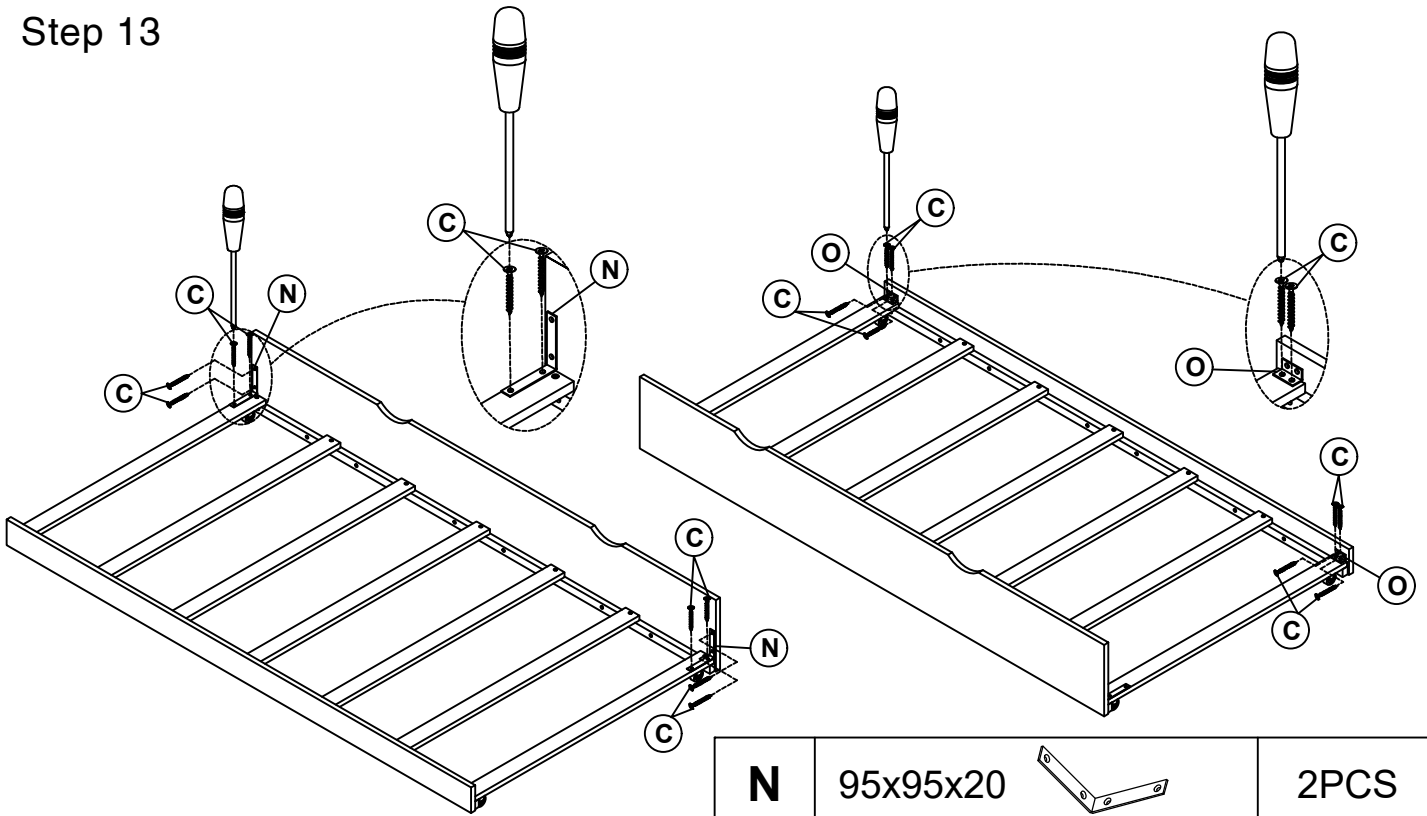
## Step 13

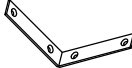

|          |          |   |       |
|----------|----------|---|-------|
| <b>N</b> | 95x95x20 |    | 2PCS  |
| <b>C</b> | Ø4x15    |    | 16PCS |
| <b>O</b> | 40x20x20 |  | 2PCS  |

## Step 14

