

# ASSEMBLY INSTRUCTION

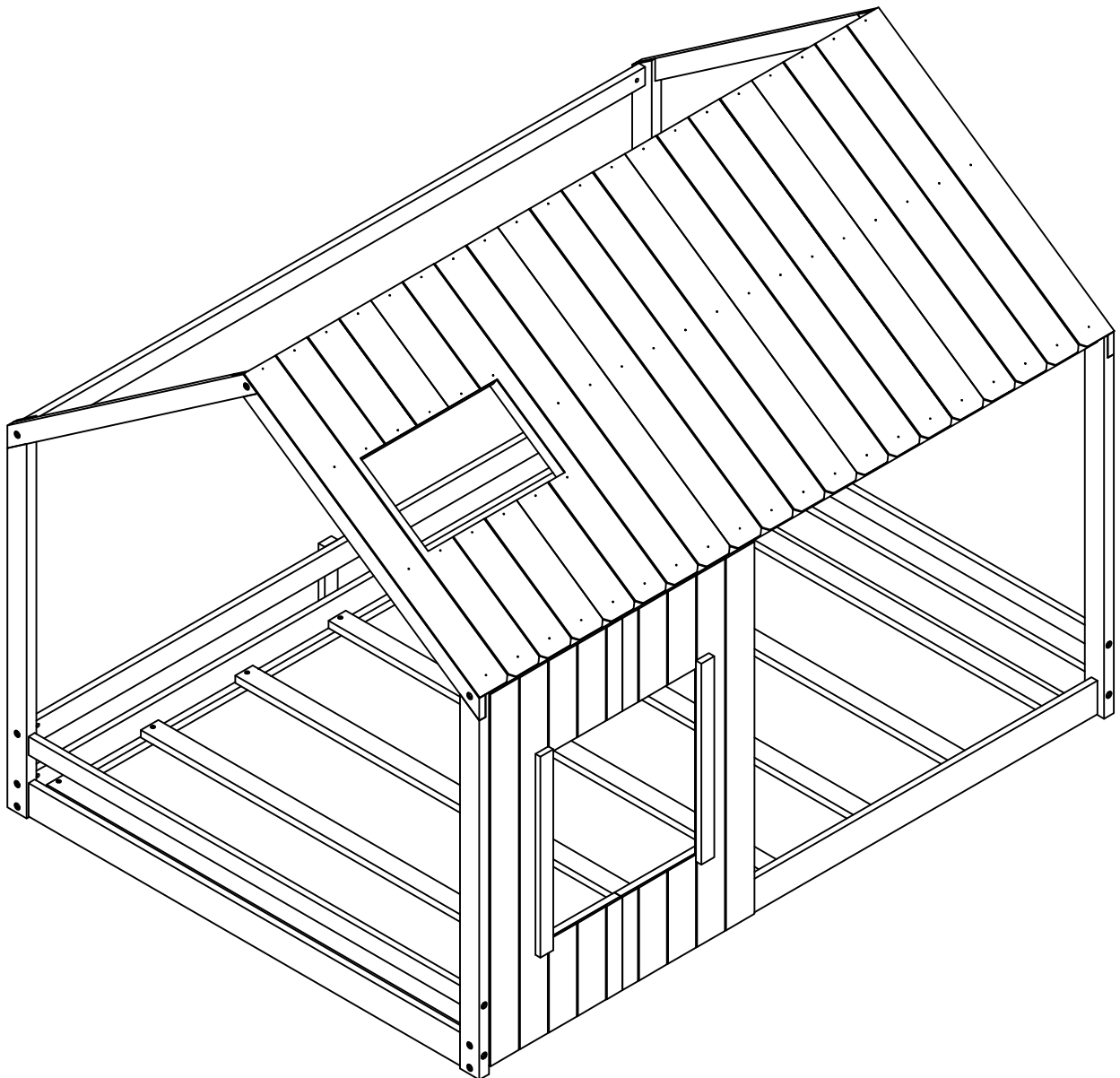

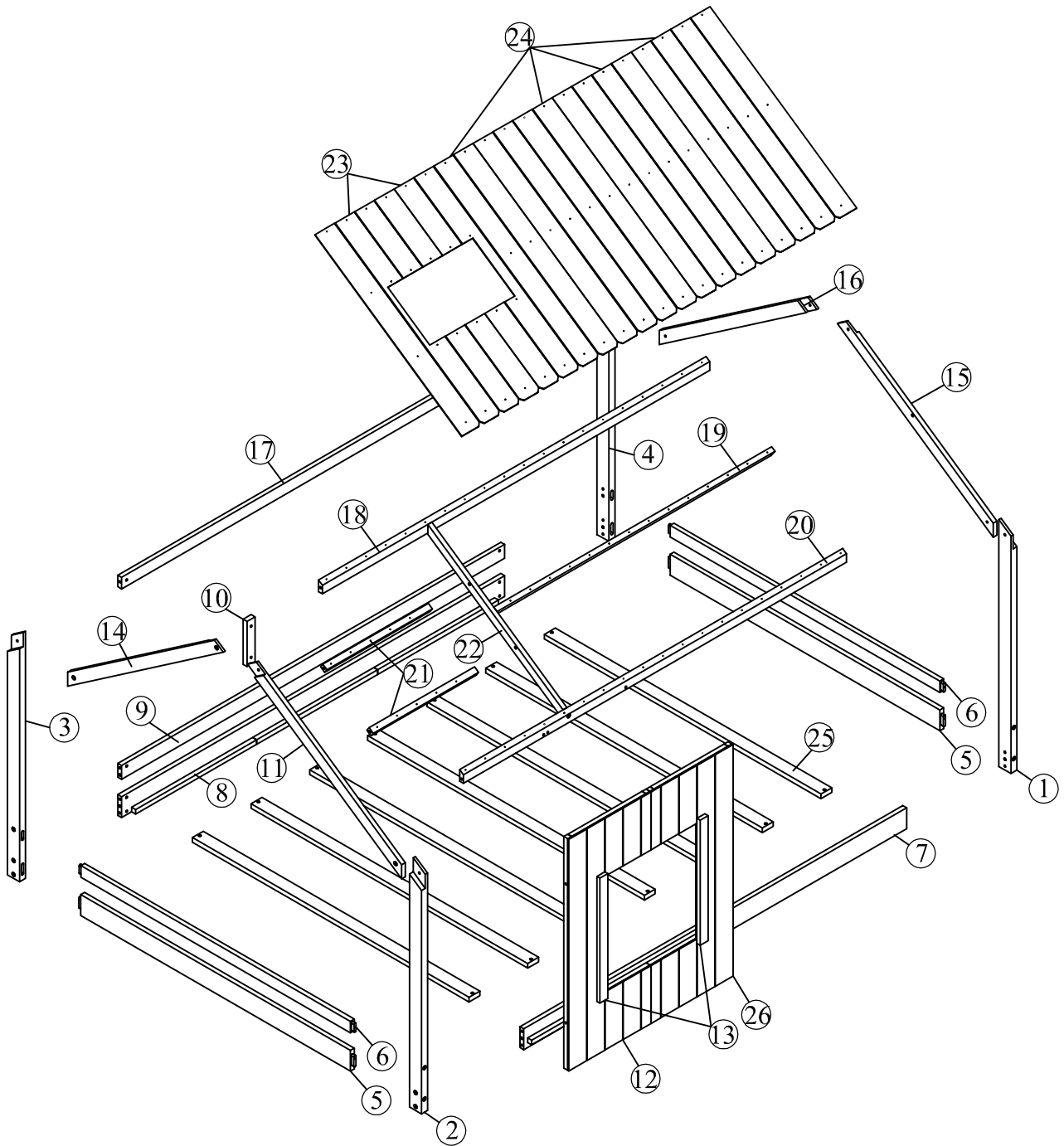



SKU CODE: WF296897



# Detail view:

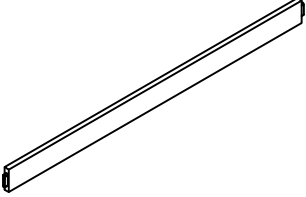
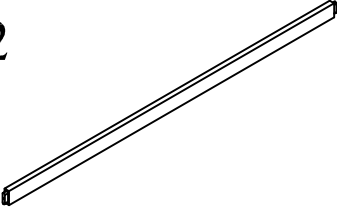
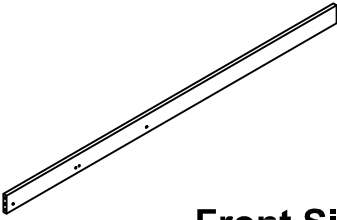
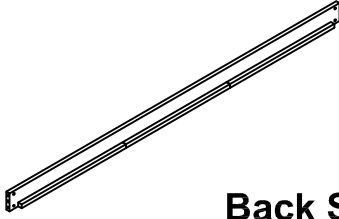
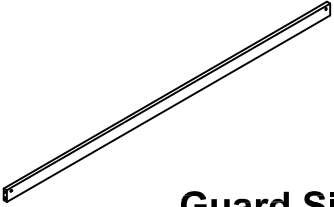

## Part List (WF296897)

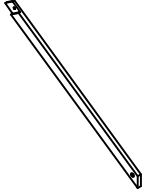
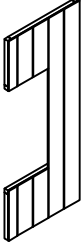
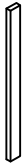
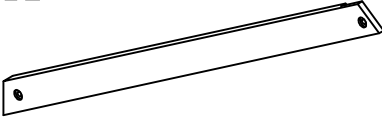
<p>① x1</p>  <p style="text-align: center;"><b>Front Right Leg</b></p>	<p>② x1</p>  <p style="text-align: center;"><b>Front Left Leg</b></p>
<p>③ x1</p>  <p style="text-align: center;"><b>Back Right Leg</b></p>	<p>④ x1</p>  <p style="text-align: center;"><b>Back Left Leg</b></p>
<p>⑤ x2</p>  <p style="text-align: center;"><b>Headboard - Foodboard</b></p>	<p>⑥ x2</p>  <p style="text-align: center;"><b>Headboard - Foodboard Guards</b></p>
<p>⑦ x1</p>  <p style="text-align: center;"><b>Front Side Rail</b></p>	<p>⑧ x1</p>  <p style="text-align: center;"><b>Back Side Rail</b></p>
<p>⑨ x1</p>  <p style="text-align: center;"><b>Guard Side Rail</b></p>	<p>⑩ x1</p>  <p style="text-align: center;"><b>Guard Side Rail</b></p>
<p>⑪ x1</p>  <p style="text-align: center;"><b>Front Left Roof Rail</b></p>	<p>⑫ x1</p>  <p style="text-align: center;"><b>Panel Side Rail</b></p>
<p>⑬ x2</p>  <p style="text-align: center;"><b>Decorative Bar</b></p>	<p>⑭ x1</p>  <p style="text-align: center;"><b>Back Left Roof Rail</b></p>

# Part List (WF296897)

15 x1

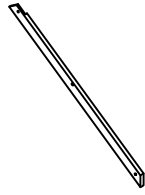

Front Right Roof Rail

16 x1

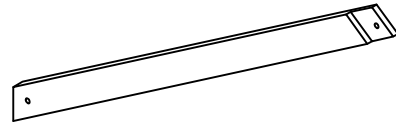

Back Right Roof Rail

17 x1

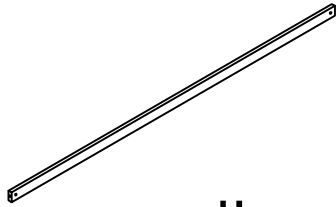

Upper Guard

18 x1

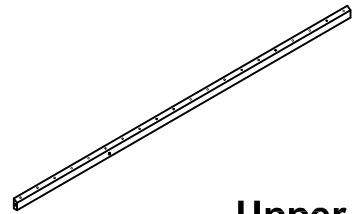

Upper Guard

19 x1

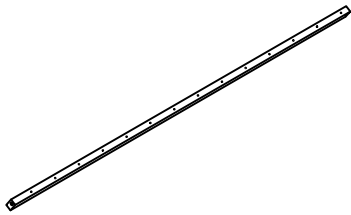

Upper Guard

20 x1

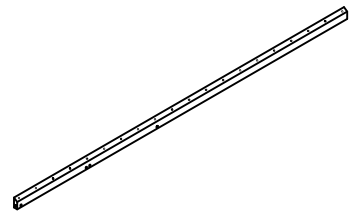

Upper Guard

21 x2

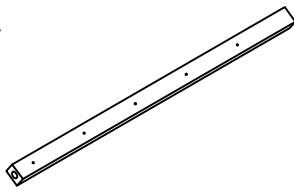

Upper Guards

22 x1

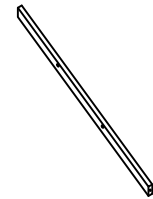

Upper Guard

23 x2

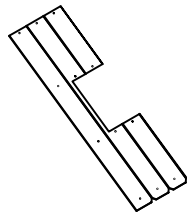

Panel Roof Rail

24 x4

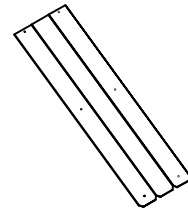

Panel Roof Rail

25 x7

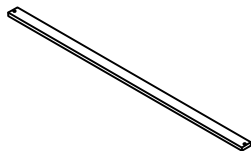





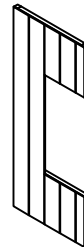



Slats

26 x1



Panel Side Rail



## Hardware List (WF296897)

No.	OUTLOOK	DESC	QTY
(A)		Dowel Ø10*30mm	8
(B)		Dowel Ø10*40mm	12
(C)		Screws Ø6.5*30mm	2
(D)		Screws Ø6.5*70mm	8
(E)		Bolts 1/4"*30mm	12
(F)		Bolts 1/4"*70mm Brass fin insert 1/4"*13mm	16
(G)		Screws #8*25mm	14
(H)		Round head screw #8*20mm	40
(I)		Allen key 60*22*4mm	1

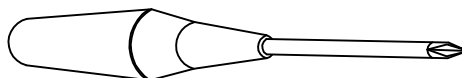
### ASSEMBLY TOOLS REQUIRED (NOT INCLUDED)



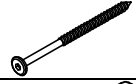

**STEP 1:**

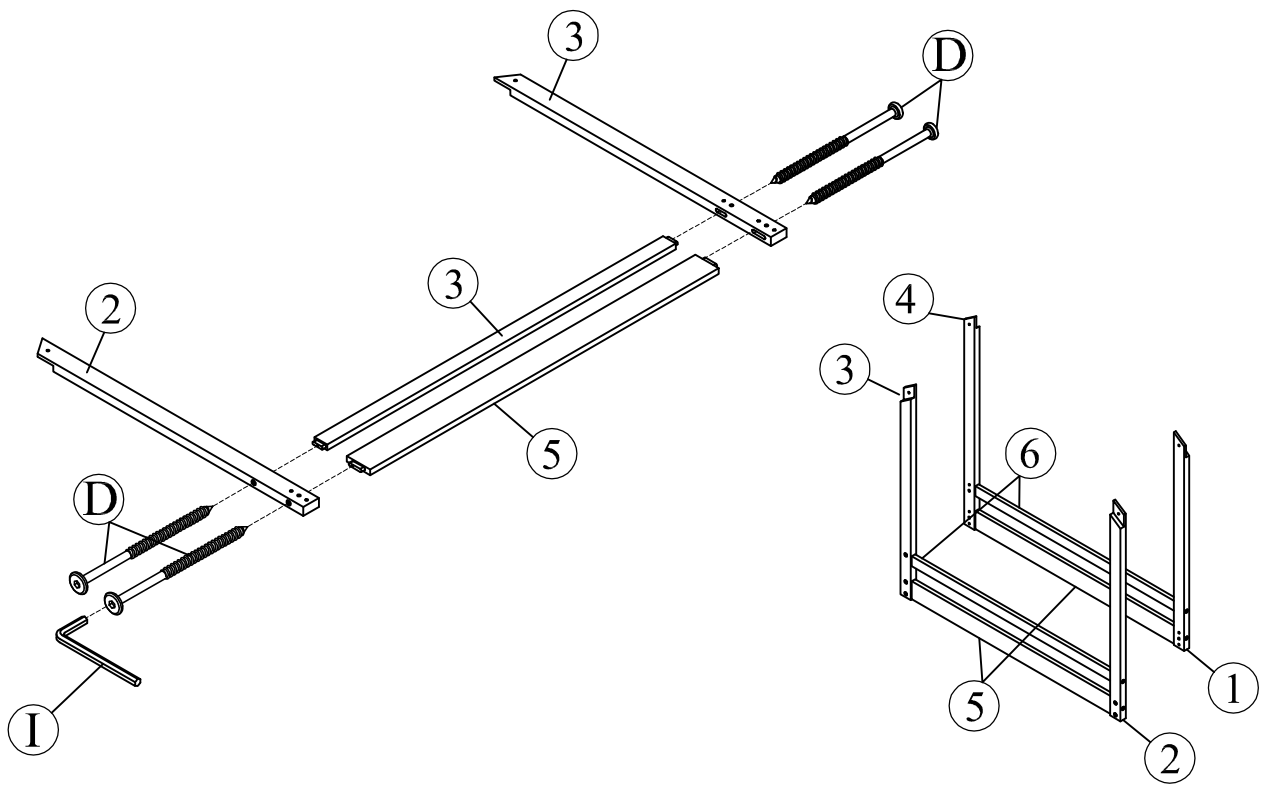
(D)		08
(I)		01



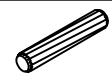

**STEP 2:**

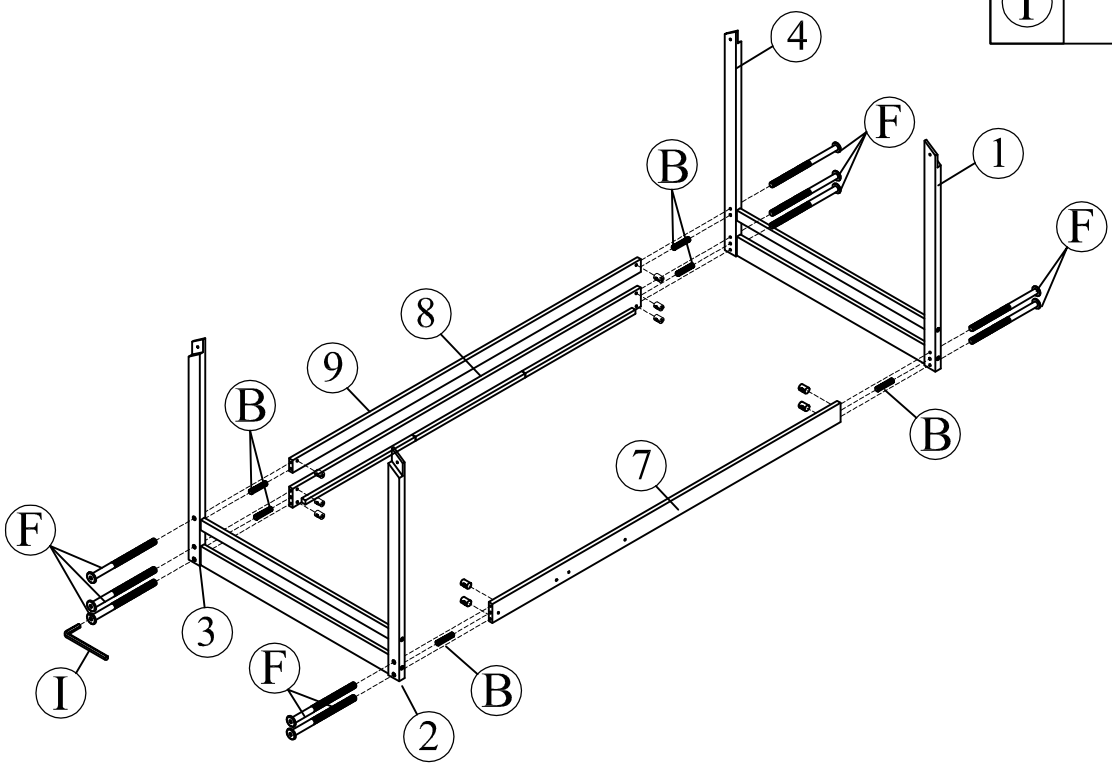
(B)		06
(F)		10
(I)		01





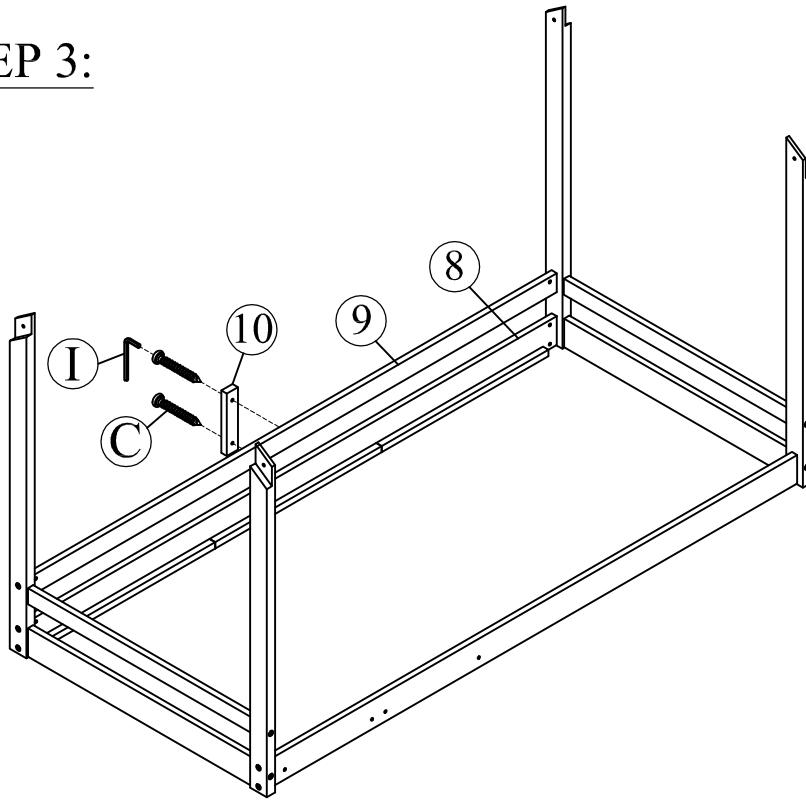

**STEP 3:**

(C)		02
(I)		01

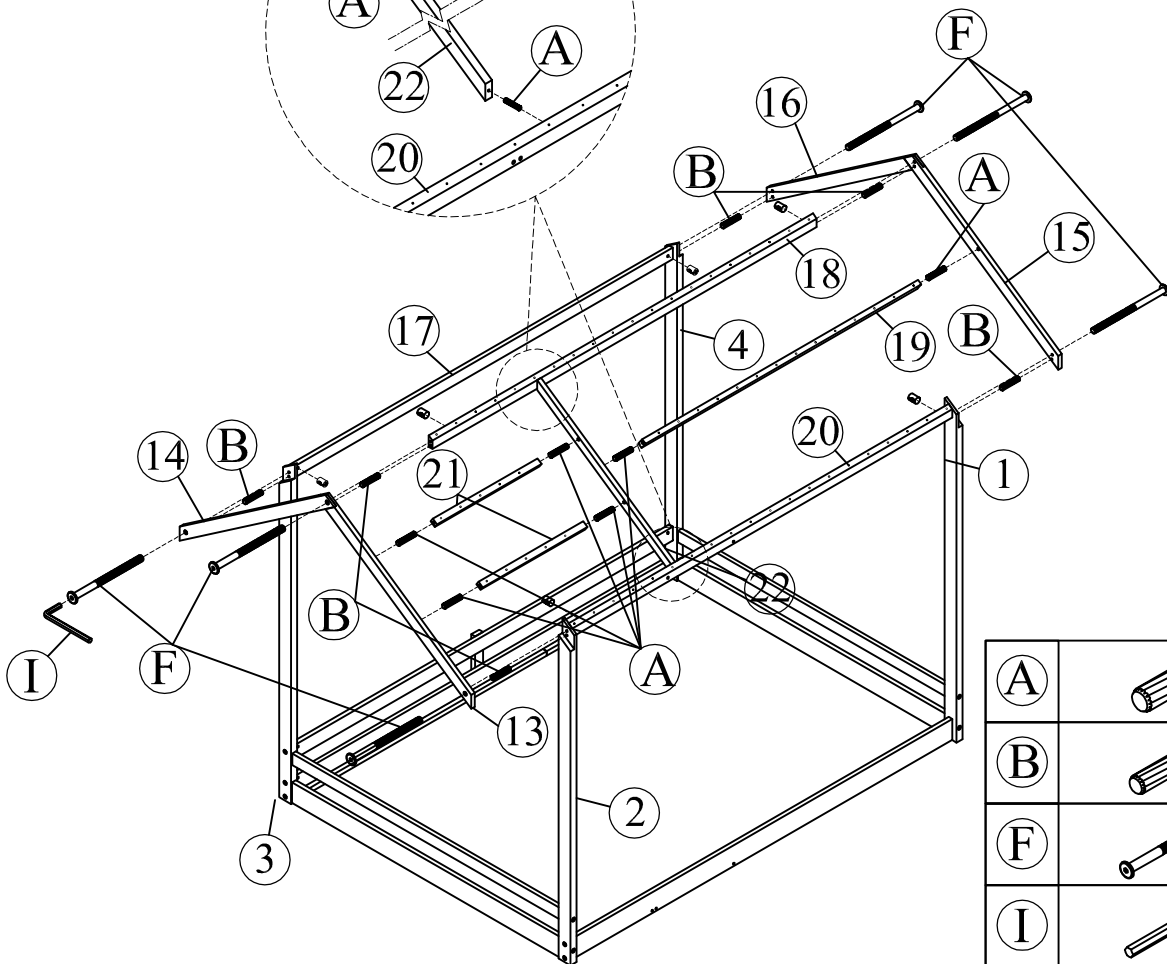
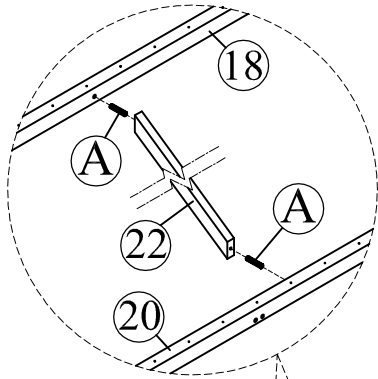

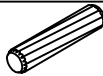
**STEP 4:**



(A)		08
(B)		06
(F)		06
(I)		01

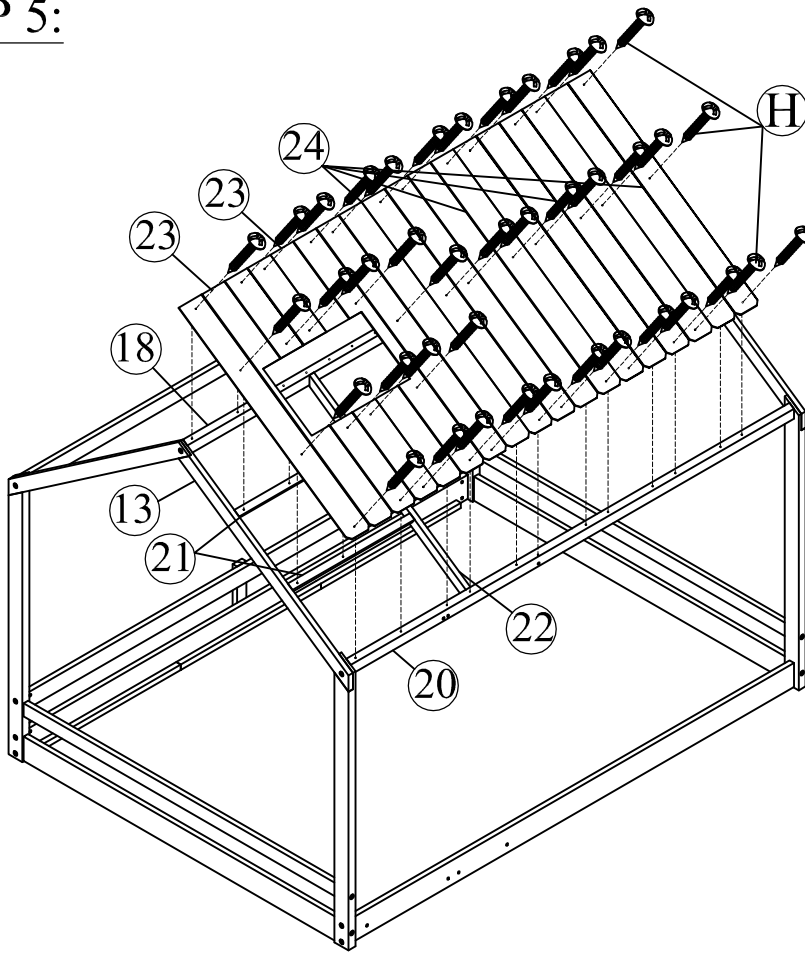

**STEP 5:**

H		40
---	---	----

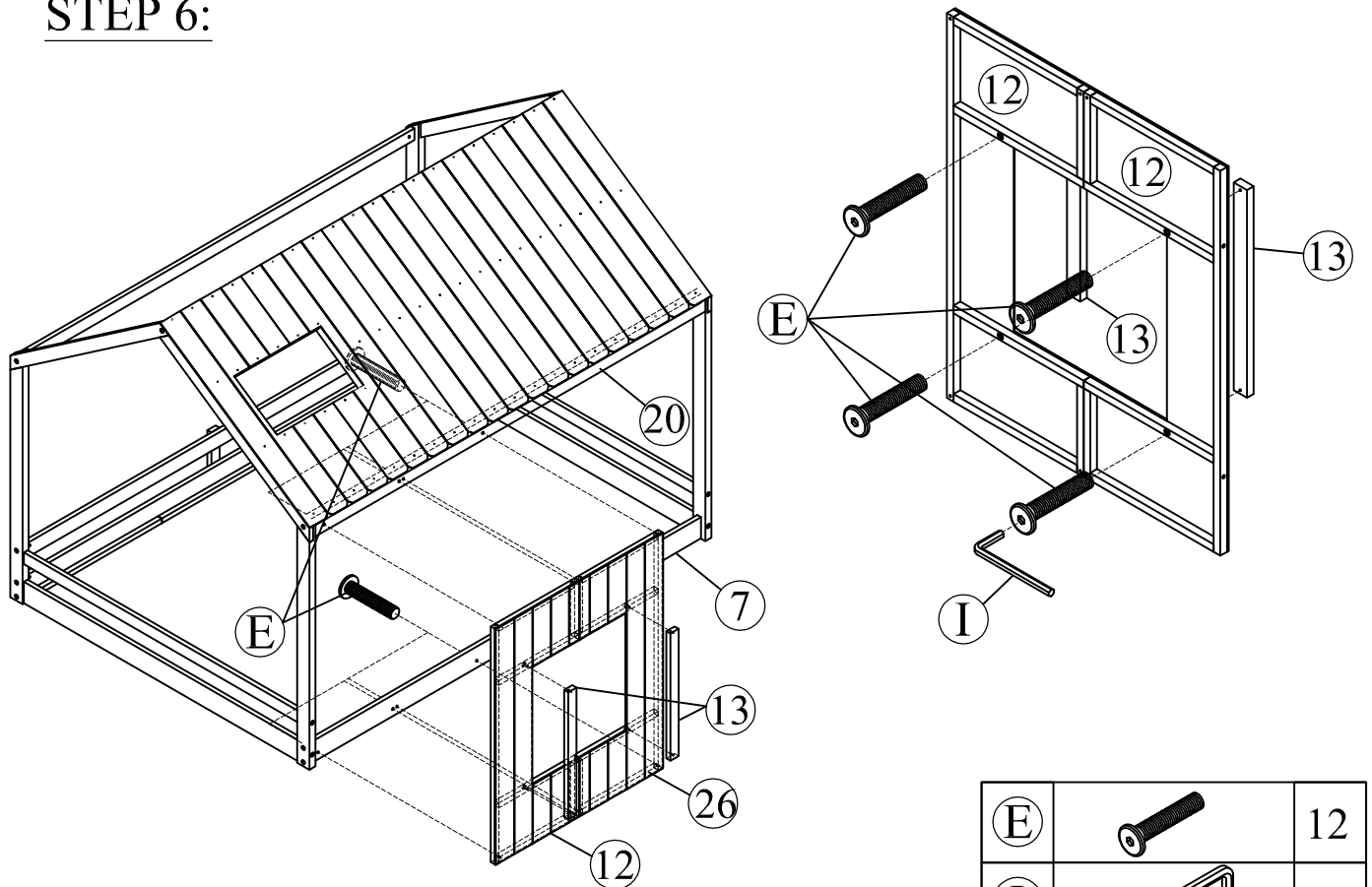

**STEP 6:**



E		12
I		01



STEP 7:

G		14
---	---	----

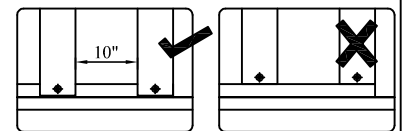
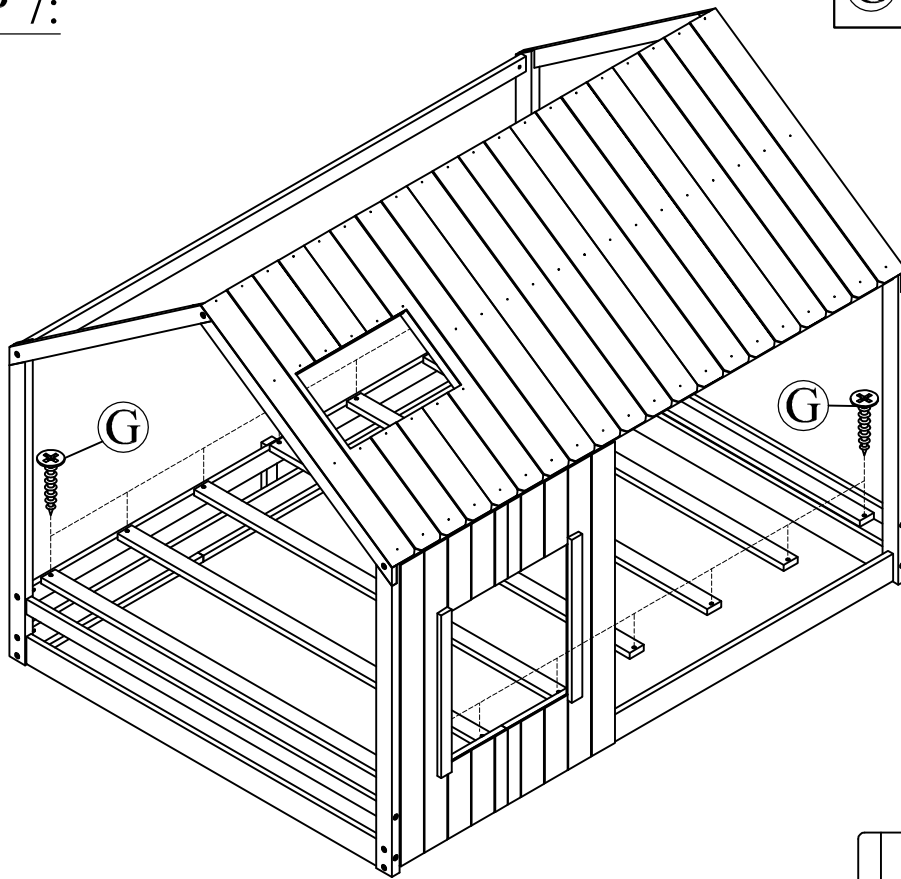

FINAL:

