

ASSEMBLY INSTRUCTIONS

T/T BUNK BED + BOTTOM GUARDRAIL

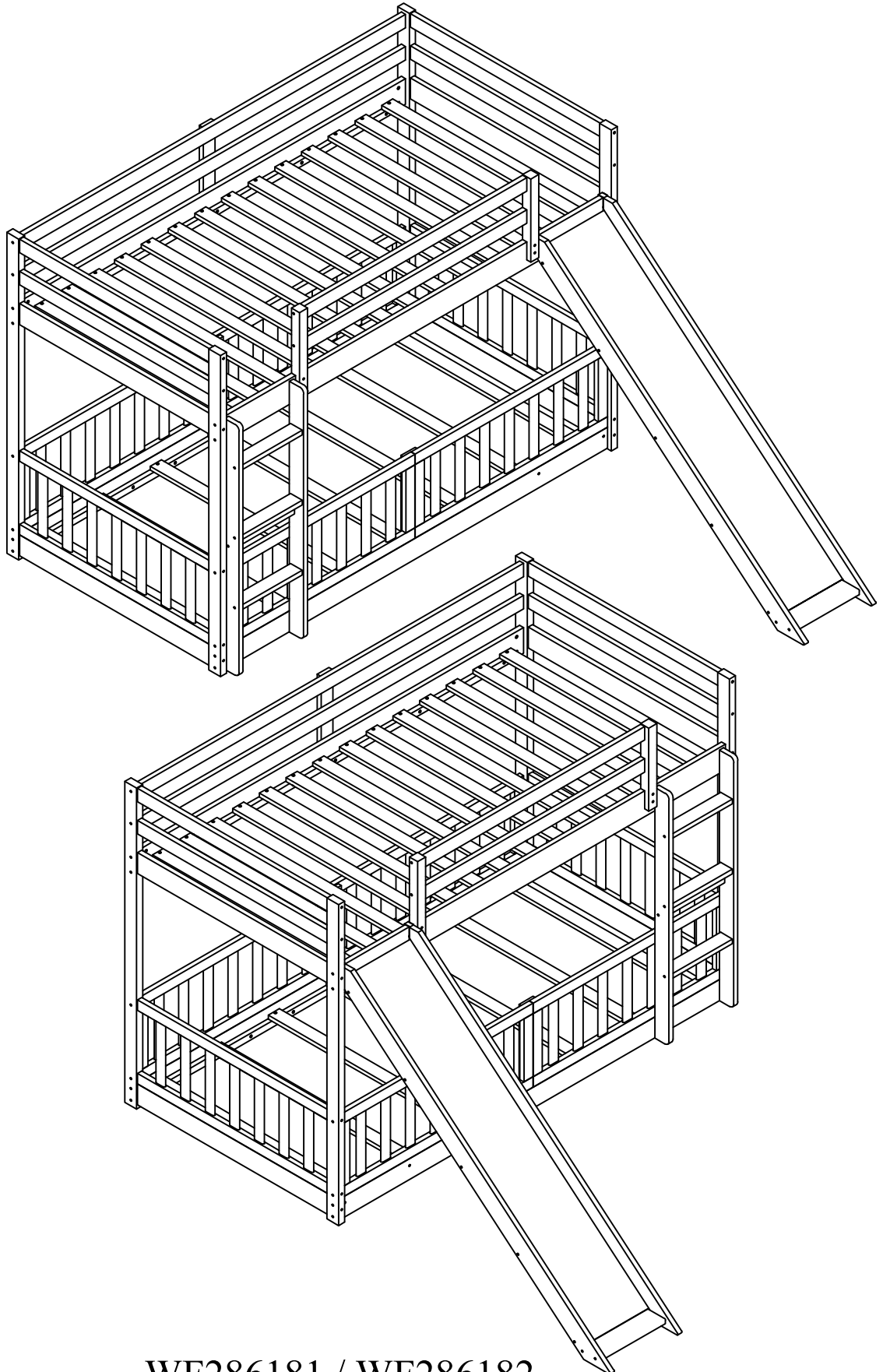

WF286181 / WF286182

ASSEMBLY INSTRUCTIONS



SAFETY WARNINGS



1. This bed is designed for use only mattress(es) meeting the specifications on upper and lower bunks :

Down bed

Bed Type	Length	Width	Thickness
Twin Standard	74"-75"	38 $\frac{1}{2}$ "	8" max

Up bed (bunk bed and tribed included)

Bed Type	Length	Width	Thickness
Twin Standard	74"-75"	38 $\frac{1}{2}$ "	6" max

2. Replacement part, including additional guardrails, may be obtained from any of our (GIGACLOUD TECHNOLOGY (USA) INC.) dealer
3. Follow the information on the warnings appearing on the upper bunk bed end structure and on the carton. Do not remove warning label from the bed.
4. Always use the recommended size mattresses or mattress supports , or both, to help prevent the likelihood of entrapment or falls.
5. Surface of the mattress must be at least 5" (127mm) below the upper edge of guardrails.
6. Do not allow children under 6 years of age to use the upper bunk .
7. Periodically check ensure that the guardrail, ladder, and other components are in their proper position , free from damage, and that all connectors are tight.
8. Do not allow horseplay on or under the bed and prohibit jumping on the bed.
9. Always use the ladder for entering and leaving the upper bunk.
10. Do not use substitute parts. Contact the manufacturer or dealer for replacement parts.
11. Use of a night light may provided added safety precaution for a child using the upper bunk.
12. Always use guardrails on both long sides of the upper bunk. If the bunk bed will be placed next to the wall, the guardrail that runs the full length of the bed should be placed against the wall the prevent entrapment between the bed and wall.
13. The use of water or sleep flotation mattresses is prohibited.
14. **STRANGULATION HAZARD** - Never attach or hang items to any part of the bunk bed that are not designed for use with the bed; for example, but not limited to, hook, belts and jump ropes.
15. Keep these instructions for future reference.

ASSEMBLY INSTRUCTIONS

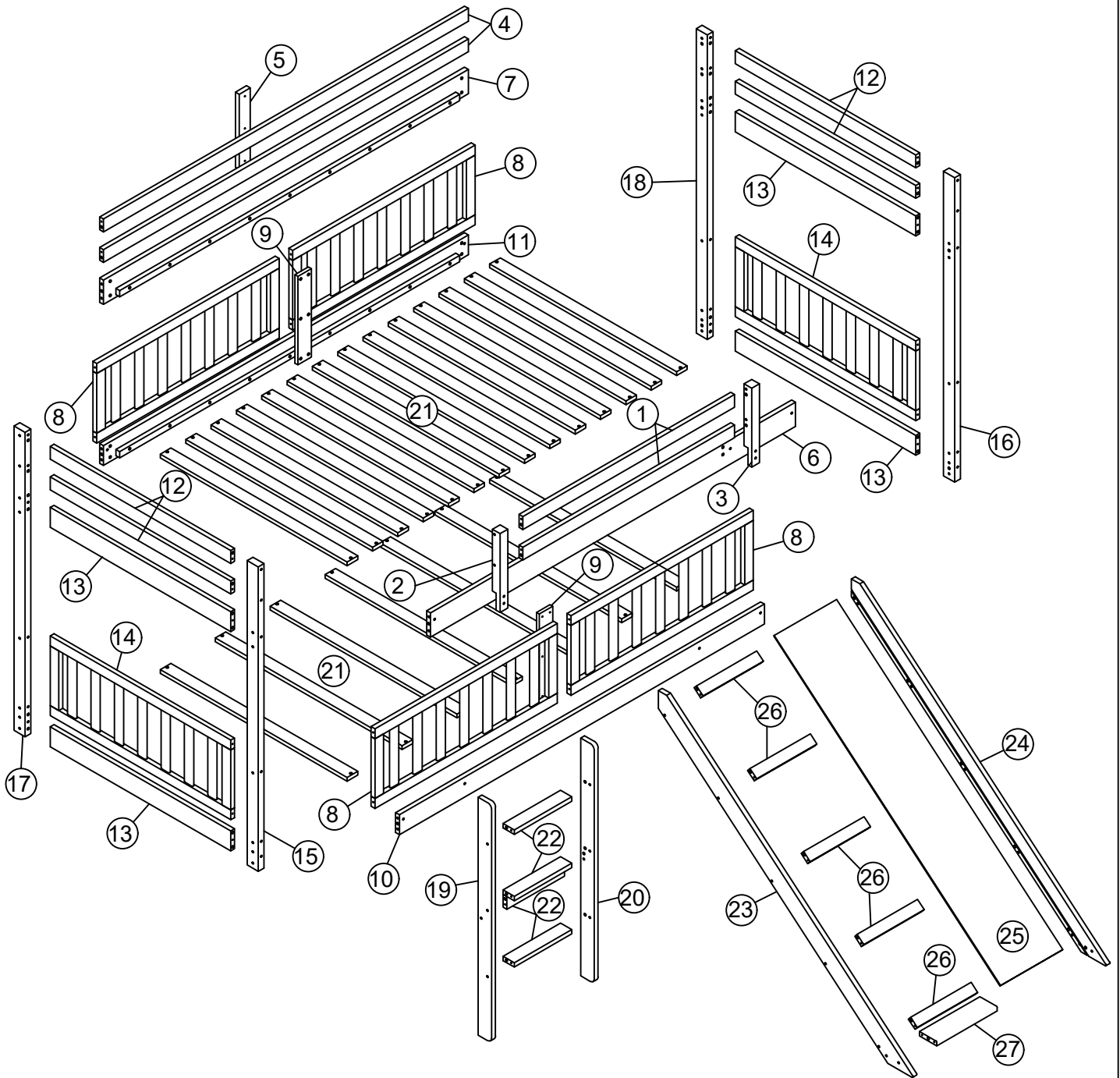





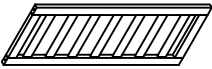
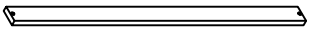
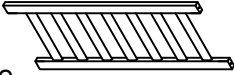

ASSEMBLY INSTRUCTIONS

PARTS LIST

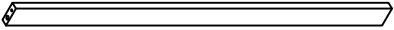
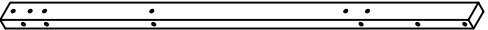
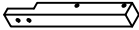
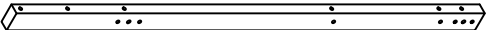
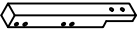
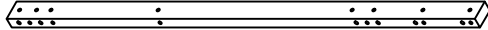
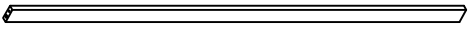
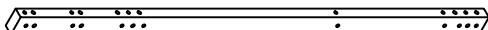
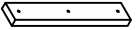
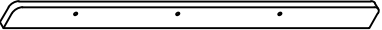
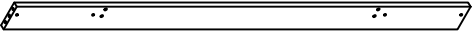
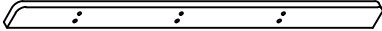
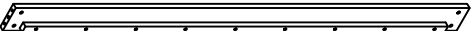
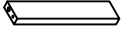
WF286181

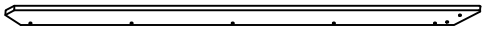
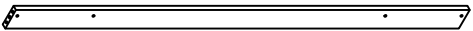
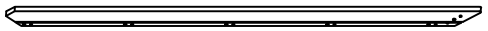

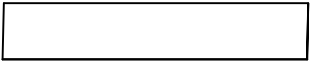
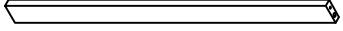
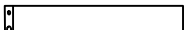
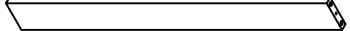







8	 Front & back guard rails frame	4pcs	21	 Slats (Upper 14pcs / Lower 7pcs)	21pcs
14	 Head board frame	2pcs			

WF286182 (Hardware in this SKU)

1	 Front guard rails	2pcs	15	 Left front leg	1pc
2	 Left guard rails support	1pc	16	 Right front leg	1pc
3	 Right guard rails support	1pc	17	 Left back leg	1pc
4	 Back guard rails	2pcs	18	 Right back leg	1pc
5	 Back guard rails support	1pc	19	 Ladder left leg	1pc
6	 Upper front side rail	1pc	20	 Ladder right leg	1pc
7	 Upper back side rail	1pc	22	 Ladder step	4pcs
9	 Front & back guard rails support	2pcs	23	 Slide left leg	1pc
10	 Lower front side rail	1pc	24	 Slide right leg	1pc
11	 Lower back side rail	1pc	25	 Slide panel	1pc
12	 Head board panels	4pcs	26	 Slide support	5pcs
13	 Head board panels	4pcs	27	 Slide bottom panel	1pc

ASSEMBLY INSTRUCTIONS



HARDWARE LIST (WF286182)

A	Ø4x30		57PCS	F	1/4x75		16PCS
B	Ø4x15		6PCS	G	1/4x35		4PCS
C	6.5x100		24PCS	H	Ø10x40		60PCS
D	6.5x80		16PCS	I	70x18x2		2PCS
E	6.5x60		26PCS	J	4x58		1PC

ASSEMBLY INSTRUCTIONS

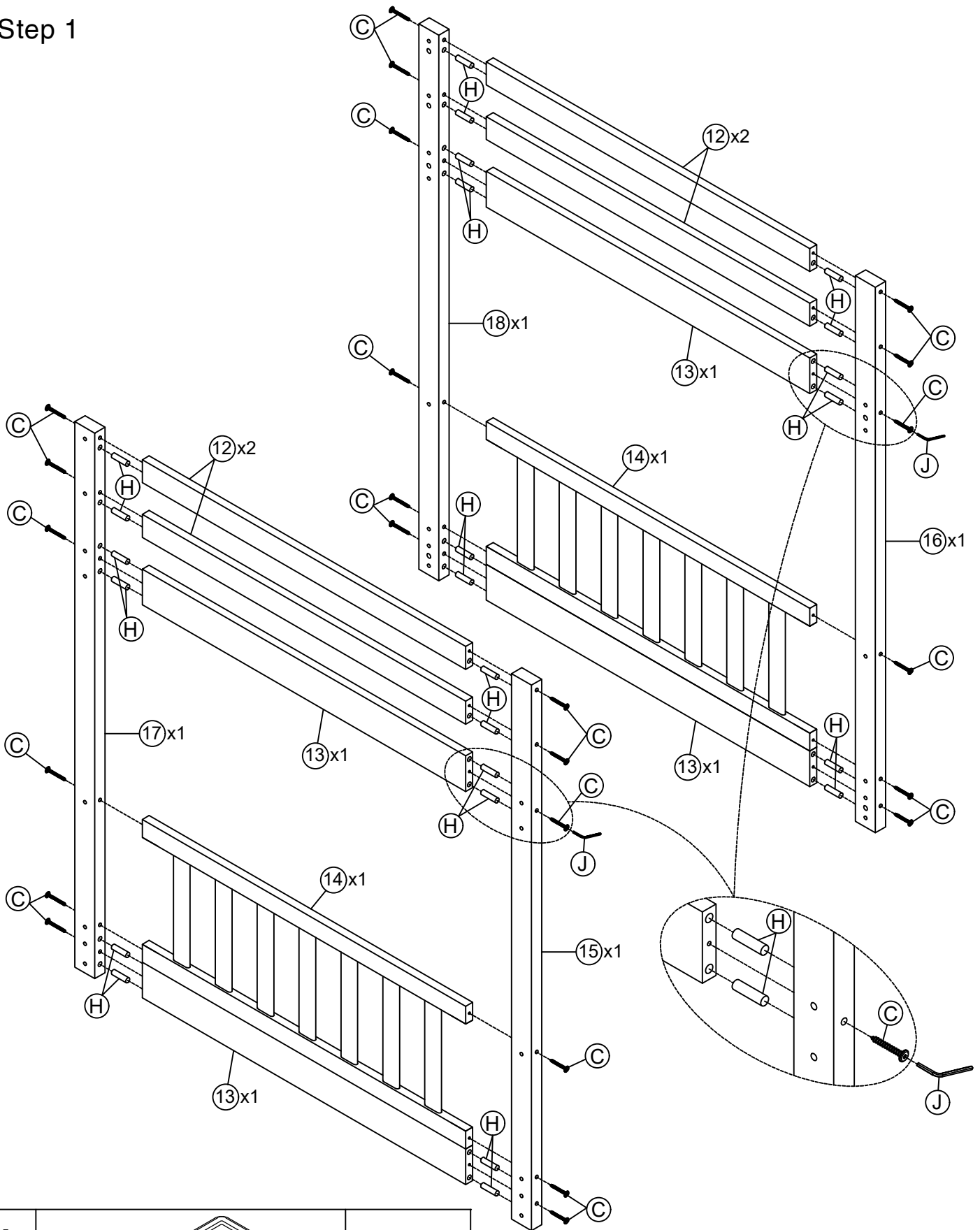
Step 1





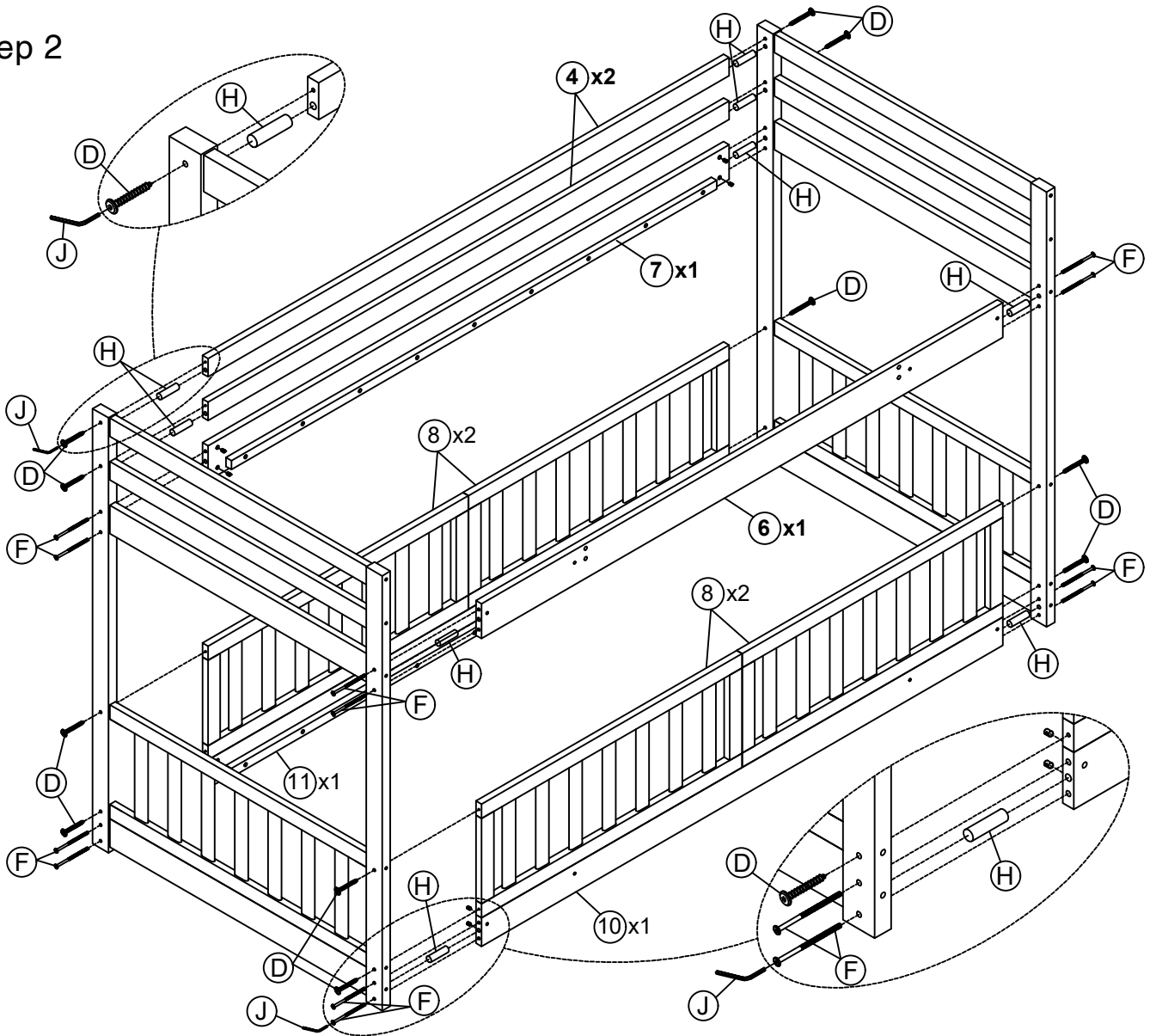

J	4x58		1PC			
C	6.5x100		24PCS	H	Ø10x40 	24PCS

ASSEMBLY INSTRUCTIONS



Step 2

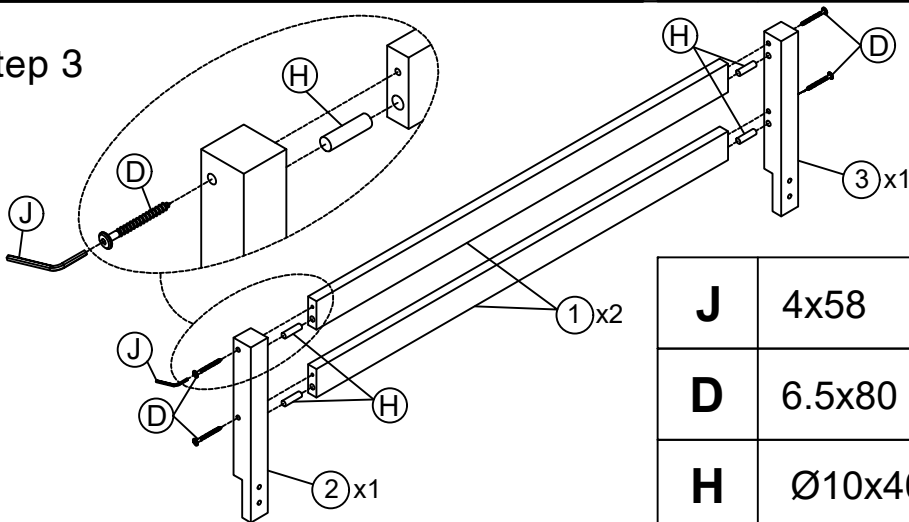

J	4x58		1PC	D	6.5x80		12PCS
H	Ø10x40		12PCS	F	1/4x75		16PCS

Step 3



J	4x58		1PC
D	6.5x80		4PCS
H	Ø10x40		4PCS

ASSEMBLY INSTRUCTIONS

Step 4

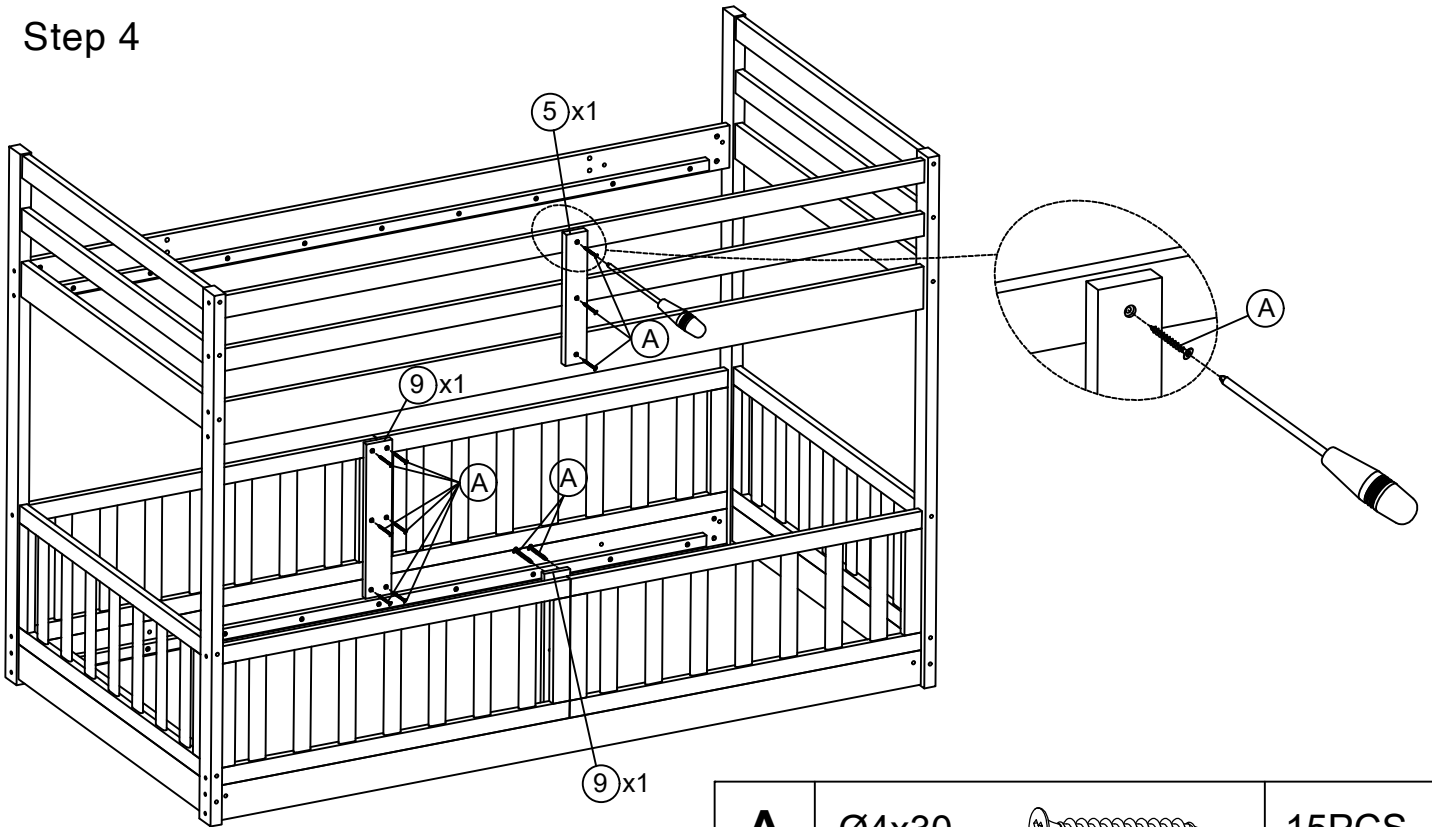

A

Ø4x30



15PCS

Step 5

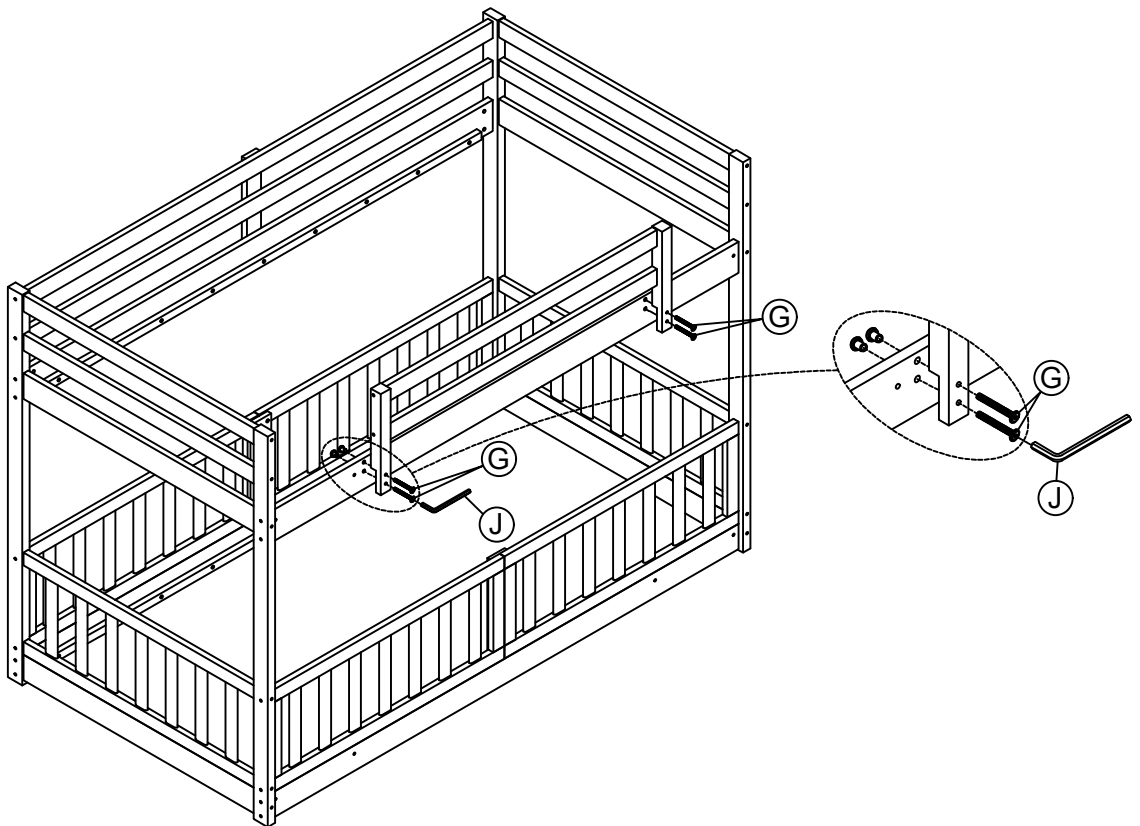

J

4x58



1PC

G

1/4x35



4PCS

ASSEMBLY INSTRUCTIONS

Step 6

First attach 2pcs part 21 to the front and end of the frame between headboard.
Then attach the remaining part 21 equidistantly between headboard

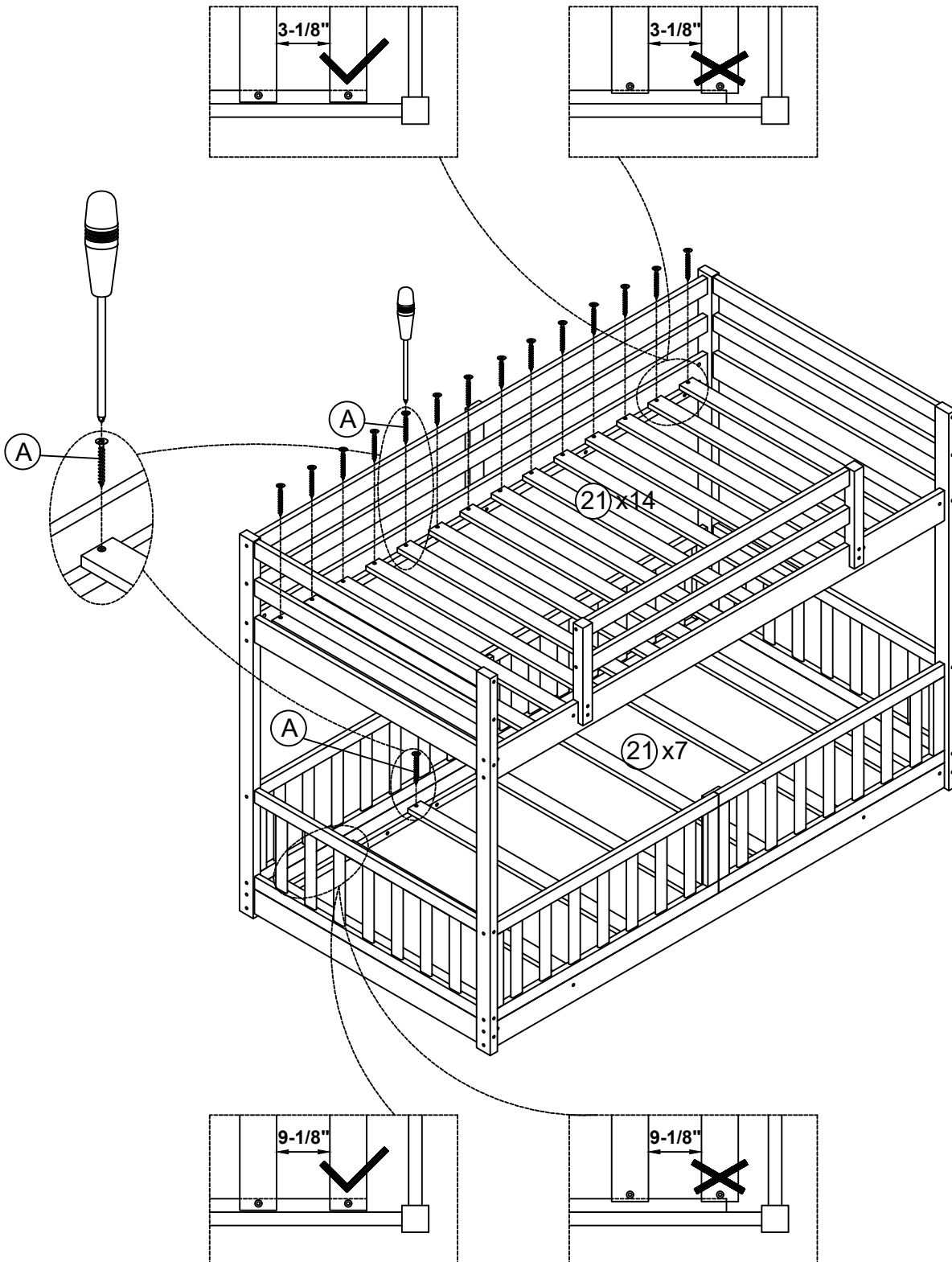

Note : Do not lock the screws of the bed slats to the outermost edge of the bed slats, you need to leave a certain space at the edges, otherwise it will cause the board to break

A

Ø4x30





42PCS

ASSEMBLY INSTRUCTIONS

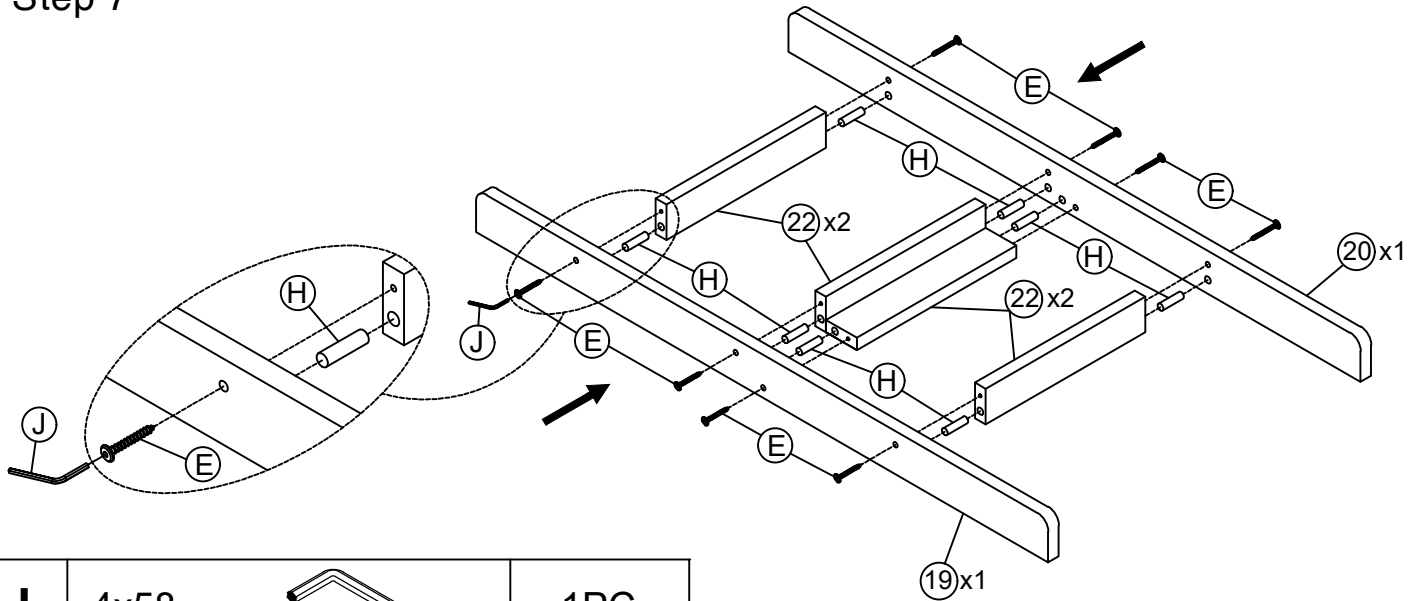



Step 7

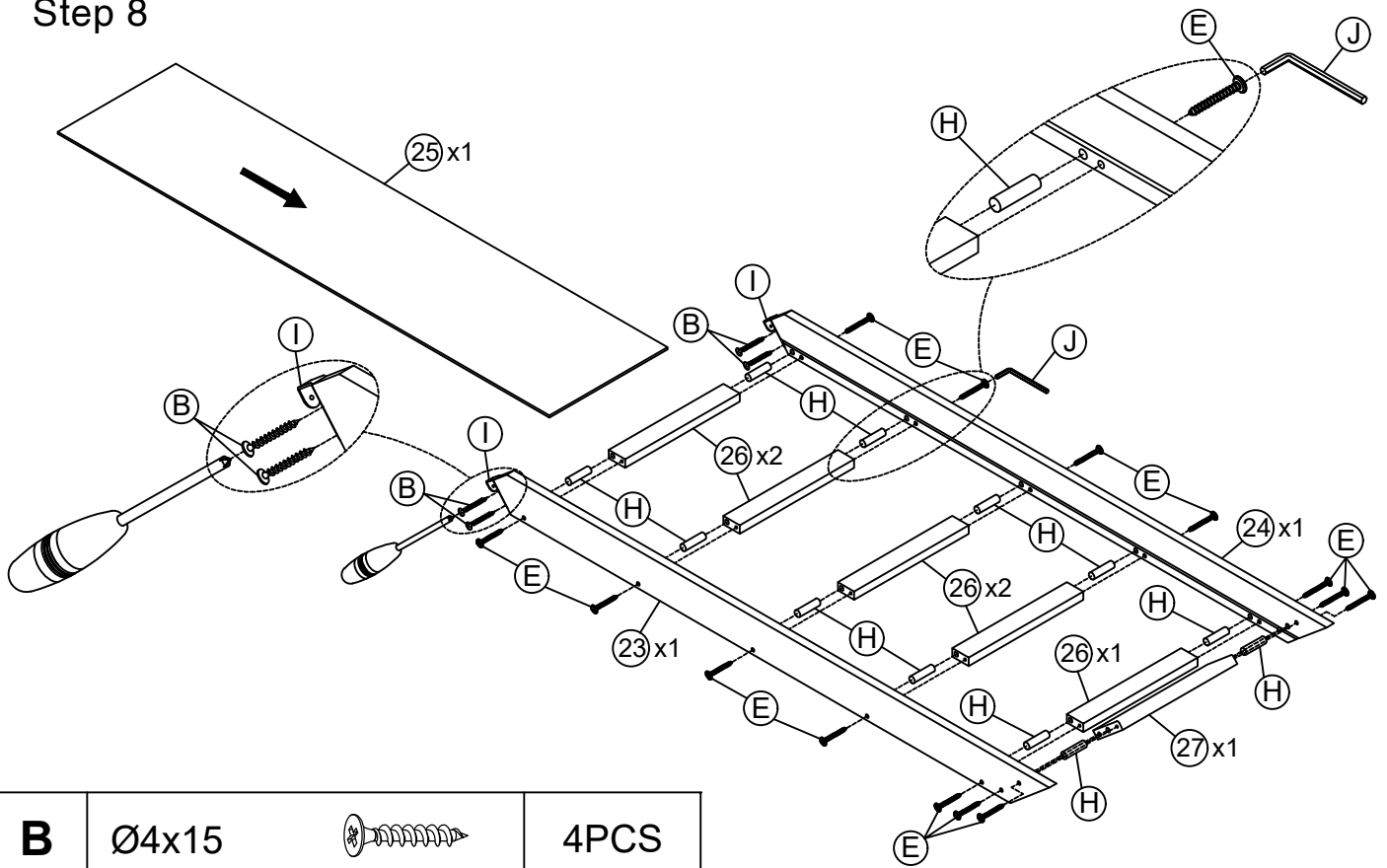

J	4x58		1PC			
E	6.5x60		8PCS	H	Ø10x40	 8PCS

Step 8

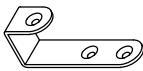



B	Ø4x15		4PCS	J	4x58		1PC
I	70x26x18		2PCS	E	6.5x60		14PCS
H	Ø10x40		12PCS				

ASSEMBLY INSTRUCTIONS

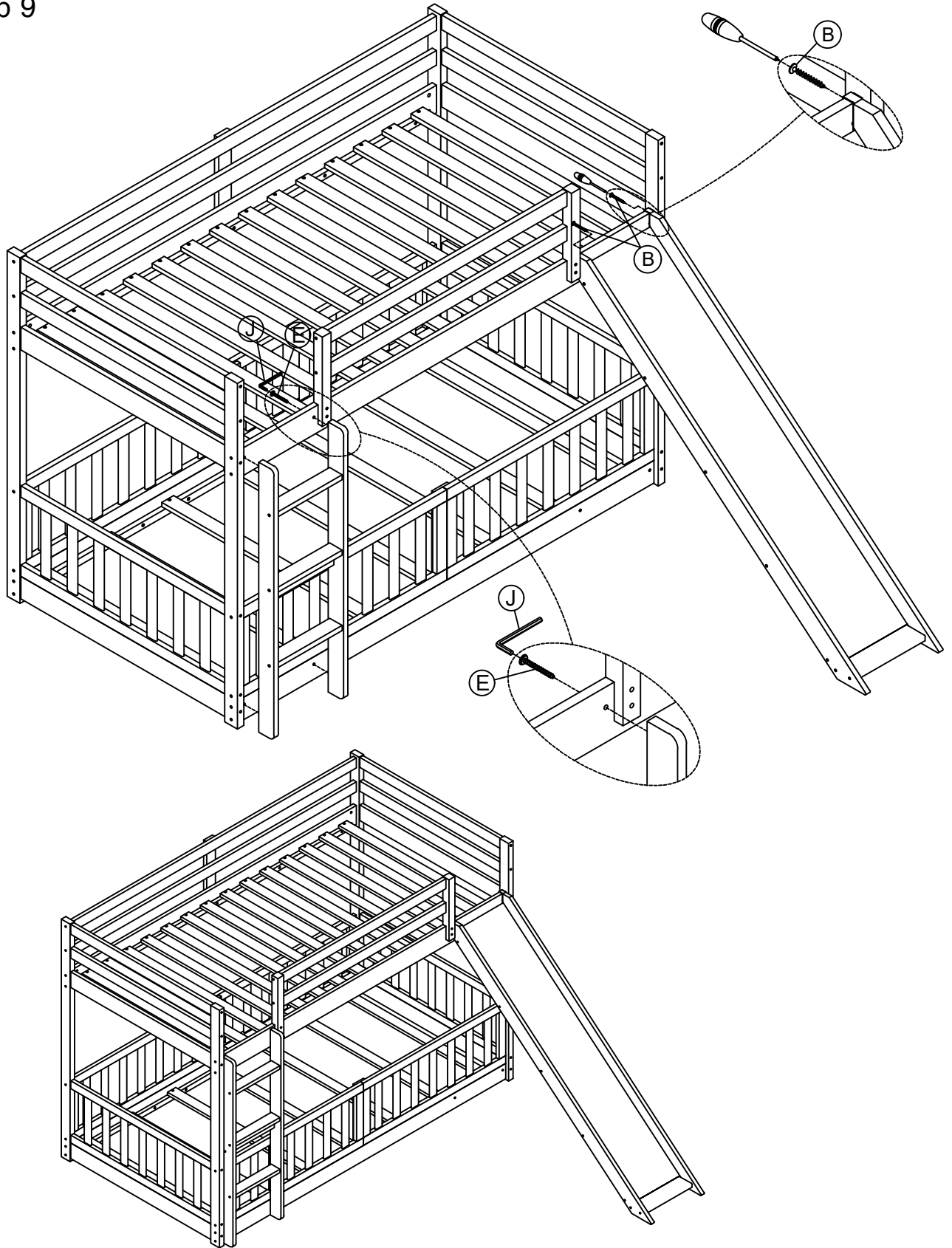
Step 9



B	Ø4x15		2PCS	J	4x58		1PC
				E	6.5x60		4PCS