

# ASSEMBLY INSTRUCTIONS

## FULL LOFT BED WITH SLIDE BRIDGE



WF286242

# ASSEMBLY INSTRUCTIONS



## **SAFETY WARNINGS**



1. This bed is designed for use only mattress(es) meeting the specifications on the upper bunk :

**Upper bunk (bunk bed and trised included)**

<b>Bed Type</b>	<b>Length</b>	<b>Width</b>	<b>Thickness</b>
Full Standard	74"-75"	53" - 54"	6" max

2. Replacement part, including additional guardrails, may be obtained from any of our (GIGACLOUD TECHNOLOGY (USA) INC.) dealer
3. Follow the information on the warnings appearing on the upper bunk bed end structure and on the carton. Do not remove warning label from the bed.
4. Always use the recommended size mattresses or mattress supports , or both, to help prevent the likelihood of entrapment or falls.
5. Surface of the mattress must be at least 5" (127mm) below the upper edge of guardrails.
6. Do not allow children under 6 years of age to use the upper bunk .
7. Periodically check ensure that the guardrail, ladder, and other components are in their proper position , free from damage, and that all connectors are tight.
8. Do not allow horseplay on or under the bed and prohibit jumping on the bed.
9. Always use the ladder for entering and leaving the upper bunk.
10. Do not use substitute parts. Contact the manufacturer or dealer for replacement parts.
11. Use of a night light may provided added safety precaution for a child using the upper bunk.
12. Always use guardrails on both long sides of the upper bunk. If the bunk bed will be placed next to the wall, the guardrail that runs the full length of the bed should be placed against the wall the prevent entrapment between the bed and wall.
13. The use of water or sleep flotation mattresses is prohibited.
14. STRANGULATION HAZARD - Never attach or hang items to any part of the bunk bed that are not designed for use with the bed; for example, but not limited to, hook, belts and jump ropes.
15. Keep these instructions for future reference.
16. Prohibit more than one person on upper bunk

# ASSEMBLY INSTRUCTIONS

## **KEEP AI for future use**

1. At the beginning :

Tighten all hardware.

Check metal parts for rust. If found, sand and repaint using a nonlead-based paint meeting the requirements of 16 CFR 1303.

Check all wood members for deterioration and splinters. Sand down splinters and replace deteriorating wood members.

rake and check depth of loose fill protective surfacing materials to prevent compaction and to maintain appropriate depth. Replace as necessary.

2. Twice a month

3. Tighten all hardware.

4. Rake and check depth of loose fill protective surfacing materials to prevent compaction and to maintain appropriate depth. Replace as necessary.

5. Owners shall be responsible for maintaining the legibility of the warning labels.

6. Disposal instructions-

7. There shall be instructions advising the owner to disassemble and dispose of the playground equipment in such a way that in unreasonable hazards will exist at the time the playground equipment is discarded.

8. The instructions shall also include the information found in Section 4 of the United States Consumer Product Safety Commission's (USCPSC) Outdoor Home Playground Safety Handbook or specific surfacing guidelines for the product consistent with the USCPSC Handbook. A copy of this section may be found in Appendix X2.

9. Observing the following statements and warnings reduces the likelihood of serious or fatal injury.

10. Specifying the number and weight of occupants that may safely use the equipment singly or simultaneously.

11. Recommending on-site adult supervision for children of all ages.

12. Warning the owner to instruct children not to use the equipment in a manner other than intended.

13. Warning the owner to instruct children not to get off equipment while it is in motion.

14. Warning the owner not to allow children to wear inappropriate items, such as but not limited to, loose fitting clothing, hood and neck drawstrings, scarves, cord-connected items, capes and ponchos.

15. These items can cause death by strangulation.

16. Warning the owner to instruct children not to climb when the equipment is wet.

17. Aming the owner to instruct children not to attach items to the playground equipment that are not specifically designed for use with the equipment, such as, but not limited to, jump ropes, clothesline, pet leashes, cables and chain as they may cause a strangulation hazard.

18. Warning the owner to instruct children to remove their bike or other sports helmet before playing on the playground equipment.

19. Warning the owner to dress children with well-fitting and full foot enclosing footwear. Examples of inappropriate footwear are clogs, flip flops, and sandals.

20. Place the equipment on level ground, not less than 6 ft (1.8m) from any structure or obstruction such as a fence, garage, house, overhanging branches, laundry lines, or electrical wires.

21. Do not install home playground equipment over concrete, asphalt, packed earth, grass, carpet, or any other hard surface. A fall onto a hard surface can result in serious injury or death to the equipment user.





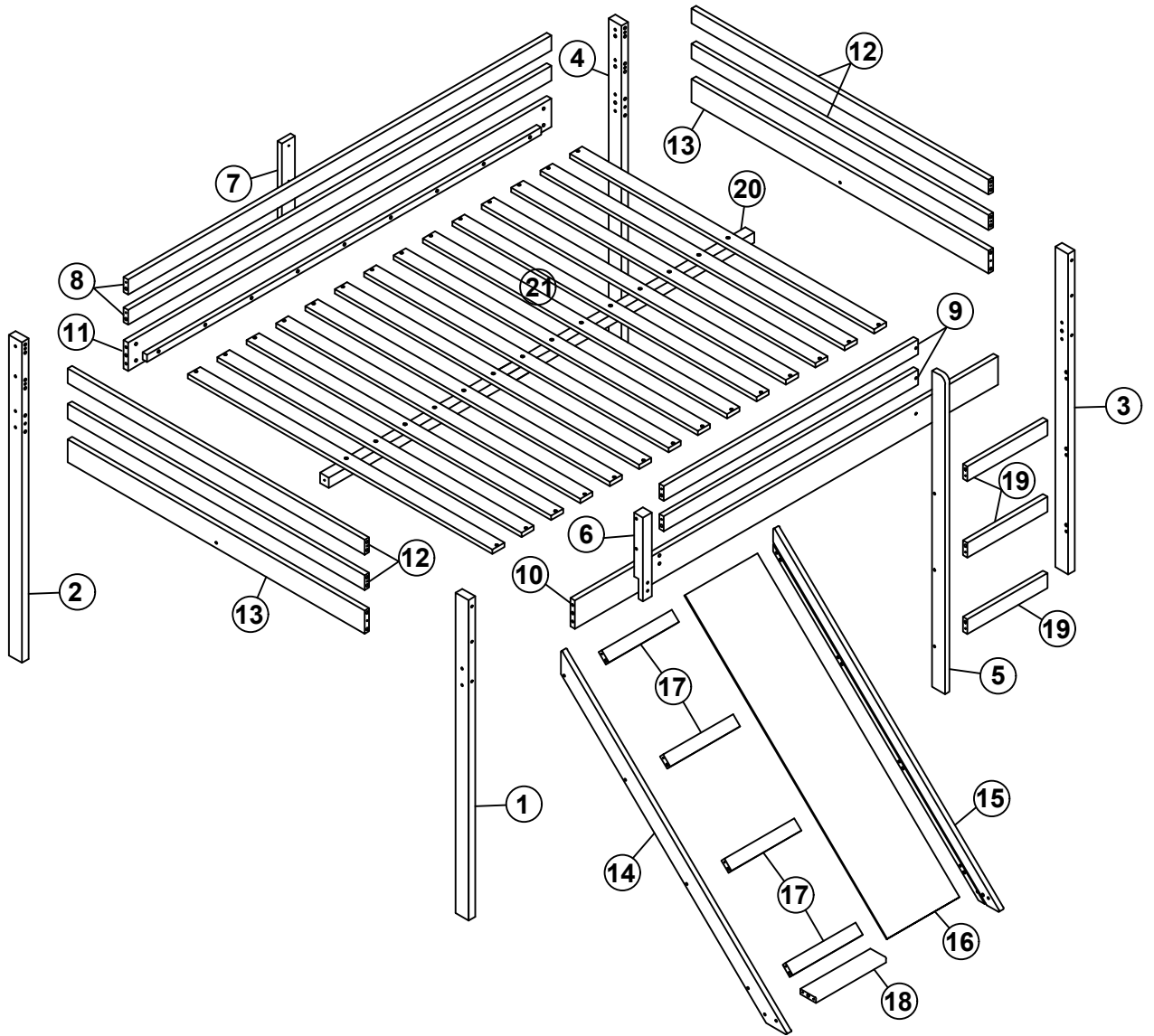

22. To prevent serious injury, cautionary statements shall be included which warn that children must not use the equipment until properly installed.

# ASSEMBLY INSTRUCTIONS

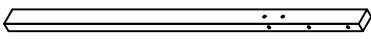
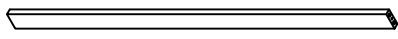
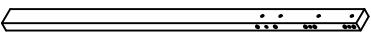
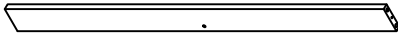
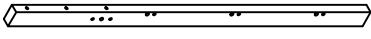

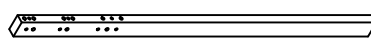
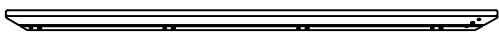
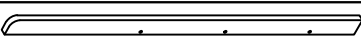

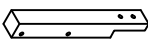
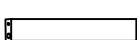
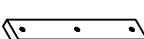
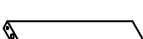
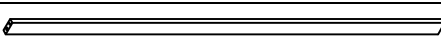
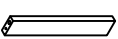
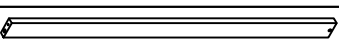
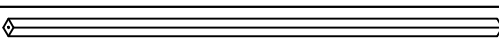

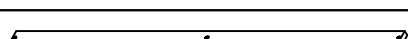
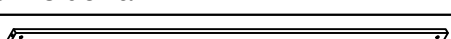





# ASSEMBLY INSTRUCTIONS

## PARTS LIST WF286242

<b>1</b>		1pc	<b>12</b>		4pcs
<b>2</b>		1pc	<b>13</b>		2pcs
<b>3</b>		1pc	<b>14</b>		1pc
<b>4</b>		1pc	<b>15</b>		1pc
<b>5</b>		1pc	<b>16</b>		1pc
<b>6</b>		1pc	<b>17</b>		4pc
<b>7</b>		1pc	<b>18</b>		1pc
<b>8</b>		2pcs	<b>19</b>		3pcs
<b>9</b>		2pcs	<b>20</b>		1pc
<b>10</b>		1pc	<b>21</b>		8pcs
<b>11</b>		1pc			



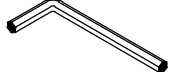

## HARDWARE LIST WF286242

<b>A</b>	Ø4x30		45PCS	<b>G</b>	1/4x75	 	8PCS
<b>B</b>	Ø4x15		6PCS	<b>I</b>	1/4x35	 	2PCS
<b>C</b>	6.5x100		12PCS	<b>J</b>	Ø10x40		50PCS
<b>E</b>	6.5x80		9PCS	<b>K</b>	70x18x2		2PCS
<b>F</b>	6.5x60		20PCS	<b>L</b>	4x58		1PC

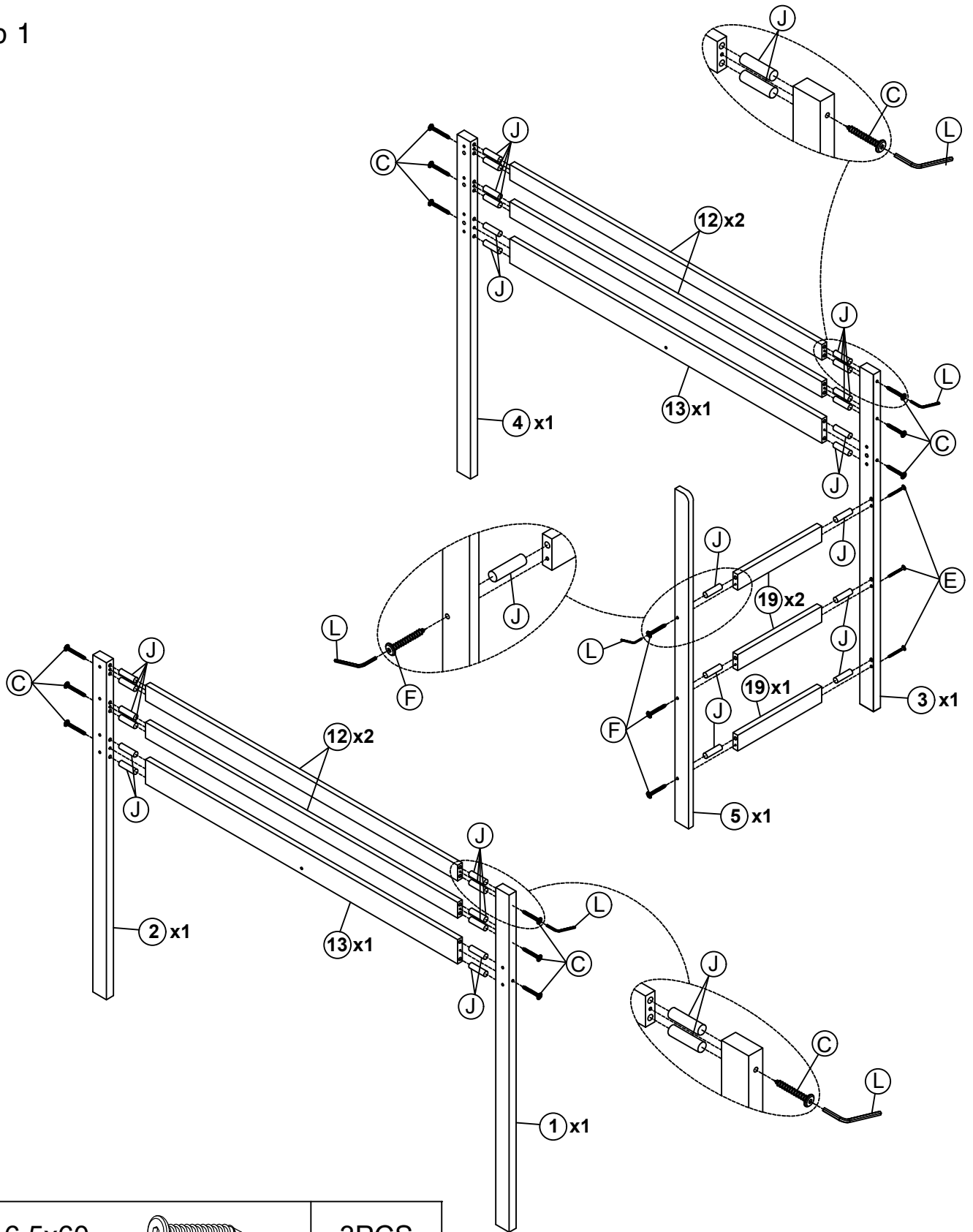
# ASSEMBLY INSTRUCTIONS

## Step 1







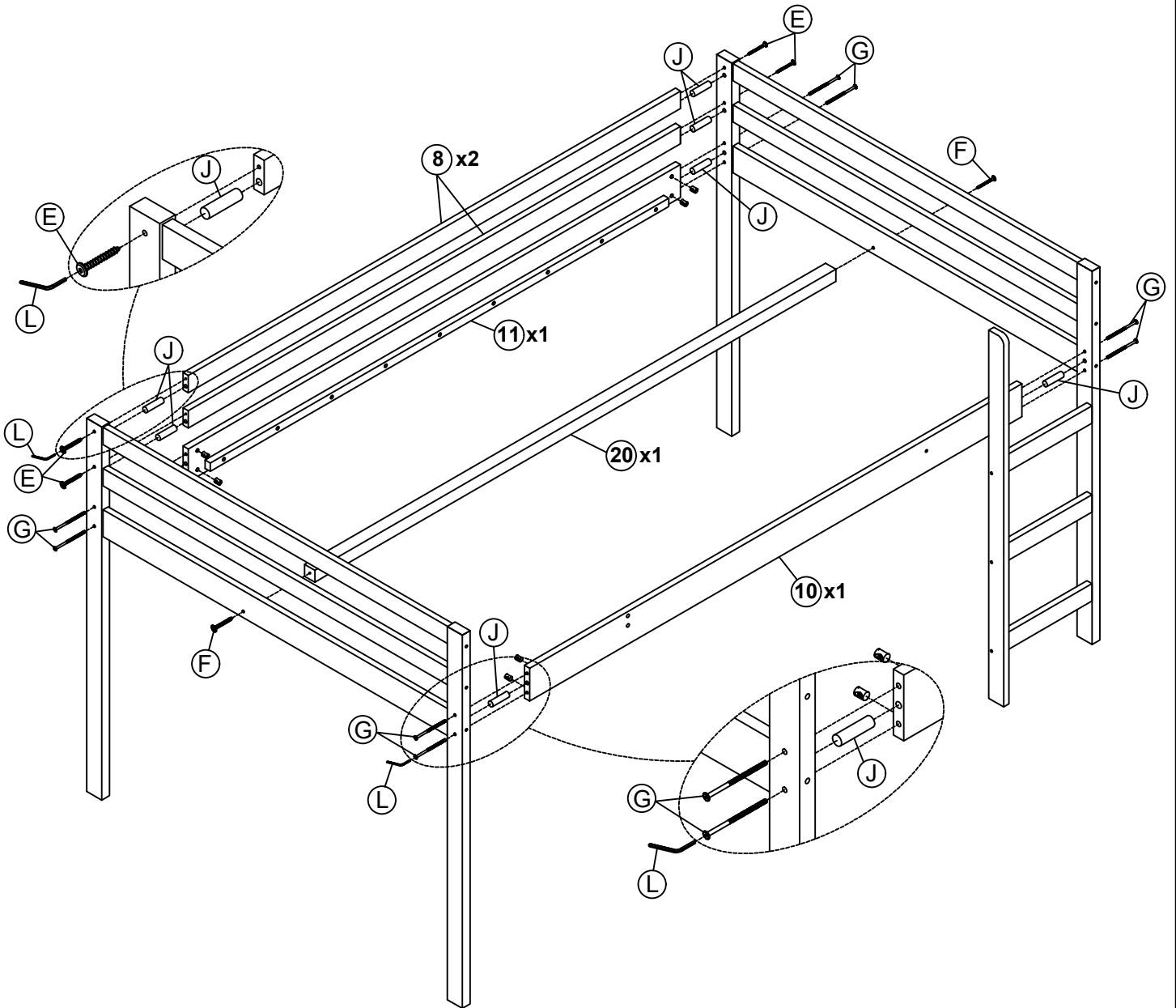

<b>F</b>	6.5x60		3PCS			
<b>L</b>	4x58		1PC	<b>E</b>	6.5x80 	3PCS
<b>J</b>	Ø10x40		30PCS	<b>C</b>	6.5x100 	12PCS

# ASSEMBLY INSTRUCTIONS

## Step 2





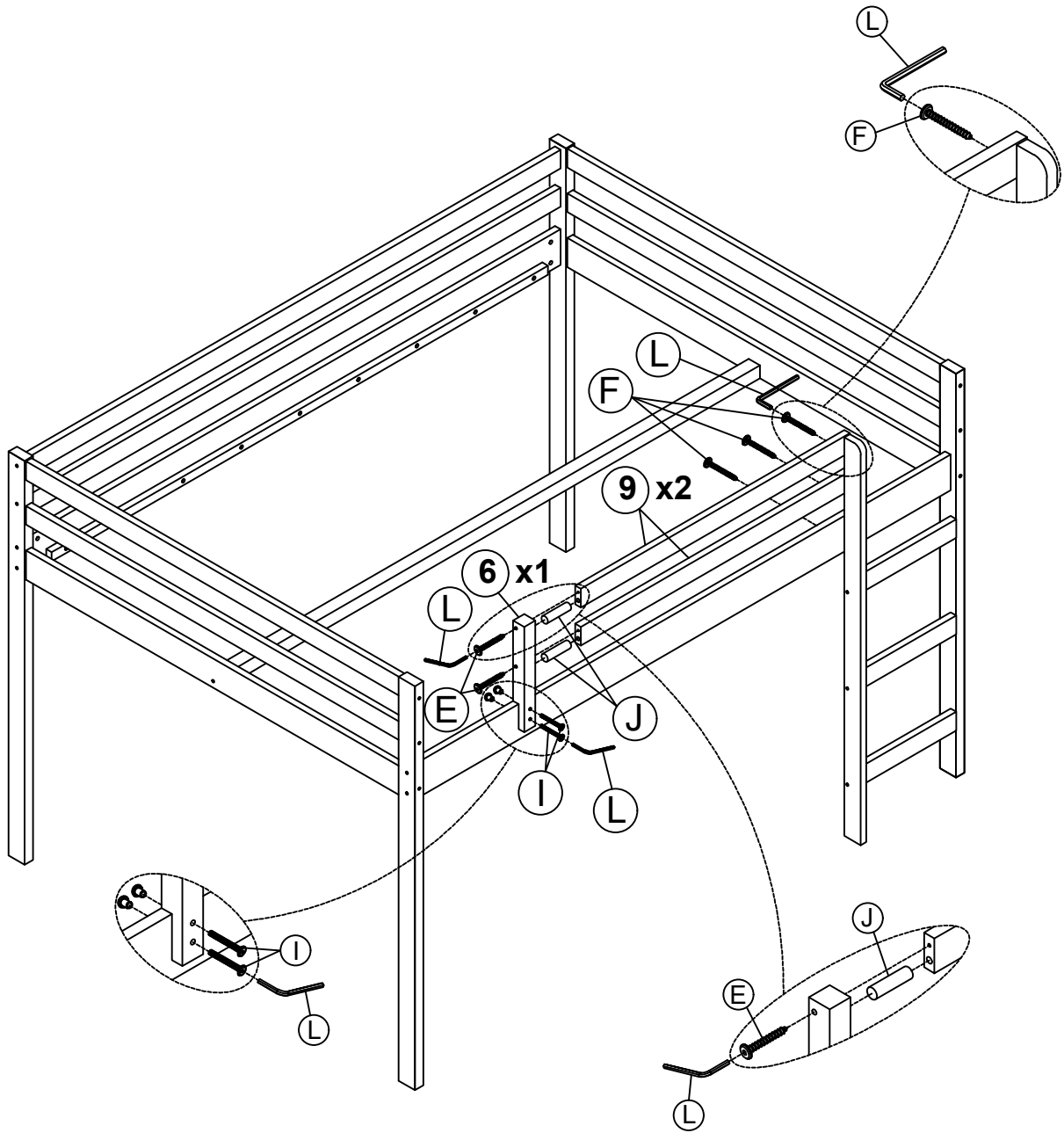

<b>L</b>	4x58		1PC	<b>G</b>	1/4x75			8PCS
<b>J</b>	Ø10x40		8PCS	<b>F</b>	6.5x60			2PCS
				<b>E</b>	6.5x80			4PCS

# ASSEMBLY INSTRUCTIONS

## Step 3



<b>L</b>	4x58		1PC	<b>I</b>	1/4x35		2PCS
<b>J</b>	Ø10x40		2PCS	<b>F</b>	6.5x60		3PCS
				<b>E</b>	6.5x80		2PCS



# ASSEMBLY INSTRUCTIONS

## Step 4

First attach 2pcs part 21 to the front and end of the frame between headboard.  
Then attach the remaining part 21 equidistantly between headboard.

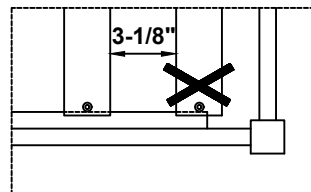
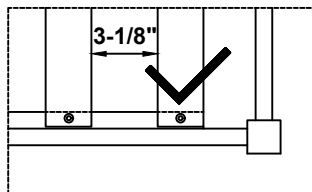
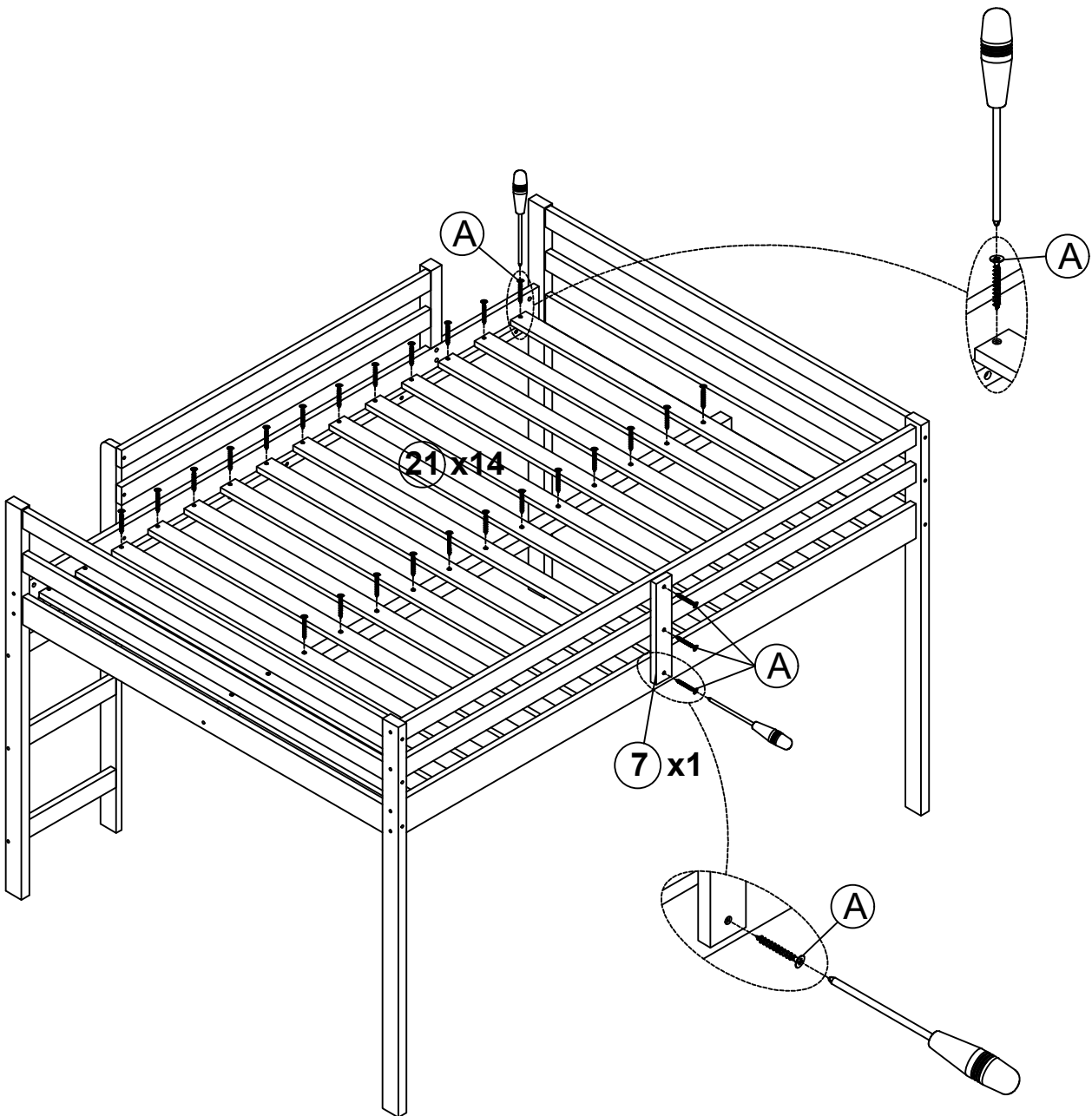

Note : Do not lock the screws of the bed slats to the outermost edge of the bed slats, you need to leave a certain space at the edges, otherwise it will cause the board to break.

**A**

Ø4x30



45PCS

