

TWIN LOFT BED
ASSEMBLY INSTRUCTIONS
SKU: FU284CPC-AN

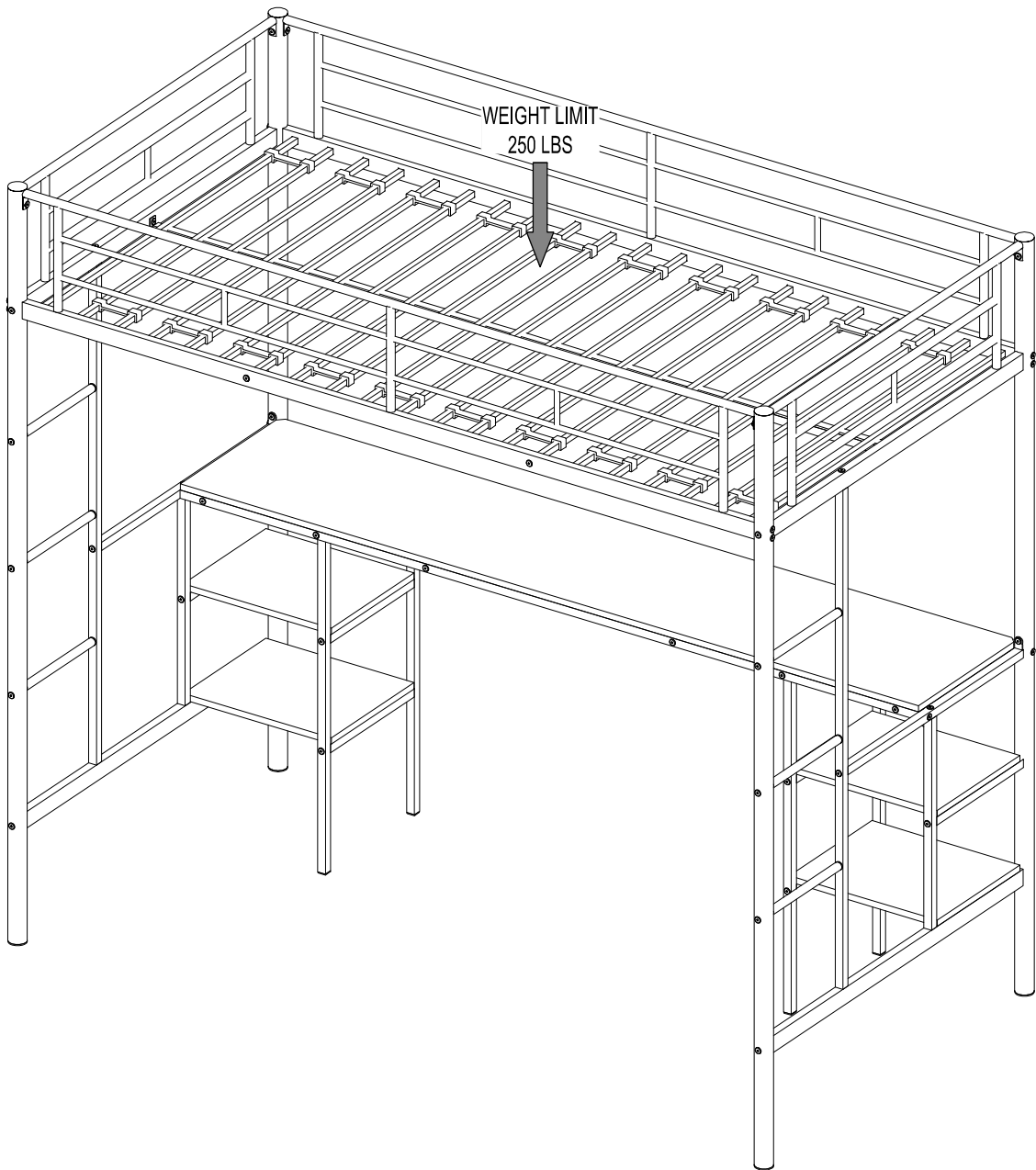

TWIN LOFT BED
ASSEMBLY INSTRUCTIONS
SKU: FU284CPC-AN

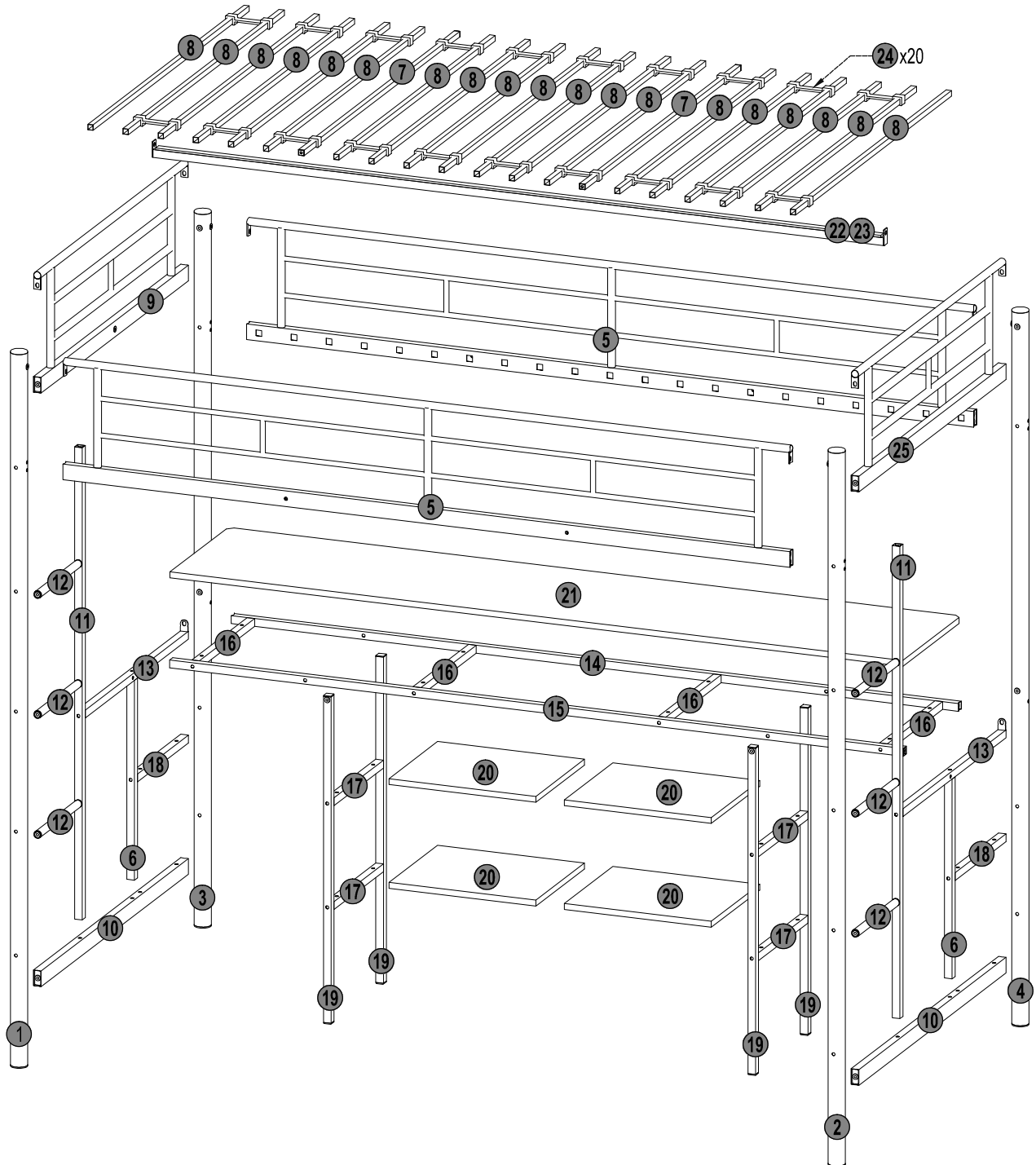



**TWIN LOFT BED
ASSEMBLY INSTRUCTIONS**
SKU: FU284CPC-AN

PART LIST





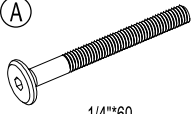
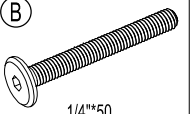
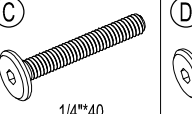
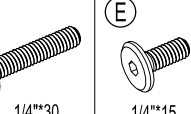

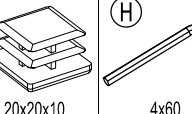
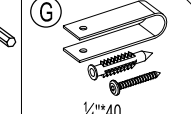
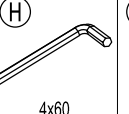
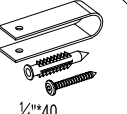













<p>①</p> <p>Holes might difference</p> <p>1 Pc</p>	<p>②</p> <p>Holes might difference</p> <p>1 Pc</p>	<p>③</p> <p>Holes might difference</p> <p>1 Pc</p>	
<p>④</p> <p>Holes might difference</p> <p>1 Pc</p>	<p>⑤</p> <p>2 Pcs</p>	<p>⑥</p> <p>Screw Hole</p> <p>2 Pcs</p>	
<p>⑦</p> <p>Screw Hole</p> <p>2 Pcs</p>	<p>⑧</p> <p>Hollow</p> <p>19 Pcs</p>	<p>⑨</p> <p>1 Pcs</p>	
<p>⑩</p> <p>2 Pcs</p>	<p>⑪</p> <p>Screw Hole</p> <p>2 Pcs</p>	<p>⑫</p> <p>Screw Hole</p> <p>6 Pcs</p>	
<p>⑬</p> <p>Screw Hole</p> <p>2 Pcs</p>	<p>⑭</p> <p>Screw Hole</p> <p>1 Pc</p>	<p>⑮</p> <p>Screw Hole</p> <p>1 Pc</p>	
<p>⑯</p> <p>Screw Hole</p> <p>4 Pcs</p>	<p>⑰</p> <p>Screw Hole</p> <p>4 Pcs</p>	<p>⑱</p> <p>Screw Hole</p> <p>2 Pcs</p>	
<p>⑲</p> <p>Screw Hole</p> <p>4 Pcs</p>	<p>⑳</p> <p>4 Pcs</p>	<p>㉑</p> <p>chamfered corners</p> <p>chamfered corners</p> <p>1 Pc</p>	
<p>㉒</p> <p>1 Pc</p>	<p>㉓</p> <p>EVA Self adhesive tape</p> <p>1 Pc</p>	<p>㉔</p> <p>20 Pcs</p>	<p>㉕</p> <p>1 Pcs</p>

**TWIN LOFT BED
ASSEMBLY INSTRUCTIONS**
SKU: FU284CPC-AN

HARDWARE LIST

 (A) 1/4**60 32 Pcs	 (B) 1/4**50 4Pcs	 (C) 1/4**40 24 Pcs	 (D) 1/4**30 30 Pcs	 (E) 1/4**15 16 Pcs	 (F) ø42x10 8 Pcs	 (K) 20x20x10 4 Pcs	 (H) 4x60 2 Pcs	 (G) 1/4**40 2 Set
---	--	--	--	---	--	--	--	---

SAFETY WARNING AND GENERAL NOTES

-  Follow the information on the warnings on the loft bed end structure and on the carton. Do not remove the warning label from the bed.
 -  Always use the recommended size mattress on the mattress support, or both, to help prevent the likelihood of entrapment or falls.
 -  Do not allow children under 6 years old to use the upper bunk.
 -  Periodically check and ensure the guardrail, ladder and other components are in their proper position, free from damage, and all connectors are tight.
 -  Do not allow horseplay on or under bed.
 -  Always prohibit jumping on the bed.
 -  Prohibit more than one person on upper bed.
 -  Always use the ladder for entering and leaving the upper bed.
 -  Do not use substitute parts. Contact the manufacturer or dealer for replacement parts.
 -  Use of a night-light may provide added safety precaution for a child using the upper bunk.
 -  Always use guardrails on both long sides of the upper bunk.
 -  If the bunk bed will be placed next to a wall, the guardrail that runs the full length of the bed should be placed against the wall to prevent entrapment between the bed and the wall.
The use of water of sleep flotation mattress is prohibited.
 -  **STRANGULATION HAZARD** - Never attach or hang items to any part of the loft bed that are not designed for use with the bed; for example, but not limited to, hook, belts and jump ropes.
 -  Keep these instructions for future reference.
 -  We recommended assembling your loft bed on the shipping carton to protect your floor or carpet.
 -  Be certain all staples are out of the box before beginning assembly on the shipping carton.
 -  **USE ONLY MATTRESSES WHICH ARE AS THE TABLE BELOW ON UPPER BUNK.**
- | Bed type | Length | Width | Thickness |
|----------|-----------|-------|-----------|
| Twin | 74" - 75" | 38½" | 6" max |
-  **SURFACE OF MATTRESS MUST BE AT LEAST 5" (127MM) BELOW THE UPPER EDGE OF GUARDRAILS.**
 -  Replacement Parts:
Replacement Parts, including additional guardrails, may be obtained from any of our dealers.
 -  Plastic lock can help reduce squeaky noise of metal bed but needs time and effort to set up, please use accordingly to your need.
 -  Please, do not tighten any screw before each assembling unit is well placed AT appropriate position.

TWIN LOFT BED
 ASSEMBLY INSTRUCTIONS
 SKU: FU284CPC-AN

STEP 1

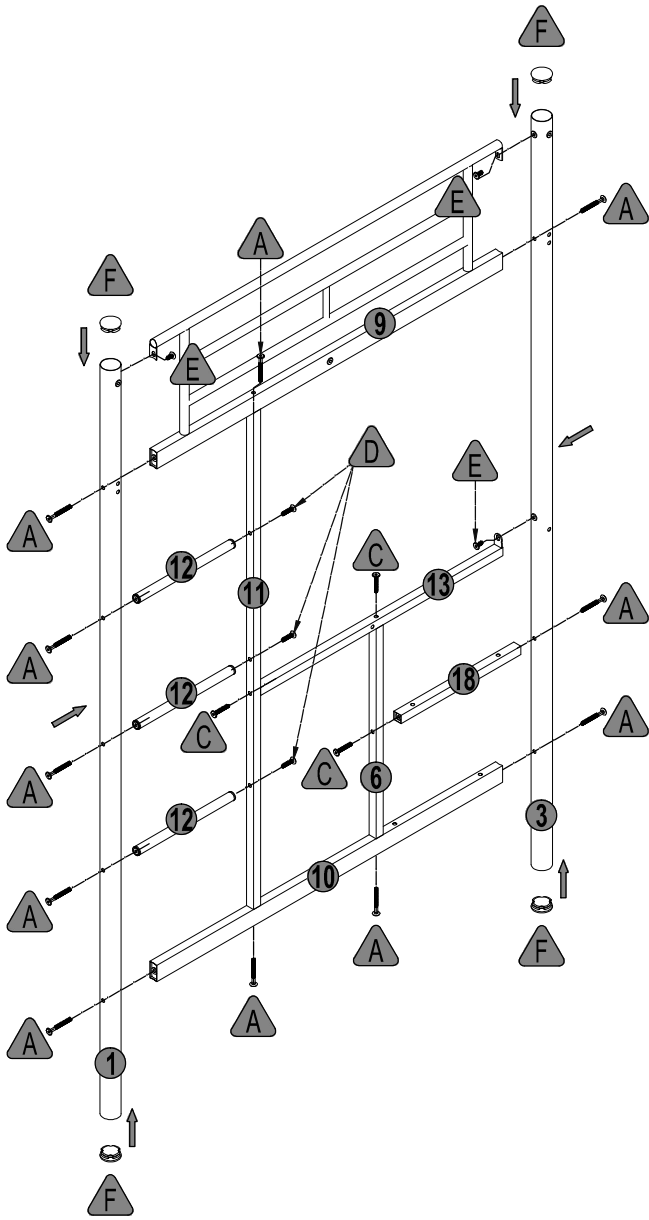

STEP 2

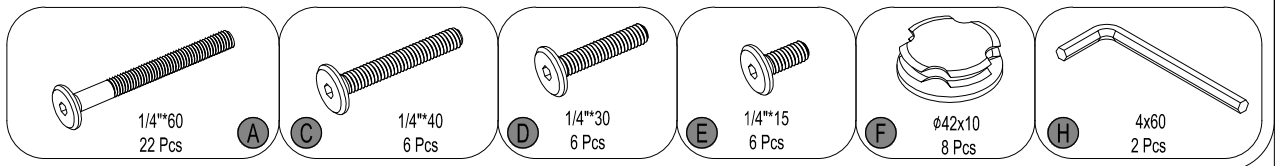
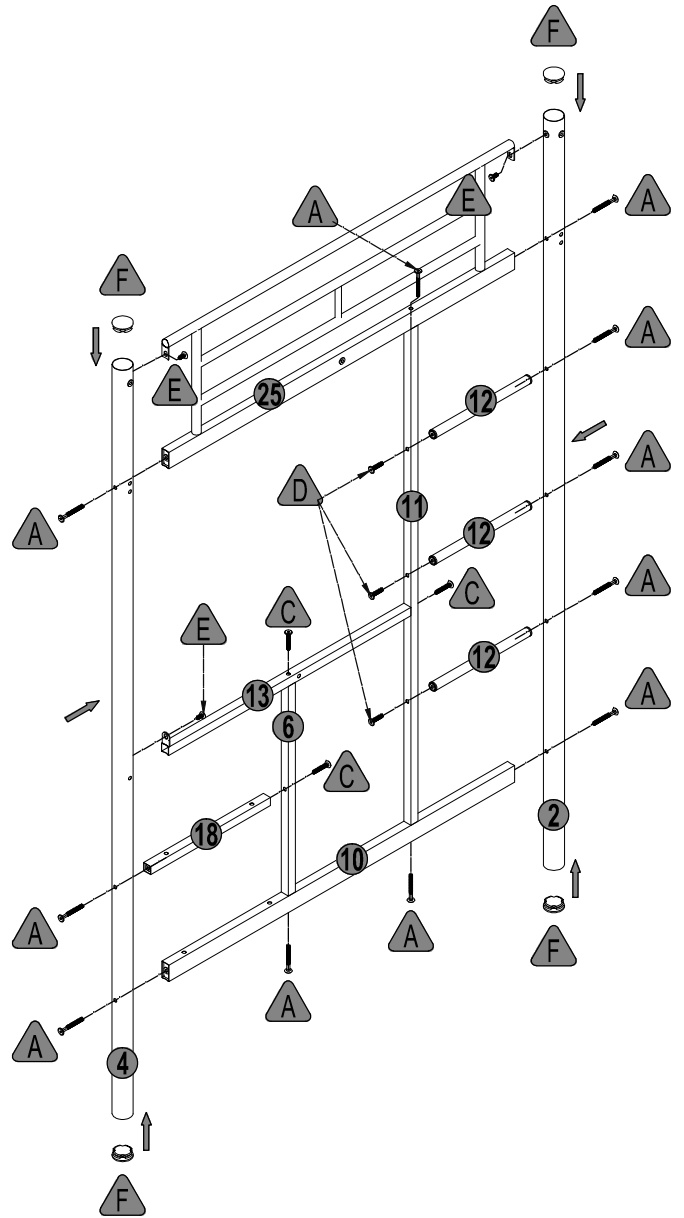

TWIN LOFT BED
ASSEMBLY INSTRUCTIONS
SKU: FU284CPC-AN

STEP 3

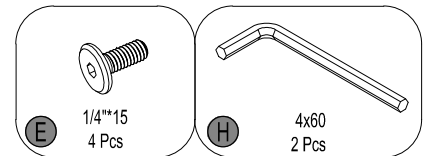
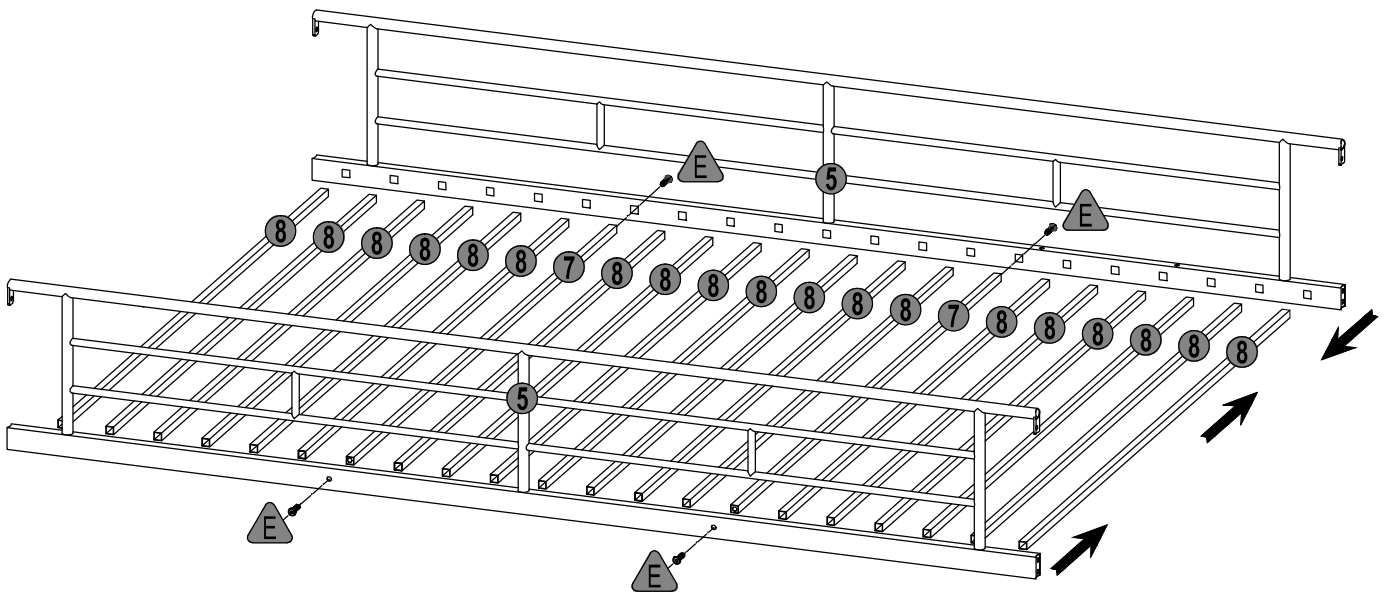

STEP 4

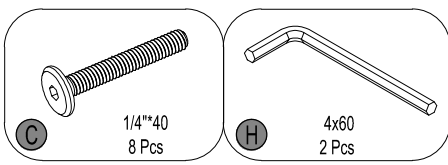
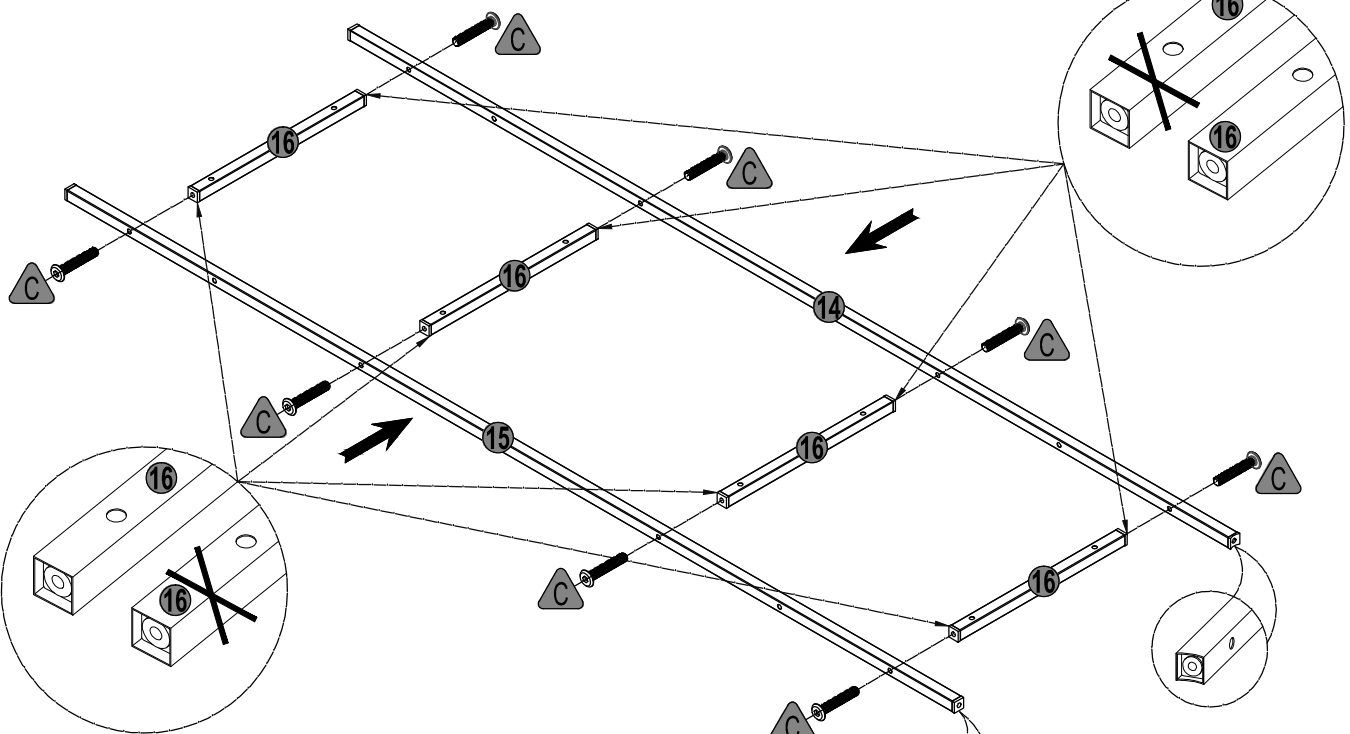

TWIN LOFT BED
ASSEMBLY INSTRUCTIONS
SKU: FU284CPC-AN

STEP 5

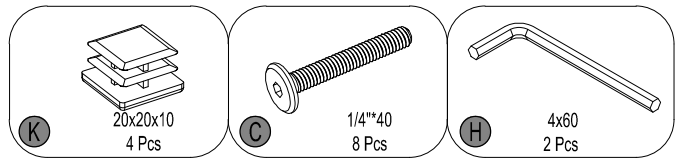
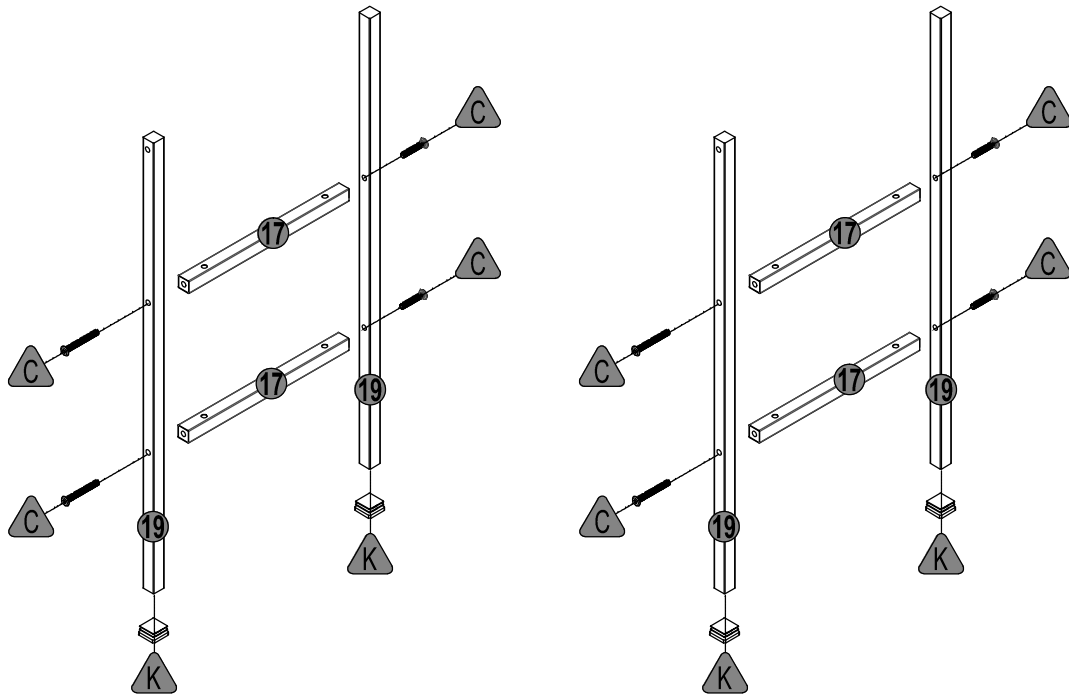

STEP 6

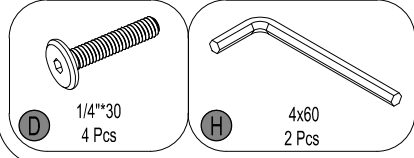
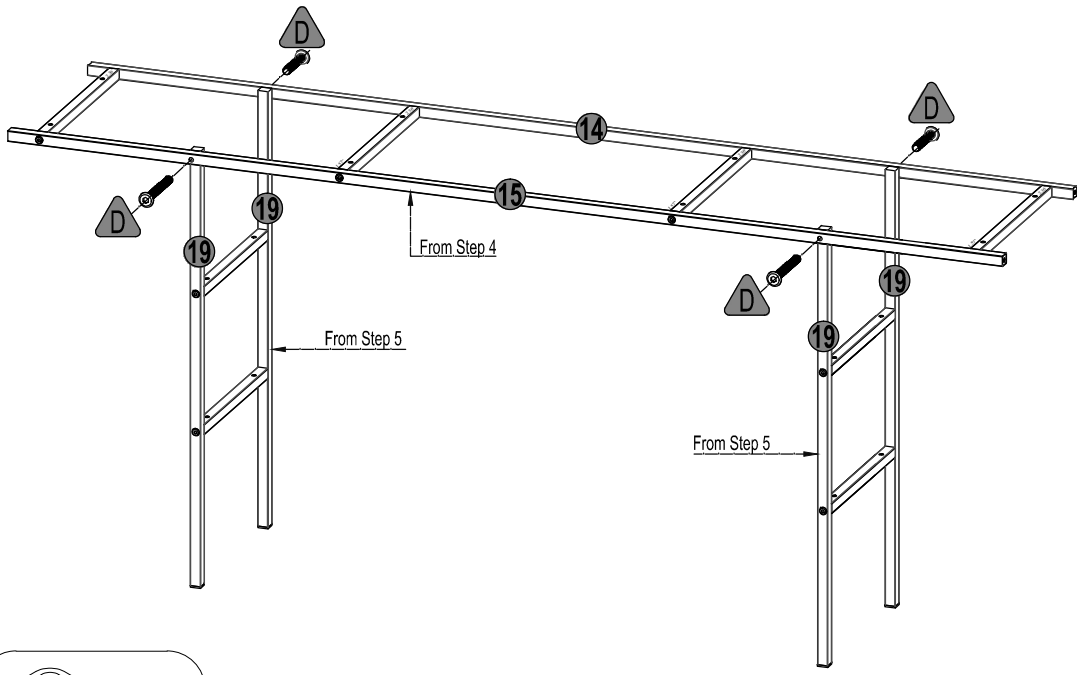

TWIN LOFT BED
 ASSEMBLY INSTRUCTIONS
 SKU: FU284CPC-AN

STEP 7

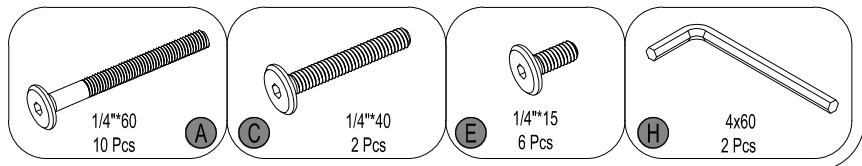
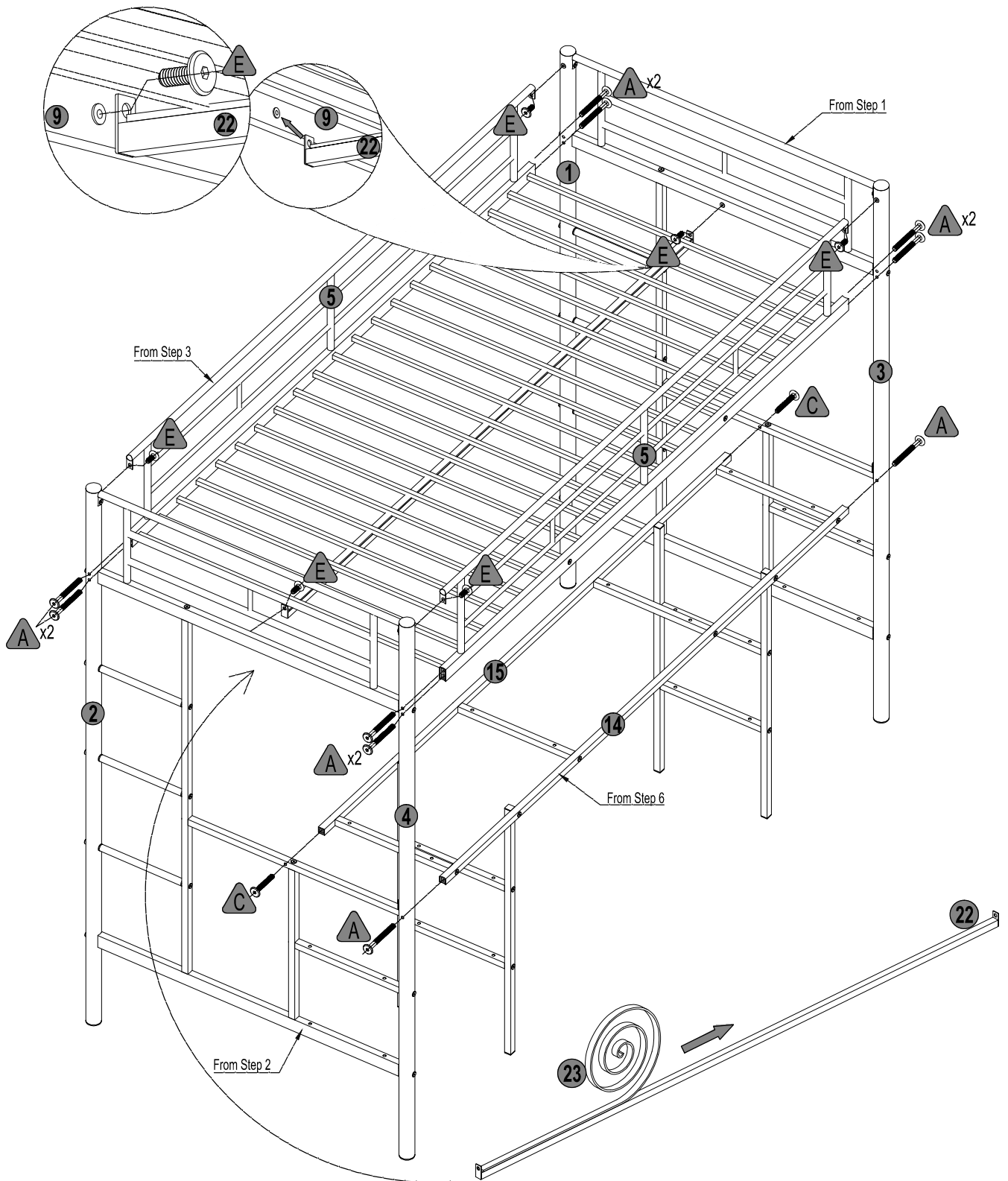

TWIN LOFT BED
ASSEMBLY INSTRUCTIONS
SKU: FU284CPC-AN

STEP 8

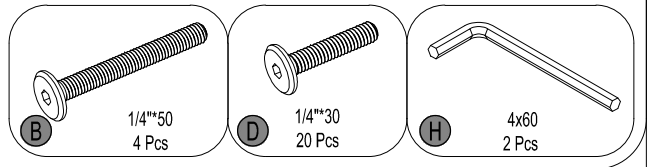
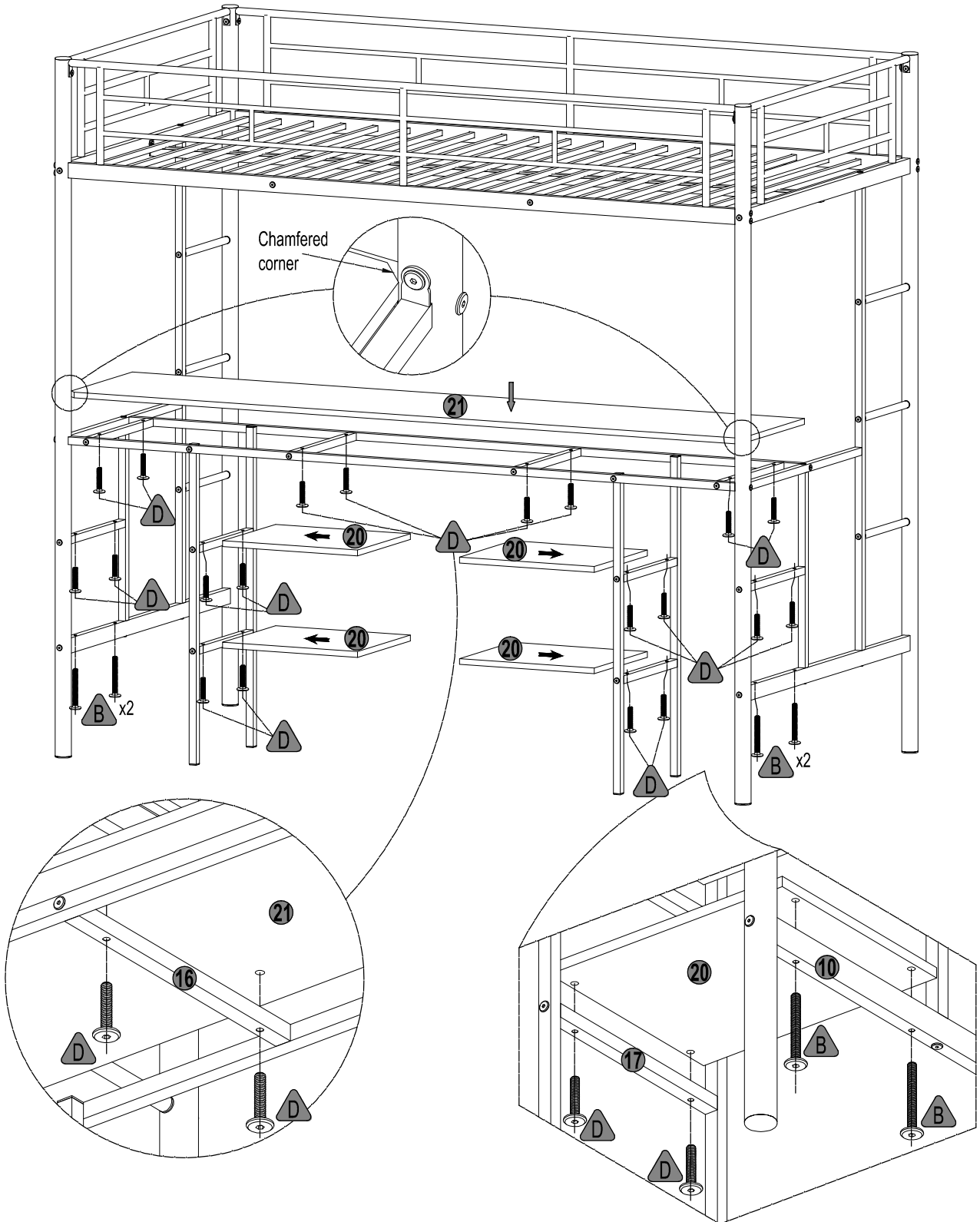

TWIN LOFT BED
ASSEMBLY INSTRUCTIONS
SKU: FU284CPC-AN

STEP 9

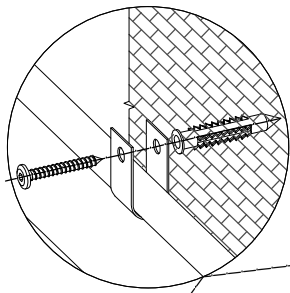

Firmly attaching the bed to wall before use for stability and horizontal flip preventing.

